

Stabilization/Solidification of CERCLA and RCRA Wastes

Physical Tests, Chemical Testing
Procedures, Technology Screening, and
Field Activities

Center for Environmental Research Information
and
Risk Reduction Engineering Laboratory
Office of Research and Development
U.S. Environmental Protection Agency
Cincinnati, OH 45268

Disclaimer

This document has been reviewed in accordance with U.S. Environmental Protection Agency policy and approved for publication. Mention of trade names or commercial products does not constitute endorsement or recommendation for use.

Contents

	Page
Figures	vi
Tables	viii
Acknowledgments	ix
1. Introduction	
1.1 Purpose of handbook	1-1
1.2 Terminology and definitions	1-1
1.3 Handbook overview	1-1
2. The Basis for Stabilization/Solidification	
2.1 Resource Conservation and Recovery Act (RCRA)	2-1
2.2 Hazardous and Solid Waste Amendments (HSWA)	2-1
2.3 The Comprehensive Environmental Response, Compensation, & Liability Act (CERCLA)	2-3
2.4 Superfund Amendments and Reauthorization Act (SARA)	2-3
3. State of the Art Stabilization/Solidification Processes	
3.1 Process overview of stabilization/solidification technology	3-1
3.1.1 Inorganic stabilization/solidification	3-1
3.1.2 Organic stabilization/solidification	3-2
3.2 Stabilization/solidification activity in the various U.S. Environmental Protection Agency regions	3-3
4. Physical Tests to Characterize Wastes Before and After Stabilization/Solidification	
4.1 Index property testing	4-1
4.1.1 Particle size analysis	4-1
4.1.2 Atterberg limits	4-5
4.1.3 Moisture content	4-6
4.1.4 Suspended soils	4-7
4.1.5 Paint filter test	4-7
4.2 Density testing	4-8
4.2.1 Bulk density— Drive-cylinder method	4-8
4.2.2 Bulk density—Sand-cone method	4-8
4.2.3 Bulk density—Nuclear method	4-8
4.2.4 Bulk density—Stabilized waste	4-8

4.3	Compaction testing—moisture-density relations of soil-cement mixtures	4-9
4.3.1	Test description	4-9
4.3.2	Interpretation & application of results	4-9
4.4	Permeability (hydraulic conductivity) testing	4-10
4.5	Strength testing	4-12
4.5.1	Unconfined compressive strength of cohesive soils	4-12
4.5.2	Unconfined compressive strength of cylindrical cement specimens	4-13
4.5.3	Flexural strength	4-15
4.5.4	Cone index	4-16
4.6	Durability testing	4-16
4.6.1	Freezing & thawing test of solid waste	4-17
4.6.2	Wetting & drying test of solid wastes	4-17
4.6.3	Interpretation & application of results of durability tests	4-17
5.	Chemical Testing Procedures	
5.1	Overview of leaching mechanisms and leach tests	5-1
5.1.1	Leaching mechanisms	5-1
5.1.2	Leaching/extraction tests	5-3
5.2	Leach test methods and applications	5-4
5.2.1	Toxicity characteristic leaching procedure	5-5
5.2.2	Extraction procedure toxicity test	5-6
5.2.3	California waste extraction procedure	5-6
5.2.4	Multiple extraction procedure	5-6
5.2.5	Monofill waste extraction procedure	5-7
5.2.6	Equilibrium leach test	5-7
5.2.7	Acid neutralization capacity	5-7
5.2.8	Sequential extraction test	5-8
5.2.9	Sequential chemical extraction test	5-8
5.2.10	Materials characterization center static leach test	5-8
5.2.11	American Nuclear Society leach test	5-8
5.2.12	Dynamic leach test	5-10
5.3	Experimental factors affecting results and interpretation	5-10
5.4	Leach test selection and interpretation	5-11
6.	Technology Screening	
6.1	Application of technology screening	6-1
6.1.1	Waste screening	6-4
6.1.2	Waste characterization	6-6
6.1.3	Feasibility testing	6-7
6.1.4	Site evaluation	6-8
6.1.5	Cost evaluation	6-9
6.2	Summary	6-9

7. Field Activities

7.1 Stabilization/solidification functions and processes	7-1
7.1.1 Waste removal	7-1
7.1.2 Untreated waste transportation	7-2
7.1.3 Untreated waste storage	7-3
7.1.4 Chemical reagent storage	7-4
7.1.5 Waste/reagent mixing	7-4
7.1.6 Stabilized/solidified waste transportation	7-4
7.1.7 Stabilized/solidified waste replacement	7-6
7.1.8 In situ processes	7-7
7.2 Stabilization/solidification of materials by lime stabilization techniques	7-10
7.3 Site conditions	7-11
7.3.1 Waste type	7-12
7.3.2 Land use and safety	7-12
7.3.3 Geography	7-12
7.3.4 General	7-12

References	R-1
------------	-----

Figures

Number		Page
2-1	BDAT treatment standards for waste codes based on stabilization	2-4
4-1	Typical particle-size grading curve	4-4
4-2	Illustration of material gradation	4-5
4-3	Typical soil-cement moisture/density relationship	4-9
4-4	Basic layout of apparatus for falling-head permeability test	4-10
4-5	Basic layout of apparatus for constant-head permeability apparatus	4-11
4-6	Stress-strain curve	4-12
4-7	Schematic of apparatus for flexure test of soil-cement by third-point loading method	4-15
4-8	Photograph of a pocket penetrometer	4-16
5-1	Relationship between velocity of leaching solution and the leaching rate	5-4
5-2	Acid neutralization capacity for several stabilized/solidified synthetic sludge samples	5-7
5-3	Sequential extraction test results (a) as a function of pH and alkalinity, and (b) as a function of total metal and alkalinity for cement-based waste forms	5-9
5-4	Schematic plot of cumulative fraction leached vs. the square root of time	5-10
6-1	Technology screening flowchart for stabilization/solidification	6-5
7-1	Photograph of tracked backhoes and draglines in operation at a hazardous waste site	7-3
7-2	Photographs of backhoe mixing of sludge and lime	7-5
7-3	Photograph of a soil-bentonite mixing plant using a pug mill	7-6
7-4	Photograph of unlined dump truck being loaded with lime stabilized/solidified sludge	7-7

7-5	Chart used to select equipment for compaction of various-sized media	7-8
7-6	Crane-mounted mixing system advancing through unstabilized/unsolidified sludge layer	7-9
7-7	Photograph of ENRECO backhoe equipped with stabilizing/solidifying agent injector	7-9
7-8	Photograph of a sheepfoot roller being used for compaction	7-11

Tables

Number		Page
3-1	Solidification case studies	3-4
4-1	Physical testing methods	4-2
4-2	Liquid waste consistency classification	4-7
4-3	Unconfined compressive strength conversion factors	4-14
5-1	General chemical test methods that may also have application to stabilized/solidified wastes	5-2
5-2	Extraction tests	5-5
5-3	Summary of procedural differences between EP TOX and TCLP	5-6
6-1	Effect of waste components on stabilization/solidification	6-2

ACKNOWLEDGMENTS

This handbook was developed under Contract No. 68-03-3413, Work Assignment Nos. 0-26 and 1-26, to the U.S. Environmental Protection Agency. The authors were Mr. Michael M. Arozarena, Ms. Jan L. Zieleniewski, and Mr. Majid Dosani with PEI Associates, Inc., and Mr. H. Robert Maxey, P.E.; Ms. Sarah A. Hokanson; Ms. Christine A. Pryately; Mr. Timothy Whipple; and Mr. Robert Kravitz with Earth Technology Corporation. Mr. Maxey and his associates contributed the bulk of the technical input to this handbook, and their dedication to this project is greatly appreciated. The handbook was edited by Ms. Martha H. Phillips of PEI Associates.

The project was conducted under the management supervision of Mr. Clarence A. Clemons. Technical direction and supervision were provided by Mr. Edwin F. Barth and Mr. Paul de Percin.

Development of the handbook involved the participation of the following reviewers, whose comments contributed greatly to its quality:

Dr. Paul L. Bishop	University of Cincinnati
Mr. Jesse R. Connor	Chemical Waste Management, Inc.
Mr. Pierre L. Cote'	Environment Canada, Wastewater Technology Center
Mr. M. John Cullinane, Jr., P.E.	U.S. Army Corps of Engineers, Waterways Experiment Station
Dr. John W. Liskowitz	New Jersey Institute of Technology
Dr. Frank R. Prince	American Petroleum Institute
Dr. R. Soundararajan	RMC Environmental and Analytical Laboratories
Dr. Steven I. Taub, P.E.	CECO Filters, Inc.

We would also like to acknowledge Mr. Kenneth Gutschick, Mr. David Musser, and Mr. Steven Day with the National Lime Association, ENRECO Company, and Geo-Con Company, respectively, for their technical contributions to this handbook. We would also like to acknowledge PEI graphics artist Ms. Joy Wallace, who performed the desktop publishing of this document.

Section 1

Introduction

1.1 Purpose of Handbook

The primary purpose of this handbook is to provide the U.S. Environmental Protection Agency (EPA) regional staff responsible for reviewing CERCLA remedial action plans and RCRA permit applications with a tool for interpreting information on stabilization/solidification treatment. As a practical day-to-day reference guide, it will provide the EPA staff and others with a quick update on particular aspects of stabilization/solidification. It also contains more detailed information on specific subjects and a complete list of recent references.

In general, this handbook should prove useful to all technical and professional people working in the stabilization/solidification field, including State environmental protection agencies, private industry, commercial treatment and disposal facilities, and environmental consultants. Not only does it cover a wide range of applications, it has been written to bring the less-experienced professional up to speed quickly while providing detailed information in many of the more technical areas.

1.2 Terminology and Definitions

In the literature, several terms are used to describe the stabilization/ solidification of hazardous waste, and the meaning of these terms is often not clear to the reader. In this handbook, the meanings of the terms "stabilization" and "solidification" are as defined in the EPA publication "Guide to the Disposal of Chemically Stabilized and Solidified Waste" (Malone et al. 1980). Both stabilization and solidification refer to treatment processes that are designed to accomplish one or more of the following: 1) improve the handling and physical characteristics of the waste, as in the sorption of free liquids; 2) decrease the surface area of the waste mass across which transfer or loss of contaminants can occur; and 3) limit the solubility of any hazardous constituents of the waste, e.g., by pH adjustment or sorption phenomena.

The preliminary benefit of stabilization techniques is that they limit the solubility or mobility of the contaminants with or without changing or improving the physical characteristics of the waste. Stabilization usually involves adding materials that will ensure that the hazardous constituents are maintained in their least mobile or toxic form. The addition of lime or sulfide to a metal hydroxide waste to precipitate the metal ions or the addition of a sorbent to an organic waste are examples of stabilization techniques.

Solidification implies that the beneficial results of treatment are obtained primarily, but not necessarily exclusively, through the production of a solid block of waste material with high structural integrity—a product often referred to as a "monolith." (In many cases, a monolith is not the end product of the stabilization/solidification process; however, after placement, the materials may continue to cure into a facsimile of a monolith.) The monolith can encompass the entire waste disposal site—called a "monofill"—or be as small as the contents of a steel drum. The contaminants do not necessarily interact chemically with reagents. Instead, they are mechanically locked within the solidified matrix. This is known as "microencapsulation." Contaminant loss is limited largely by decreasing the surface area exposed to the environment and/or isolating the contaminants from environmental influences by microencapsulating the waste particles. Wastes can also be "macroencapsulated," that is, bonded to or surrounded by an impervious covering. These techniques are also considered to be stabilization/solidification processes.

The term "fixation" has fallen in and out of favor, but it is widely used in the waste treatment field to mean any of the stabilization/solidification processes just described. "Fixed" wastes are those that have been treated in this manner. The term "immobilization" refers to those techniques that tend to decrease the concentration of toxic compounds by attaching them onto the surfaces of the solid particles.

Both solidification and chemical stabilization are usually included in commercial processes and result in the transformation of liquids or semisolids into environmentally safer forms. For example, a metal-rich sludge would be considered stabilized if it were mixed with a dry sorber such as fly ash or dry soil. If the sorbent and waste were then cemented into an impermeable, monolithic block, benefits would be even greater. In this handbook, the terminology used most often is stabilization/solidification (Cullinane et al. 1986).

1.3 Handbook Overview

This handbook has been written and organized to provide the reader with an informative, yet quick reference-type handbook that can be used by environmental professionals. Section 2 addresses the basis for the stabilization/solidification of hazardous waste and includes a discussion of the Resource Conservation and

Recovery Act (RCRA); the Hazardous and Solid Waste Amendments of 1984 (HSWA); the Comprehensive Environmental Response, Compensation, and Liability Act of 1980 (CERCLA); and the Superfund Amendments Reauthorization Act (SARA) and their requirements with regard to stabilization/ solidification processes. Section 3 presents state-of-the-art stabilization/solidification technologies. Section 4 discusses in depth the physical testing methods used to characterize solid and hazardous wastes before and after stabilization/solidification.

Section 5 addresses chemical testing procedures and includes an overview of leaching mechanisms, leach test methods and applications, factors affecting results, and the selection and interpretation of leach tests. Section 6 provides information on technology screening. Finally, Section 7 discusses the proper application of stabilization/solidification processes and the site conditions that can determine if a particular stabilization/solidification process is appropriate.

Section 2

The Basis for Stabilization/Solidification

Stabilization/solidification is a proven technology for the treatment of hazardous wastes and hazardous waste sites. Technical reasons for the selection of stabilization/solidification as a remediation technology include:

- It improves the handling and physical characteristics of the wastes; e.g., sludges are processed into solids.
- It reduces transfer or loss of contained pollutants by decreasing the surface area.
- It reduces pollutant solubility in the treated waste, generally by chemical changes.
- Techniques for processing sludges are well established; however, they are not set for soils and debris.
- Residues from the treatment of hazardous wastes by physical/chemical, biological, or incineration technologies can be further treated by stabilization/ solidification.
- Because of excavation problems, in situ treatment by stabilization/solidification is the only viable management technique in many cases.
- Alternate hazardous waste treatment and disposal techniques are often economically prohibitive.

Thus, stabilization/solidification has considerable technical merit. Selection of stabilization/solidification as a remediation technology is also supported by recent developments in the environmental regulations. The remainder of this section addresses the Resource Conservation and Recovery Act; the Hazardous and Solid Waste Amendments; the Comprehensive Environmental Response, Compensation, and Liability Act; and the Superfund Amendments as they pertain to the stabilization/solidification of hazardous waste.

2.1 Resource Conservation and Recovery Act (RCRA)

The disposal of hazardous liquid, sludge, or semisolid waste has been a controversial issue since the passage of RCRA in 1976. Prior to RCRA the disposal of liquid waste, other than by underground injection, was regulated under the authority of the Clean Water Act or controlled through State laws. The first liquid-waste-disposal regulations proposed under RCRA in December

1979 brought reactions ranging from suggestions that no restrictions were needed to demands that land disposal of liquids be banned entirely. The EPA believed that bulk liquids, sludge, and semisolid wastes could be placed in a landfill under certain controlled conditions, such as with a secure liner and a system for the collection and removal of leachate. If these measures were not available, EPA required treatment by mixing the waste with materials such as soil, fly ash, or cement kiln dust to stabilize or solidify the waste to ensure that free liquids were no longer present. (Free liquids are defined as liquids that readily separate from the solid portion of a waste under ambient temperature and pressure.) Biodegradable stabilizers were not recommended because their long-term effectiveness was unproven (U.S. EPA 1980a).

2.2 Hazardous and Solid Waste Amendments (HSWA)

During the early 1980's, EPA proposed additional regulations to control the disposal of liquid waste. These included the use of a paint filter test to determine the presence of free liquids in sludges, semisolids, slurries, and other wastes. They were particularly concerned with the disposal of containerized liquid wastes because of possible leachate generation and subsidence of the final landfill cover as a result of container degradation (U.S. EPA 1982). On November 8, 1984, the Hazardous and Solid Waste Amendments (HSWA) to RCRA were signed into law. These amendments significantly expanded both the scope and the requirements of RCRA and specifically addressed the issue of liquid waste disposal. Section 3004(c)(1) of HSWA states:

“Effective 6 months after the date of enactment of the Hazardous and Solid Waste Amendments of 1984, the placement of bulk or noncontainerized liquid hazardous waste or free liquids contained in hazardous waste (whether or not absorbents have been added) in any landfill is prohibited.”

This Congressionally mandated, absolute ban on the placement of bulk liquids in a landfill for any purpose or length of time, regardless of the presence of liners or leachate collection systems, was effective May 8, 1985.

Section 3004(c)(2) of HSWA further requires EPA to promulgate regulations within 15 months that:

“(A) minimize the disposal of containerized liquid hazardous waste in landfills, and (B) minimize the presence of free liquids in containerized hazardous waste to be disposed of in landfills. Such regulations shall also prohibit the disposal in landfills of liquids that have been absorbed in materials that biodegrade or that release liquids when compressed as might occur during routine landfill operations.”

The legislative history of these amendments reveals that Congress considered prohibiting entirely the placement of all liquids, containerized or not, in a landfill, but later reconsidered containerized liquids, particularly those designed to hold small quantities, such as ampoules or lab packs (U.S. EPA 1986a).

To comply with Section 3004(c)(1), an owner or operator must first use the Paint Filter Liquids Test (U.S. EPA 1986b) to determine whether a waste is a liquid or contains free liquids. If a sample passes the test, the waste is not subject to the ban. If it does not pass, the waste must be chemically, thermally, or biologically treated prior to landfilling by the application of a technology that does not involve the use of a material that functions primarily as a sorbent (including both absorbents and adsorbents). The EPA believes the purpose of this congressional ban on sorbents is to force the use of treatment technologies that are not reversible, such as chemical stabilization. An absorbent may release the absorbed liquid back into the landfill; chemical stabilization renders liquids permanently unavailable to the environment. The emphasis is on a permanent solution, not a temporary alternative (U.S. EPA 1986c).

The use of a sorbent as part of the chemical stabilization process can make it difficult to determine whether true stabilization has taken place. If there is any doubt, the EPA guidance document “Prohibition on the Disposal of Bulk Liquid Hazardous Waste in Landfills - Statutory Interpretive Guidance” recommends the use of an unconfined compressive strength test as an indirect method for determining the extent to which the waste has been chemically transformed into a solid state. The test should be modeled on ASTM D2166-85, Unconfined Strength of Cohesive Soil. This test is applicable to a wide range of stabilized wastes, regardless of the specific waste type or stabilization process used. A minimum strength of 50 psi is recommended as a measure of adequate bonding. The rationale for selecting this value is an attempt to require a bonding level in excess of that achieved with sorbents. A minimum compressive strength limit of 50 psi should assure that the treated waste has at least as much strength as the soil surrounding the disposal site. In general, the addition of large quantities of stabilization agents resulted in a more solid product with greater strength (U.S. EPA 1986c).

If an owner or operator wishes, it is acceptable to use a different method to prove that a chemical reaction has occurred. Several waste-specific or additive-specific tests are available; however, the data must prove conclusively that chemical stabilization/solidification, not absorption/adsorption, has taken place and that the hazardous constituents are in their least soluble, least toxic state (U.S. EPA 1986c).

Sections 3004(d), (e), and (g) of HSWA prohibit continued land disposal of untreated hazardous waste unless it can be proven there will be “no migration of hazardous constituents...as long as the wastes remain hazardous.” Section 3004(m) requires EPA to establish “...levels or methods of treatment, if any, which substantially diminish the toxicity of the waste or substantially reduce the likelihood of migration of hazardous constituents from the waste so that short-term and long-term threats to human health and the environment are minimized.”

The Congress set deadlines for developing standards for wastes containing solvents and dioxins, for wastes containing constituents known as the “California list” chemicals, and for all remaining hazardous wastes identified as of November 8, 1984. All the remaining hazardous wastes were ranked into three groups according to their intrinsic hazard and their volume. Based on that ranking, treatment standards are to be developed according to a schedule, with the standards for the highest ranking third being set first (U.S. EPA 1988a).

The key portion of this section of the 1984 HSWA is the mandate for treatment standards for every waste or group of similar wastes. Treatment standards are based on the performance of the best demonstrated available technology (BDAT) to treat the waste. A technology is considered best if its performance is statistically better than that of other technologies. A technology is considered to have been demonstrated for a particular waste if it is in full-scale commercial operation for treatment of that waste or a similar waste. An available technology is one that is commercially available or can be leased. Treatment standards can be established either as a specific technology or as a concentration level based on a BDAT technology. When treatment standards are fixed at a concentration level, the regulated community can use any technology not otherwise prohibited to treat a waste so that it meets the treatment standard. Dilution with aqueous or nonaqueous agents is prohibited either as a partial or as a complete substitute for adequate treatment of a restricted waste (U.S. EPA 1986d). Addition of materials as part of the treatment process, such as fixatives, is not prohibited, however. When treatment standards were first proposed on April 8, 1988, EPA indicated a preference for establishing concentration-based treat-

ment standards rather than treatment standards expressed as specific technologies because this provides greater flexibility in meeting the goal and encourages the development of more efficient and innovative technologies (U.S. EPA 1988a). Compliance is determined by measuring the concentration level of the hazardous constituents in the waste, the residual, or an extract of the waste or treatment residual. When treatment standards are expressed as specific technologies, however, those technologies must be used (U.S. EPA 1988b).

On August 17, 1988, EPA promulgated treatment standards for hazardous wastes listed in 40 CFR 268.10 (the first one-third of the schedule of restricted hazardous wastes). For three of these wastes, F006, K046, and K022 nonwastewaters, the BDAT performance standard is based on stabilization; four other wastes included in this regulation list stabilization as the BDAT for nonwastewater residuals (K001 and K086) or ash residue (K101 and K102) following the initial treatment. On January 11, 1989, EPA proposed treatment standards for hazardous wastes listed in 40 CFR 268.11 (the second one-third of the schedule of restricted hazardous wastes) (U.S. EPA 1989). The EPA also proposed treatment standards for some First Third wastes listed in 40 CFR 268.10 and Third Third wastes listed in 40 CFR 268.12. With regard to these wastes, proposed BDAT performance standards for one Second Third waste (F012) and two First Third wastes (F006 and F019) were based on stabilization. Treatment standards for F006 were previously promulgated in the August 17 regulations; however, at that time, standards for cyanide were reserved. In the January 11 proposal, EPA added proposed treatment standards for total and amenable cyanide in F006 nonwastewaters. Figure 2-1 shows the BDAT treatment standards for these waste codes as published in the Federal Register. In each case, research for the development of the performance standard indicated that full-scale stabilization is widely used throughout the country to bind these waste constituents into a cementitious matrix that immobilizes them, and thereby reduces their leaching potential.

2.3 The Comprehensive Environmental Response, Compensation, and Liability Act (CERCLA)

The Comprehensive Environmental Response, Compensation, and Liability Act (CERCLA) of 1980 was an important landmark in the legislative battle against hazardous waste. It was the first comprehensive Federal law to establish a mechanism of response for the immediate cleanup of hazardous waste contamination from an accidental spill or from chronic degradation (such as from an abandoned waste site). It also required that the National Contingency Plan (NCP) be revised to include a new subpart (known as the Na-

tional Hazardous Substance Response Plan) that would establish procedures and standards for responding to releases of hazardous substances, pollutants, and contaminants. Promulgated in mid-1982 and revised in late 1985, the Hazardous Substances Response subpart of the NCP first outlined the level of cleanup necessary at a Superfund site and allowed the Federal Government, or a cooperating State government, to "take any appropriate action to abate, minimize, stabilize, mitigate, or eliminate the release..." at any site that posed a potential threat to the public health or the environment (U.S. EPA 1985). Specific techniques mentioned in the NCP for remedial action at hazardous waste sites include solidification for treatment of contaminated soils and sediments.

On December 21, 1988, EPA issued proposed rules that, if promulgated, will revise the NCP. The proposed NCP revisions are intended to implement regulatory changes necessitated by the Superfund Amendments and Reauthorization Act (SARA) as well as to clarify existing NCP language and to reorganize the NCP to coincide more accurately with the sequence of response actions.

2.4 Superfund Amendments and Reauthorization Act (SARA)

The most recent legislation concerned with hazardous waste cleanup and disposal is Public Law 99-499, the Superfund Amendments and Reauthorization Act of 1986 (SARA). The benefits of SARA, which added a new dimension to CERCLA, are twofold: 1) it reaffirms Congress' commitment to take whatever action is necessary to stop further deterioration of the environment through the unwise removal and/or disposal of hazardous waste, and 2) it establishes a strong innovative technology program for the development of new onsite methods of treating hazardous waste.

Section 121 of SARA (Cleanup Standards) strongly recommends remedial actions involving onsite treatment that "... permanently and significantly reduces the volume, toxicity, or mobility of hazardous substances." The actions must assure the protection of human health and the environment, must be cost-effective, and to the extent practicable, also must be in accordance with the NCP. This means that the first step in the selection of an appropriate remedial action is to determine the level of cleanup necessary to protect the environment, and the second step is to choose the most cost-efficient means of achieving that goal. Section 121 further states that "off-site transport and disposal...without such treatment should be the least favored alternative remedial action where practical treatment technologies are available." This strongly encourages the use of the onsite treatment technologies recommended in the RCRA regulations. Once again, emphasis is on a permanent solution, not a temporary alternative.

Figure 2-1. BDAT treatment standards for waste codes based on stabilization.

**BDAT TREATMENT STANDARDS METAL FINISHING
SLUDGES SUBCATEGORY FOR F006
[Nonwastewaters]**

Constituent	Maximum for any single grab sample	
	Total composition (mg/kg)	TCLP (mg/l)
Cadmium	(1)	0.066
Chromium (total)	(1)	5.2
Lead	(1)	.51
Nickel	(1)	.32
Silver	(1)	.072
Cyanides (total)	110	(1)
Cyanides (amenable)	0.064	(1)

¹ Not applicable.

**BDAT TREATMENT STANDARDS FOR K001
[Nonwastewaters]**

Constituent	Maximum for any single grab sample	
	Total composition (mg/kg)	TCLP (mg/l)
Naphthalene	0.15	(1)
Pentachlorophenol	.88	(1)
Phenanthrene	.15	(1)
Pyrene	.14	(1)
Toluene	.14	(1)
Xylenes	.16	(1)
Lead	.037	(1)

¹ Not applicable.

**BDAT TREATMENT STANDARDS METAL FINISHING
SLUDGES SUBCATEGORY FOR F012 AND F019
[Nonwastewaters]**

Constituent	Maximum for any single grab sample	
	Total composition (mg/kg)	TCLP (mg/l)
Cyanides (total)	110	(1)
Cyanides (amenable)	0.064	(1)
Cadmium	(1)	0.066
Chromium	(1)	5.2
Lead	(1)	0.51
Nickel	(1)	0.32
Silver	(1)	0.072

¹ Not applicable.

**BDAT TREATMENT STANDARDS FOR K022
[Nonwastewaters]**

Constituent	Maximum for any single grab sample	
	Total composition (mg/kg)	TCLP (mg/l)
Acetophenone	19	(1)
Sum of diphenylamine and diphenylnitrosamine	13	(1)
Phenol	12	(1)
Toluene	.034	(1)
Chromium (total)	(1)	5.2
Nickel	(1)	.32

¹ Not applicable.

Figure 2-1. BDAT treatment standards for waste codes based on stabilization. (continued)

BDAT TREATMENT STANDARDS FOR K046
(Nonwastewaters)
[Nonreactive subcategory]

Constituent	Maximum for any single grab sample	
	Total composition (mg/kg)	TCLP (mg/l)
Lead	(1)	0.18

¹ Not applicable.

BDAT TREATMENT STANDARDS FOR K101
(Nonwastewaters)
[Low Arsenic Subcategory - less than 1% total arsenic]

Constituent	Maximum for any single grab sample	
	Total composition (mg/kg)	TCLP (mg/l)
Ortho-nitroaniline	14	(1)
Cadmium	(1)	0.066
Chromium (total)	(1)	5.2
Lead	(1)	.51
Nickel	(1)	.32

¹ Not applicable.

BDAT TREATMENT STANDARDS FOR K086
(Nonwastewaters)
[Solvent Washes Subcategory]

Constituent	Maximum for any single grab sample	
	Total composition (mg/kg)	TCLP (mg/l)
Acetone	0.37	(1)
bis(2-ethylhexyl) phthalate	.49	(1)
n-Butyl alcohol	.37	(1)
Cyclohexanone	.49	(1)
1,2-Dichlorobenzene	.49	(1)
Ethyl acetate	.37	(1)
Ethyl benzene	.031	(1)
Methanol	.37	(1)
Methylene chloride	.037	(1)
Methyl ethyl ketone	.37	(1)
Methyl isobutyl ketone	.37	(1)
Naphthalene	.49	(1)
Nitrobenzene	.49	(1)
Toluene	.031	(1)
1,1,1-Trichloroethane	.044	(1)
Trichloroethylene	.031	(1)
Xylenes	.015	(1)
Chromium (total)	(1)	0.094
Lead	(1)	.37

¹ Not applicable.

BDAT TREATMENT STANDARDS FOR K102
(Nonwastewaters)
[Low Arsenic Subcategory - less than 1% total arsenic]

Constituent	Maximum for any single grab sample	
	Total composition (mg/kg)	TCLP (mg/l)
Ortho-nitrophenol	13	(1)
Cadmium	(1)	0.066
Chromium (total)	(1)	5.2
Lead	(1)	.51
Nickel	(1)	.32

¹ Not applicable.

A new criterion that SARA added to CERCLA for use in determining cleanup priority concerns the contamination or potential contamination of the ambient air. Because stabilization/solidification often involves the treatment of organic constituents, this criterion is of primary concern in that the stabilization/solidification method selected must not release VOC's into the ambient air.

The second benefit from SARA—the requirement that EPA establish a coordinated research program aimed at developing alternate treatment technologies that will be applicable for onsite treatment—will prevent the potentially dangerous transport of wastes to other locations. The purpose of the Superfund Innovative Technology Evaluation (SITE) Program is to maximize the use of technologies other than land disposal for treating wastes found at unregulated hazardous waste sites. One way of accomplishing this is through the full-scale demonstration of favorable, innovative technologies that provide permanent cleanup solutions. The SITE program involves a collaborative arrangement with the private sector in which the EPA selects the

technologies, locations, and wastes; the developers set up and demonstrate their process or equipment on the site; and EPA evaluates how the system performs. This approach lends credibility to effective innovative technologies and speeds up the process of commercialization (Skinner and Bassin 1988).

The State of California also sponsors an innovative technology program. Many of the California SITE projects involve the demonstration of a stabilization/solidification process (McGraw-Hill 1988). Several other States have established the mechanisms for SITE programs and expect to begin operating them soon. These States will either work jointly with the EPA to help select sites for cofunded research projects or as independently operated studies. It is hoped that, through these programs, new methods of stabilization/solidification will be developed to take their place alongside the current commercial processes as one of the most efficient, permanent, and cost-effective methods of treating appropriate hazardous wastes.

Section 3

State of the Art Stabilization/Solidification Processes

This section provides a brief introduction to stabilization/solidification processes to promote a better understanding of these processes. Much of the stabilization/solidification that now occurs in the United States is based on the chemistry of lime or cement. Although not currently used on a widespread basis, some organic processes may have considerable use in the future or for specialized applications. The widespread use of organic processes for hazardous waste stabilization/solidification has been hampered by their high cost, their high energy consumption, or their specialized applications. They have been used in the nuclear industry, however, and may have application for certain hazardous wastes.

Other considerations that are important in an evaluation of a stabilization/solidification process include 1) pretreatment, i.e., whether the waste will benefit from an operation such as neutralization; 2) proprietary agent addition, i.e., whether the stabilized/solidified waste will benefit from the other agents; and 3) site considerations, i.e., what influence the site itself will have on treatment operations.

3.1 Process Overview of Stabilization/Solidification Technology

A brief overview of four stabilization/solidification technologies is presented in this section. These four technologies can be grouped as inorganic stabilization/solidification—cement-based and pozzolanic; and organic stabilization/solidification—thermoplastic and organic polymerization. Inorganic stabilization/solidification with cements and pozzolans has been used for hazardous waste more often than the other technologies. Organic stabilization/solidification with thermoplastic binders and organic polymerization has been applied to select hazardous wastes; however, this has taken place on a much smaller scale than stabilization/solidification with cements and pozzolans. Examples of the types of wastes that have been stabilized/solidified with these four binders are included at the end of each description.

3.1.1 Inorganic Stabilization/Solidification

3.1.1.1 Cement-Based Stabilization/Solidification

Cement-based stabilization/solidification is a process in which waste materials are mixed with portland cement. Water is added to the mixture, if it is not already present in the waste material, to ensure the proper hydration reactions necessary for bonding the cement. The wastes are incorporated into the cement matrix and, in some cases, undergo physical-chemical changes that further reduce their mobility in the waste-cement matrix. Typically, hydroxides of metals are formed, which are much less soluble than other ionic species of the metals. Small amounts of fly ash, sodium silicate, bentonite, or proprietary additives are often added to the cement to enhance processing. The final product may vary from a granular, soil-like material to a cohesive solid, depending on the amount of reagent added and the types and amounts of wastes stabilized/solidified.

Cement-based stabilization/solidification has been applied to plating wastes containing various metals such as cadmium, chromium, copper, lead, nickel, and zinc. Cement has also been used with complex wastes containing PCBs, oils, and oil sludges; wastes containing vinyl chloride and ethylene dichloride; resins; stabilized/solidified plastics; asbestos; sulfides; and other materials (Jones 1986; Tittlebaum and Seals 1985). Studies performed under the BDAT program on contaminated soil showed cement-based stabilization/solidification effective for arsenic, lead, zinc, copper, cadmium, and nickel (Weitzman 1988). Effectiveness of this process on organics is not known.

3.1.1.2 Pozzolanic Stabilization/Solidification

Pozzolanic stabilization/solidification involves siliceous and aluminosilicate materials, which do not display cementing action alone, but form cementitious substances when combined with lime or cement and water at ambient temperatures. The primary containment

mechanism is the physical entrapment of the contaminant in the pozzolan matrix. Examples of common pozzolans are fly ash, pumice, lime kiln dusts, and blast furnace slag. Pozzolans contain significant amounts of silicates, which distinguish them from the lime-based materials. The final product can vary from a soft fine-grained material to a hard cohesive material similar in appearance to cement. Pozzolan reactions are generally much slower than cement reactions. Waste materials that have been stabilized/solidified with pozzolans include oil sludges, plating sludges containing various metals (aluminum, nickel, copper, lead, chromium, and arsenic), waste acids, and creosote.

3.1.2 Organic Stabilization/Solidification

3.1.2.1 Thermoplastic Stabilization/Solidification

Thermoplastic stabilization/solidification is a microencapsulation process in which the waste materials do not react chemically with the encapsulating material. In this technology, a thermoplastic material, such as asphalt (bitumen) or polyethylene, is used to bind the waste constituents into a stabilized/solidified mass. The asphalt binder may be heated before it is mixed with a dry waste material, or the asphalt may be applied as a cold mix. In the latter case, compaction is used to remove additional water from the surrounding aggregate/waste particles. Bitumen may have commercial application for stabilizing/solidifying oil- and gasoline-contaminated soils. In this application, the hydrocarbon-contaminated soil is used to dilute the bitumen, which is then used as paving or patching material for roads. The resulting consistency will vary depending on the density of the hydrocarbon mixed into the bitumen and the amount of aggregate added to the mixture. Thermoplastic encapsulation can also be applied to electroplating sludges, painting and refinery sludges containing metals and organics, dry incinerator ash, fabric filter dust, and radioactive wastes (Tittlebaum et al. 1985).

3.1.2.2 Macroencapsulation

Macroencapsulation is a process that places the waste in an overpack drum. The waste is generally stabilized/solidified and (sometimes) microencapsulated prior to drumming. At one time it was believed that liquids could be stored in these drums because of their excellent integrity and shock resistance. The banning of liquids from landfills has effectively eliminated this option. Most macroencapsulated work stems from that originally conducted by Lubowitz and Wiles (1979) and fully developed by Environmental Protection Polymers (Unger et al., undated). A second macroencapsulated process was developed by Bondico, Inc. (Shaw 1987).

Typical wastes that Environmental Protection Polymers believe to be appropriate for macroencapsulation include low-level nuclear waste, electroplating sludge, and coal scrubber sludge (Unger et al.). Other appro-

prate candidates are highly concentrated or toxic materials such as incinerator ash, PCBs, and dioxins. The Environmental Protection Polymers process chemically stabilizes/solidifies a sludge with lime or cement. This material is then agglomerated by a polybutadiene binder (actually representing microencapsulation). Environmental Protection Polymers chose polybutadiene for agglomeration because of its high tolerance for a variety of pollutants and because it yields tough products. The polybutadiene agglomerates the waste by a thermosetting reaction in a polymerization process at temperatures of 120° to 200°C.

After the agglomeration step, the waste matrix is encapsulated. Encapsulation has been accomplished with polyethylene resin. Environmental Protection Polymers has actually molded this material onto some of its agglomerated products. Much effort has also been devoted to the development of a spin-welding process, which consists of four basic steps:

- 1) Polyethylene overpack drums are filled with agglomerated waste and then transferred to the loading area of the welding unit.
- 2) The operator activates the drum-positioning mechanism to position the drum for welding.
- 3) The lid is welded to the rotating drum.
- 4) The operator unclamps the drum and removes the encapsulated material.

Bondico, Inc., also developed a macroencapsulation system in which an electrical current fused the polyethylene lid and container together (Shaw 1987).

When considered on its technical merits alone, macroencapsulation appears to be an attractive stabilization/solidification technology. It has not been widely used, however, and is apparently unavailable for immediate use because Bondico is no longer in business. Some specialized applications may warrant the use of such a technology, and it is well documented.

3.1.2.3 Organic Polymerization Stabilization/Solidification

Organic polymerization stabilization/solidification relies on polymer formation to immobilize the constituents of concern. Urea formaldehyde is the most commonly used organic polymer for this purpose. Organic polymerization has been used primarily to stabilize/solidify radioactive wastes. This technology has been applied on a limited basis to hazardous wastes such as organic chlorides, phenols, paint sludges, cyanides, and arsenic. Polymerization can also be applied to flue gas desulfurization sludge, electroplating sludges, nickel/cadmium battery wastes, kepone-contaminated sludge, and chlorine product wastes that have been dewatered and dried (Kyles, Malinowski, and Staczyk 1987).

3.1.2.4 Organophilic Clay- Based Stabilization/Solidification Processes

This technology appears to be very promising in terms of binding organic wastes. Recent investigations (Gibbons and Soundararajan 1988) indicate that these organophilic binders truly bond with organic wastes, and when forced out, these waste molecules break down into smaller fragments. Further, this process appears to be cost-effective compared with incineration. Because this technology also uses cementitious materials, it can handle both organic and inorganic wastes.

3.2 Stabilization/Solidification Activity in the Various U.S. Environmental Protection Agency Regions

Table 3-1 lists sites where hazardous waste stabilization/solidification has been used, is in use, or is pro-

posed to remediate hazardous wastes. This table presents pertinent information on each case study, including the site name, the company involved in treating the wastes, the types and concentrations of the contaminants encountered, the amount of material processed, the type of processing used, the disposal location, and whether the study is full-scale, pilot-scale, or bench-scale. Cement was used in the majority of the case studies presented, and pozzolanic materials were used in some.

Table 3-1. Solidification case studies.

Site/ contractor	Contaminant (concentration)	Treatment volume	Physical form	Chemical pretreat- ment Y/N	Binder	Percentage binder(s) added	Treatment (batch/ continuous in situ)	Disposal (onsite/ offsite)	Volume increase, %	Scale of operation
Independent, Nail, SC, Region IV	Zn, Cr, Cd, Ni	6,600 yd ³	Solid/soils	N	Portland cement	20%	Batch plant	Onsite	>Small	Full scale (de- listing in progress)
Midwest, U.S. Plating Company, Enwite	Cu, Cr, Ni	16,000 yd ³	Sludge	N	Portland cement	20%	In situ	Onsite	>0	Full scale
Unnamed, ENRECO	Pb/soil 2-100 ppm	7,000 yrd ³	Solid/soils	N	Portland cement and proprietary	Cement (15-20%) proprietary (5%)	In situ	Landfill	Mass >20% (volume >30-35%)	Full scale
Marathon Steel, Phoenix, AZ Silicat, Tech.	Pb, Cd	150,000 yd ³	Dry - landfill	N	Portland cement and silicates (Toxsorb) TM	Varied 7-15% (cement)	Concrete batch plant	Landfill	NA	Full scale
Alaska Refinery HAZCON	Oil/oil sludges	2,300 yd ³	Sludges, variable	Y	Portland cement and proprietary	Varied 50+	Concrete batch plant	Onsite	>35%	Full scale
Unnamed, Kentucky, ENRECO	Vinyl chloride Ethylene dichloride	180,000 yd ³	Sludges, variable	Y	Portland cement and proprietary	Varied 25 +	In situ	Onsite (2 secure cells built on site)	>7-9%	Full scale
N.E. Refinery ENRECO	Oil sludges, Pb, Cr, As	100,000 yd ³	Sludges, variable	N	Kiln dust (high CaO content)	Varied, 15-30%	In situ	Onsite	>Varied, ~20% average	Full scale
Velsicol Chemical Memphis Env. Centre	Pesticides and organics (resins, etc.) up to 45% organic	20,000,000 gallons	Sludges, variable	N	Portland cement and kiln dust, proprietary	Varied (cement 5-15%)	In situ	Onsite	>Varied ~10% or less	Full scale
Amoco Wood River Chemfix	Oil/solids Cd, Cr, Pb	90,000,000 gallons	Sludges	Y	Chemfix proprietary	NA, proprietary	Continuous flow (pro- prietary process)	Onsite	Average 15%	Full scale (site delisted 1985)

(continued)

Table 3-1. (continued)

Site/ contractor	Contaminant (concentration)	Treatment volume	Physical form	Chemical pretreat- ment Y/N	Binder	Percentage binder(s) added	Treatment (batch/ continuous in situ)	Disposal (onsite/ offsite)	Volume increase, %	Scale of operation
Pepper Steel & Alloy, Miami, FL VFL Technology Corporation	Oil sat. soil Pb - 1000 ppm PCBs - 200 ppm As - 1-200 ppm	62,000 yd ³ (plus 5000 tons of surface debris)	Soils	Y	Pozzolanic and proprietary	~30%	Continuous feed (mixer proprietary design)	Onsite	~1%	Full scale
Vickery, Ohio Chemical Waste Management	Waste acid PCBs (<500 ppm), dioxins	~235,000 yd ³	Sludges (viscous)	Y	Lime and kiln dust	~15% CaO ~5% kiln dust	In situ	Onsite (TSCA cells)	>~9%+	Full scale
Wood Treating, Savannah, GA Geo-Con, Inc.	Cresosote wastes	12,000 yd ³	Sludges	Y	Kiln dust	20%	In situ	Onsite lined cells	>~14%	Full scale
Wyandotte, MI Treatment Plant Chem Met	Various/combined	20 million gal/yr	Various	N	Lime		Continuous	Offsite (secure landfill)		In-plant process
Chem Refinery, TX HAZCON	Combined metals, sulfur, oil sludges, etc.	90,000 gal. (445 yd ³)	Sludges (synthetic oil sludges)	N	Portland cement and proprietary	NA	Continuous flow	Onsite (secure landfill)	>Estimated 10%	Full scale
Chicago Waste Hauling, American Colloid	Metals: Cr, Pb, Ba, Hg, Ag	55 gallon/ batch (bench study)	Various		Proprietary	10-40%	Batch mix (pug mill)	NA	>Variable	Bench scale
API sep. sludge, Puerto Rico, HAZCON	API separator sludges	100 yd ³	Sludges	N	Portland cement and proprietary	50% cement ~4% pro- prietary	Concrete batch plant	Offsite secure landfill)	>~4-5%	Full scale
Metallizing, WI, Geo-Con, Inc.	Al - 9500 ppm Ni - 750 ppm Cr - 220 ppm Cu - 2000 ppm	3000 yd ³	Sludges	N	Lime	10-25%	In situ	Onsite landfill)	>~4-10%	Full scale
James River Site Virginia	Keopene contaminated sediments		Wet soil sludges	N	Cement-base, thermoplastic, polymer	Various	Various		NA	Bench scale only

(continued)

Table 3-1. (continued)

Site/ contractor	Contaminant (concentration)	Treatment volume	Physical form	Chemical pretreat- ment Y/N	Binder	Percentage binder(s) added	Treatment (batch/ continuous in situ)	Disposal (onsite/ offsite)	Volume increase, %	Scale of operation
Massachusetts, American Reclamation Corporation	Oil/gasoline contaminated soils	Variable	Wet soil	Y	Bitumen	Variable	Batch	Used as road patch/ paving mate- rials	NA	Bench (pilot in process)
Saco Tannery Waste Pits, Maine/VFL Tech. Corporation	Cr (>50,000 ppm) Pb (>1000 ppm) and organics	Varied	Sludge		Fly ash, quicklime	30% fly ash 10% quick lime	In-situ	Onsite	>15%	Pilot scale
Sand Springs Petro- chemical, Complex, OK/Arco	Sulfuric acid, and organics		Sludge		Fly ash, quicklime	Varied	Batch	Onsite		
John's Sludge Pit, KS/Terracon Consultants, Inc.	Pb, Cr, acid		Sludge		Cement kiln dust and fly ash	Varied	Batch		>Variable	Bench scale
Gold Coast, FL	VOC's and metals	1500 ^a yd ³	Soil					Onsite		
Gurley Pit, AR	PCB's and organics	432,470 ^a yd ³	Soil					Onsite		
Liquid Disposal Landfill, MI	PCB's, VOC's, heavy metals		Soil					Onsite		
Northern Engraving, WI	VOC's, organic, and inorganics	4400 ^a yd ³	Sludge					Onsite		
Mid South, AR	PAH's, organics, and inorganics	45,750 ^a yd ³	Soil					Onsite		
Hialeah, FL Geo-Con, Inc.	PCB's 0.800 ppm	300 yd ³ (7,000 yd ³ total)	Wet soil	N	HWT-20™ (cement based)	15%	In situ	Onsite	>Small	Pilot scale

(continued)

Table 3-1. (continued)

Site/ contractor	Contaminant (concentration)	Treatment volume	Physical form	Chemical pretreat- ment Y/N	Binder	Percentage binder(s) added	Treatment (batch/ continuous in situ)	Disposal (onsite/ offsite)	Volume increase, %	Scale of operation
Douglasville, PA HAZCON	Zn, 30-50 ppb Pb, 24,000 ppm PCB's, 50-80 ppm Phenol, 100 µg/liter Oil and grease	250,000 yd ^{3a}	Various soil/ sludges	N	Portland cement and proprietary	NA	Batch	NA	NA	Pilot scale
Portable Equipment, Clackamas, OR CHEMFIX	Pb, Cu, PCB's	40 yd ³	Soil	N	Cement, silicate	NA	Batch	NA	NA	Pilot scale
Imperial Oil Morganville, NJ Solidtech	PCB's	50 yd ³	Soil	N	Cement, proprietary	NA	Batch	NA	NA	Pilot scale

NA - Data not available
^a Total volume onsite.

Section 4

Physical Tests To Characterize Wastes Before and After Stabilization/Solidification

Physical testing is conducted to characterize and contrast waste before and after stabilization/solidification. It provides basic information on the treatability of the waste material and allows some estimate to be made of the cost of waste treatment and handling. Physical property characterization of unstabilized/unsolidified wastes focuses on treatability, excavation, transport, storage, and mixing considerations (Cullinane et al. 1986). Physical testing of stabilized/solidified wastes helps to demonstrate the relative success or failure of a stabilization/solidification process. The physical testing methods described in this section may be applicable to both untreated hazardous wastes and stabilized/solidified hazardous wastes; however, the tests were not developed for use on these wastes.

This section describes the more common physical tests used to evaluate waste stabilization/solidification processes. The physical tests listed in Table 4-1 include:

- Index Property Tests, which provide data that are used to relate general physical characteristics of a material (e.g., suspended solids) to process operational parameters (e.g., pumpability).
- Density Tests, which are used to determine weight to volume relationships of materials.
- Permeability Tests, which measure the relative ease with which fluids (water) will pass through a material.
- Strength Tests, which provide a means for judging the effectiveness of a stabilization/solidification process under mechanical stresses.
- Durability Tests, which determine how well a material withstands repeated wetting and drying or freezing and thawing cycles.

Individual values of waste properties derived from specific tests are used along with other available data to make informed engineering decisions. In several cases, the tests provide data useful only for comparing different stabilization/solidification methods.

It is important to note that many of these tests were originally developed for testing soils and cement-like materials for stability for construction projects. Ex-

treme caution must be exercised when applying these tests to untreated and stabilized/solidified hazardous wastes, and in the subsequent data interpretation. Many of the tests involve frequent handling of the waste materials; therefore, due consideration must be given to personnel protection, sample handling and disposal requirements, and other factors associated with the presence of hazardous constituents in the samples.

4.1 Index Property Testing

Index property tests provide data that are used to relate general physical characteristics of a material to process operational parameters. These tests are most frequently performed on the unstabilized/unsolidified waste to determine the feasibility of various stabilization/solidification technologies. Stabilization/solidification process vendors have indicated that particle size distribution, pH, and moisture content are critical factors in choosing a stabilization/solidification process (Wiles 1987).

4.1.1 Particle Size Analysis (ASTM D422-63)

Particle Size Analysis is a quantitative determination of a material's particle size distribution and is broadly used in engineering classification of materials. The test provides data pertaining to material characteristics, such as:

- Relative proportions of gravel, sand, silts, and clay-sized particles (i.e. "texture")
- Uniformity, concavity, and average grain size
- Maximum and minimum size of particles

The grain size distribution of a material can also be qualitatively used to predict a fairly wide range of characteristics, including soil-water movement (i.e., permeability) and compressibility.

This analysis is usually performed prior to stabilization/solidification to suggest the feasibility of a particular process or the difficulties that could be encountered in processing.

4.1.1.1 Test Description

Grain-size analyses can be completed by sieve analysis or by hydrometer analysis. The sieve analysis is

Table 4-1. Physical testing methods.

Test procedure	Reference ^a	Purpose
Index property tests		
Particle size analysis	ASTM D422-63	To determine the particle size distribution of a material
Atterberg limits Liquid limit Plastic limit Plasticity index	ASTM D4318-84 ASTM D4318-84 ASTM D4318-84	To define the physical characteristics of a material as a function of its water content
Moisture content	ASTM D2216-80	To determine the percentage of free water in a material
Suspended solids	USEPA Method 208 C	To determine the amount of solids that do not settle from a column of liquids
Paint filter test	USEPA Method 9095-SW846	To determine the presence of free liquids in a representative sample of bulk or noncontainerized waste
Density testing		
Bulk density - drive cylinder method	ASTM D2937-83	To determine the in-place density of soils or soil-like material
Bulk density - sand-cone method	ASTM D1556-82	To determine the in-place density of soils or soil-like materials
Bulk density - nuclear methods	ASTM D2922-81	To determine the in-place density of soils or soil-like materials
Bulk density - stabilized waste		To determine the density of a monolithic stabilized waste
Compaction testing		
Moisture density relations of soil-cement mixtures	ASTM D558-82 ASTM 31557	To determine the relation between moisture content and density of a material
Permeability testing		
Falling head permeability	USEPA Method 9100-SW846	To measure the rate at which water will pass through a soil-like material
Constant head	USEPA Method 9100-SW846	To measure the rate at which water will pass through a soil-like material

(continued)

Table 4-1. (continued)

Test procedure	Reference ^a	Purpose
Strength testing	ASTM D 2166-85	To evaluate how cohesive soil-like materials behave under mechanical stress
Unconfined compressive strength of cohesive soils	ASTM D1633-84	To evaluate how cement-like materials behave under mechanical stress
Unconfined compressive strength of cylindrical concrete specimens	ASTM C109-86	To measure the compressive strength of hydraulic cement mortars
Compressive strength of hydraulic cement mortars	ASTM D1635-87	To evaluate a material's ability to withstand loads over a large area
Flexural strength	ASTM D3441-79	To evaluate a material's stability and bearing capacity
Cone index	ASTM D4842	To determine how materials behave or degrade after repeated freeze-thaw cycles
Durability testing	ASTM D4843	To determine how materials behave or degrade after repeated wet-dry cycles
Freeze-thaw durability		
Wet-dry durability		

^a ASTM - American Society for Testing and Materials.
Blank indicates no ASTM method or other reference method.

typically used to define the distribution of materials ranging from fine sand to gravel sizes (0.1 mm and larger). The hydrometer analysis is typically used to define the distribution of materials ranging from fine sand and silt to clay (0.1 mm and smaller).

The results of both of these tests are required for a complete evaluation of the distribution of particle sizes of soils containing both coarse- and fine-grained fractions. For materials containing less than 20 percent fines, the hydrometer analysis is often disregarded.

Evaluation of the particle size distribution of a material by sieve analysis is performed by first washing a dried and weighed sample through a No. 200 (0.075 mm) sieve to determine the percentage of fine-grained particles, and then redrying the sample and passing it through a series of circular screens with various mesh sizes. The sieving is usually done on a Ro-tap shaker, but sometimes by hand. The machine produces uniform circular and tapping motions that cause the particles to be sorted through the sieves. The apparatus can use as many as 13 screens at a time for maximum grain size differentiation. After sieving, the weight of the material on each screen is measured and is calculated as a percentage of the total. The results are plotted on a grading curve, as shown in Figure 4-1.

The use of this test is straightforward because the procedures are mechanical. Errors that do occur often relate to improper sampling of the material. These errors can be overcome by proper sampling techniques, such as quartering, or by using several samples and comparing their particle size distribu-

tions. Analysis may be difficult or unreliable when soil grains are contaminated with oils or other organic materials that have a tendency to agglomerate.

The hydrometer test is used to obtain an estimate of the distribution of particle sizes from the No. 200 sieve size (0.075 mm) to around 0.001 mm. This encompasses silt and clay-sized particles. According to Stoke's Law, which considers the terminal velocity of a single sphere falling in an infinity of liquid, the sizes calculated represent the diameter of spheres that would fall at the same rate as the soil particles (Note 14, ASTM D422-63).

In this test, a sample of approximately 50 grams of air-dried soil in 125 ml sodium hexametaphosphate ("Calgon ") solution (40 g/liter) is dispersed to neutralize soil-particle charges. After it soaks in the dispersing solution, the sample is further dispersed by mixing it in a mechanical or air-jet mixing apparatus. The dispersed mix is then transferred to a sedimentation cylinder, and distilled water is added to a total volume of 1000 ml. The mixture is again agitated briefly, and a hydrometer is placed in the cylinder to monitor changes in specific gravity of the solution over time. The measured values of specific gravity of the solution and known (or assumed) specific weights of the solid and fluid phases are used to calculate the grain sizes still in suspension as larger sizes fall out of suspension. Although the specific weight of water is typically used for calculations, contaminants desorbed from the solids may affect this value to some degree.

Figure 4-1. Typical particle-size grading curve.

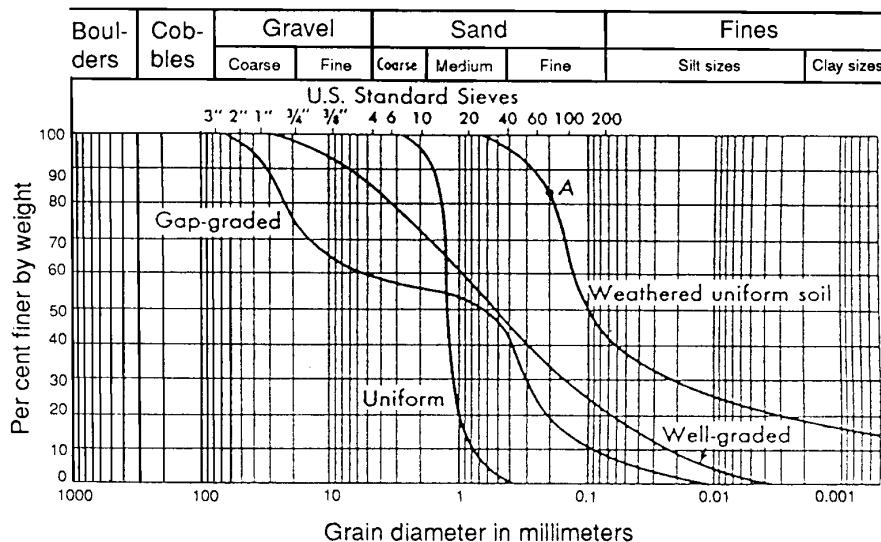

Source: Introductory Soil Mechanics and Foundations, by G. B. Sowers and G. F. Sowers. MacMillan Publishing Co., New York. 1970.

4.1.1.2 Interpretation and Application of Results

The shape of the gradation curve represents the particle size uniformity of the sample. A steep curve indicates a soil in which nearly all the grains are the same size. A flatter curve shows a wider variation in grain size and thus a well-graded soil. Figure 4-2 gives representations of well-graded (poorly sorted) and poorly graded (well-sorted) materials.

The absolute size and shape of the waste particles affect the feasibility of various stabilization/solidification processes and the ultimate strength of the stabilized/solidified product (Wiles 1987). Very fine or very coarse particles can increase the difficulty of stabilizing/solidifying wastes. For example, fine-grained wastes have been shown to produce poor stabilized/solidified materials because they lack the size needed to form a stabilized/solidified product with adequate durability (Cullinane et al. 1986). Vick et al. (1987), however, have shown that very hydrophobic contaminants such as dioxin tend to bind preferentially to small soil particles. Very large particles may also preclude the use of certain processing equipment or require particle size reduction prior to stabilization/solidification.

A well-graded soil that does not contain extremely large or extremely small particles is likely to show favorable physical characteristics after stabilization/solidification. The strong matrix formed by the interlocking of diversely sized particles often produces characteristics such as high strength, low permeability, and low leachability.

Figure 4-2. Illustration of material gradation.

MATERIAL GRADATION

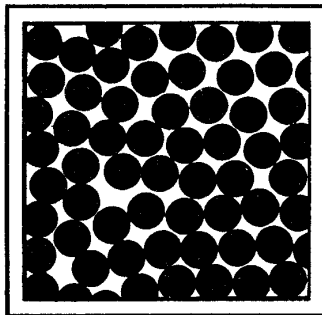

Poorly graded

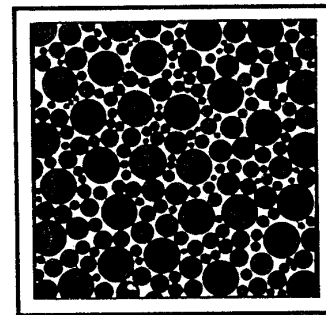

Well-graded

Source: Adapted from Caterpillar Performance Handbook, Caterpillar, Inc., Peoria, IL. October 1987.

4.1.2 Atterberg Limits (ASTM D4318-84)

The Atterberg Limits are a simple and useful series of tests originally developed for classification and characterization of clays used in ceramics.

Atterberg Limits are the moisture contents that mark a material's liquid and plastic states. The liquid limit of a material is the moisture content at which it will flow as a viscous liquid. The plastic limit is the moisture content at the boundary between the plastic and brittle states. The plasticity index is the difference between the liquid limit and plastic limit. Atterberg Limit tests are applicable to fine-grained materials only, and their results are useful not only for classification, but also for correlation with a broad range of engineering properties and to indicate clay mineralogy.

Atterberg Limits are used to estimate such properties as compressibility, strength, and swelling characteristics, and to indicate how the material will behave when stresses are applied (Cullinane 1986). In addition, the plasticity index can be used to determine the proper amount of stabilization/solidification agent (e.g., lime) to be added to a waste. Atterberg Limit tests are applicable to any natural or artificial mixture of soil-like particles.

The tests are performed on both unstabilized/unsolidified and freshly stabilized/solidified soil-like wastes. The resulting data can be particularly useful during the compacting of friable materials after stabilization/solidification. To date, these tests have not been completed extensively on hazardous waste materials; however, they are expected to be used more frequently in the future.

4.1.2.1 Definitions

The liquid limit is the moisture content of a soil at the arbitrarily defined boundary between the liquid and plastic states. The liquid limit can be regarded as the water content at which soil no longer acts as a plastic, but begins to act as a liquid (i.e., flows).

The plastic limit is the moisture content of a soil at the boundary between the plastic and brittle states. The plastic limit is considered the water content at which a soil no longer acts brittle, but can be molded and deformed without falling apart.

The plasticity index is the difference between the liquid limit and the plastic limit. Reduction in the plasticity index is used to judge the effect of lime addition to clays.

4.1.2.2 Test Description

Liquid Limit Determination—The material is mixed with water, placed in a brass cup, and divided in two with a grooving tool. The liquid limit is the water content at which the divided sample flows together after the cup is dropped by an apparatus 25 times from a height of 10 centimeters. The water content of the material is determined by the method described in Subsection 4.1.3.

Plastic Limit Determination—A sample is alternately pressed and rolled into a 1/8-inch-diameter thread. The sample slowly dries out until the thread can no longer be pressed together or rerolled; that water content is the plastic limit.

Although procedurally defined, the definitions of the liquid and plastic limits are at least partially subjective. For good consistency, the same tester should run duplicate trials of identical samples.

4.1.2.3 Interpretation and Significance of the Test

The test is part of several engineering classification systems to characterize fine-grained fractions of a material. These test results characterize material-handling properties and the variation in the properties as a function of water content. Liquid limit and plastic limit are used individually or together with other soil properties to correlate with other engineering behaviors such as compressibility, permeability, compactibility, shrinking/swelling, and shear strength.

Liquid limits for various waste/stabilization/solidification agent mixtures typically range between 40 and 55 percent water content. Typical plastic limits for various waste/stabilization/solidification agent mixtures are between 20 and 50 percent water content (Morgan et al. 1984).

4.1.3 Moisture Content (ASTM D2216-80)

The moisture content test determines the amount of free water (or fluid) in a given amount of material. This test is often used to determine if pretreatment is necessary in the design of the stabilization/solidification process (Cullinane 1986). An example of waste pretreatment would be sludge drying, dewatering, or consolidation prior to stabilization/solidification. Moisture in a waste is not always detrimental. For example, the presence of water may be needed to provide a reaction mechanism (e.g., hydration) for correct stabilization of the waste.

In this test method, the term “water” refers to “free” or “pore” water, not waters of hydration. Also, water in discontinuous pores is not measured by this test.

It is also important to note that water is often not the only liquid-phase constituent in contaminated materials. The fluids may also include a broad range of liquid wastes present in solution or as nonaqueous phase liquids. This can have several effects on the performance and results of moisture content determinations. For example, if VOCs are present, samples should be aerated to allow volatilization of flammable VOCs before samples are oven-dried. The type and level of contamination may also influence the relationship between “free” and adsorbed water.

4.1.3.1 Test Description

A preweighed sample is dried in an oven for 24 hours at a constant temperature of 110°C or at a temperature below the dehydration temperature. The sample is allowed to cool to room temperature in a desiccator. The difference between the original sample weight and the weight after drying is used to determine the moisture content.

During the collection of samples for analysis, the moisture content (free water) must not change during handling. Samples must be placed in appropriate jars and sealed with plastic, foil, or wax. Maintenance of a constant temperature in the drying oven is also important for achieving accurate results. A 5°C range is allowable.

Moisture content results for soils high in organic matter require careful interpretation. Organic material, including VOCs, may be driven off during the drying process. Any weight loss due to the organic matter will be recorded as water loss.

This method does not give truly representative results for materials containing significant amounts of halloysite, montmorillonite, and gypsum; highly organic soils; or materials with pore waters containing dis-

solved solids. For these soils, vacuum drying at 60°C may be better. Another source of error in moisture content determination of stabilized materials is the accelerated hydration reactions that may occur at the elevated temperatures used during the test. These reductions reduce the amount of free water available for evaporation and cause erroneous weight measurements.*

4.1.3.2 Interpretation and Application of Results

The results of this test are usually expressed as fluid representing a percentage of total mass (Cullinane 1986). This basic information is required for the planning and execution of a stabilization/solidification project. Excess moisture may have to be removed by filtration. Low moisture content may indicate the need to add water to stabilize the waste correctly. For example, water is sometimes added to incinerator ash to stabilize/solidify the ash.**

In a study by Stegemann et al. (1988) of 69 wastes, water content in the untreated wastes ranged from close to 100 percent for wastewaters to less than 10 percent for soils. After waste stabilization/solidification, water content ranged from 64 percent to less than 1 percent. In this study, the water content was determined from weighing a ground sample before and after drying to a constant weight at 60°C.

4.1.4 Suspended Solids (USEPA Method 208C)

"Suspended solids" is a term originally used in the monitoring of the quality of wastewater (both the influent and effluent of a wastewater treatment plant) and, by inference, the performance of the plant. "Total solids" include all solids, suspended and dissolved, present in a sample. Suspended solids are those removed by filtration. The difference between total solids and suspended solids is known as the "dissolved solids." One must know the suspended solids content of supernatants in lagoons or other impoundments to plan dewatering operations.

4.1.4.1 Test Description

A well-mixed sample is filtered through a preweighed standard glass-fiber filter (Gelman Type A or equivalent). The filter is then dried to a constant weight at 103° to 105°C, cooled in a desiccator, and reweighed. Suspended solids, expressed as a percentage, is the increased weight of the filter for a known volume of sample.

4.1.4.2 Interpretation and Applicability

Suspended solids content is an important parameter for determining the materials handling requirements

for a waste material, i.e., to determine if the waste can be pumped. Suspended solids content also can be used to estimate the decrease in volume that can be achieved by dewatering. Table 4-2 presents consistency categories for various waste types based on approximate suspended solids content. Although these categories are approximate, they give an indication of how a waste can be handled and the operations that can occur in and on the material.

Table 4-2. Liquid waste consistency classification.

Consistency category	Characteristic properties
Liquid waste	Less than 1% suspended solids,* pumpable liquid, generally too dilute for sludge dewatering operations.
Pumpable waste	Less than 10% suspended solids,* pumpable liquid, generally suitable for sludge dewatering.
Flowable waste	Greater than 10% suspended solids,* not pumpable, will flow or release free liquid, will not support heavy equipment, will undergo extensive primary consolidation.
Nonflowable waste	Solid characteristics, will not flow or release free liquids, will support heavy equipment, may be 100% saturated, may undergo primary and secondary consolidation.

*Suspended solid ranges are approximate. Source: Cullinane 1986.

4.1.5 Paint Filter Test (USEPA Method 9095-SW846)

The Paint Filter Test is used to determine the presence of "free liquids" in a representative sample of bulk (or noncontainerized) waste. The test is required by RCRA's 40 CFR 264.314 and 265.314 and is used to determine if a material releases free liquids.

The American Nuclear Society has a test similar to the Paint Filter Test, the Allowable Drainable Liquid Test (ANS 55.4). The EPA's Office of Solid Waste and Emergency Response is proposing that the Liquid Release Test be used in conjunction with the Paint Filter Test. In the December 24, 1986, Federal Register, the EPA proposed the use of the Liquid Release Test to test for release of liquids from nonbiodegradable absorbent mixtures when a waste is under compressive forces in a landfill. The proposed Liquid Release Test calls for the application of 50 psi pressure to the waste sample to determine if liquids will be released under compressive forces.

* Personal communication from Dr. Paul L. Bishop, University of Cincinnati, to M. Arozarena, PEI, September 30, 1988.

** Personal communication from M. John Cullinane, P.E., U.S. Army Corps of Engineers, Waterways Experimental Station, to T. Whipple, Earth Technology Corporation.

4.1.5.1 Test Description

In the Paint Filter Test, the material is placed in a paint filter, which rests in a funnel attached to a ring stand. If any portion of the material passes through and drops from the filter within the 5-minute test period, the material is deemed to contain free liquids.

4.1.5.2 Interpretation and Application of Results

As of May 8, 1985, the placement of bulk (or noncontainerized) liquid hazardous waste or hazardous waste containing free liquids in any landfill was prohibited [Land Ban HSWA Section 3004(c)(1)]. Absorbents (in contrast to stabilization/solidification agents) cannot be added to liquid wastes to achieve a temporary liquid-free status. In addition, no credit is given for the liner or leachate collection system that the landfill uses.

The Paint Filter Test may be performed after a waste is stabilized to determine whether the waste may be disposed of in a RCRA-authorized landfill. If it does not pass the Paint Filter Test, it must undergo further treatment before it can be disposed of in a landfill. (For further information on the Land Ban regulations, see Section 2.)

4.2 Density Testing

Bulk density is the ratio of the total weight (solids and water) to the total volume. Bulk density, along with specific gravity and moisture content measurements, can be used to calculate a material's porosity. More commonly, bulk density values are used to convert weight to volume for materials-handling calculations and are essential for characterizing the rates at which a soil can be excavated. In addition, bulk density data provide a comparison between stabilized and unstabilized waste. Calculated increases in volume of a material due to changes in bulk density after excavation may determine if the stabilized materials can be disposed of on site or must be shipped offsite.

Four methods of bulk density measurement are presented. The data from each are sufficiently accurate for calculating densities. Selection of a method is usually based on ease of use. Laboratory determination of specific gravity can supplement these measurements.

4.2.1 Bulk Density—Drive-Cylinder Method (ASTM D2937-83)

The Drive-Cylinder Method is designed to determine the in-place density and moisture content of soils or soil-like wastes. Because the test is not appropriate for nondeformable materials, it is limited to unstabilized, freshly stabilized, or soil-like stabilized waste that have been compacted by conventional earth-moving equipment.

A thin-walled cylinder is driven into the soil to obtain a sample. The weight per unit of volume of the sample in the cylinder is then determined.

4.2.2 Bulk Density—Sand-Cone Method (ASTM D1556-82)

For determination of bulk density via the Sand-Cone Method, a template is placed on a level surface of the unstabilized/unsolidified waste and the material is excavated through a hole in the template with small digging tools. A volume of roughly 1000 to 2500 cm³ is typically excavated through the 165-mm-diameter hole in the template. An apparatus filled with a sand of known density is weighed and placed on the template above the hole created by the excavation. Sand is released from the apparatus and allowed to fill the hole. The apparatus is then reweighed. From the sand's previously determined density and the weight of sand remaining in the apparatus, the volume of the sand needed to fill the hole is calculated. The ratio of the weight of material removed from the hole to the volume of sand needed to fill the hole is the material's bulk density. The moisture content is determined on a sample of the excavated material to evaluate dry density.

4.2.3 Bulk Density—Nuclear Method (ASTM D2922-81)

The density of soil and soil aggregate can also be measured in place by nuclear methods. The total or wet density of the material is determined by placing a gamma source and gamma detector either on, into, or adjacent to the material to be measured. Nuclear densitometry works on the principle of Compton scattering. The amplitude of back-scattered gamma radiation depends on the electron concentration in the material being measured, and this is, in turn, roughly proportional to the density of the material.

4.2.4 Bulk Density—Stabilized Waste

For determination of the bulk density of a monolithic stabilized waste, a sufficiently cured cube or cylinder of the solid is weighed and measured. The bulk density is then calculated by dividing the volume into the mass.

Bulk density measurements are used for materials-handling calculations such as volume removed, volume stabilized, and volume returned to the site. Bulk density measurements of stabilized materials are used to determine the amount of material that will need to be shipped offsite or to determine the degree of mounding that will occur as a result of stabilization/solidification. These applications are similar to cut-and-fill calculations for construction or road building.

For 69 stabilized/solidified products tested by Stegemann et al. (1988), bulk densities ranged from lighter than water (0.7 g/cm^3 or 0.6 ton/yd^3) to very dense (2.2 g/cm^3 or 1.8 ton/yd^3).

4.3 Compaction Testing—Moisture/Density of Soil-Cement Mixtures

This test (ASTM D558-82) determines the relationship between the moisture content and density of soil-like materials. The test is normally completed on the stabilized waste before stabilization/solidification has occurred. The test determines the moisture content that allows maximum compaction to occur so as to achieve maximum density.

4.3.1 Test Description

The optimum moisture content is obtained by creating a series of samples for the particular waste-stabilization/solidification agent mix to be tested. Varying amounts of water are added to these samples, which are then placed in a standard mold with a volume of $1/30 \text{ ft}^3$ and compacted in three equal lifts by use of a standard 5.5-lb rammer dropping from a height of 12 inches. After compaction, the samples are oven-dried for 12 hours, and their densities are then measured. The baseline moisture content (before the addition of water) is also noted.

Dry densities of the stabilized samples are plotted as a function of moisture content. This plot produces a curve as shown in Figure 4-3. Note: The moisture content of samples may reflect moisture added for testing purposes.

The moisture content corresponding to the peak of the curve is called the "optimum moisture content." The density corresponding to the peak of the curve is called the "maximum density."

4.3.2 Interpretation and Application of Results

The moisture content of a stabilized waste is applicable for soil-like stabilized wastes that must be re-compacted in place after they are stabilized. Experience in the construction fields shows that it is difficult to achieve proper compaction if materials are too wet or too dry. Water lubricates soil particles, which helps them slide into a denser position. The stabilized waste has an optimum moisture content at which a maximum density can be achieved upon compaction. It should be noted, however, that the optimum water content for compaction properties may not be the optimum water content for hydration reactions.*

* Personal communication from Dr. Paul L. Bishop, University of Cincinnati, on September 30, 1988.

Figure 4-3. Typical soil-cement moisture/density relationship.

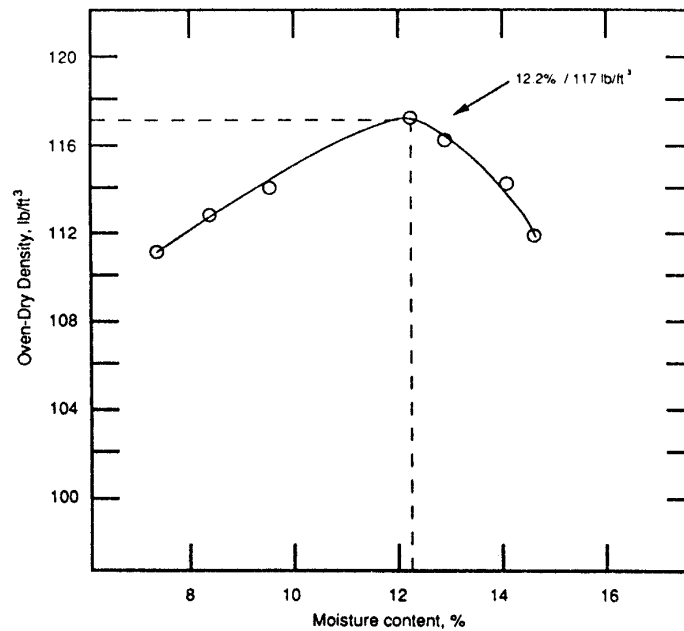

4.4 Permeability (Hydraulic Conductivity) Testing

Hydraulic conductivity, often referred to as permeability, is a measure of the resistance of a material to the passage of water. Permeability tests are performed to estimate the quantity and flow rates of water through a material under saturated conditions. Laboratory permeability testing consists of applying a hydraulic head of water to one end of a specimen and measuring the flow through the specimen (Carter 1983).

There are two basic types of permeability tests: constant-head and falling-head. The constant head test allows relatively large quantities of water to flow through the sample and be measured. This test is suitable for materials with a permeability greater than 10^{-6} cm/s. The falling-head test, which allows for more accurate measurement of small quantities of water, is more suitable for materials with a permeability of less than 10^{-6} cm/s (Carter 1983). The following are general descriptions of the testing techniques.

Falling-Head Permeability (EPA Method 9100-SW846) (Figure 4-4)

In this test, a specimen is sealed in an impermeable membrane and placed in a fluid-filled chamber, within which hydrostatic pressures can be applied to the specimen (a triaxial compression chamber with back pressure to

ensure complete saturation is commonly used). Platens on the top and bottom of the specimen are connected through tubing to cylinders filled with air-free water. The water in the chambers is differentially pressurized to create a head difference across the specimen and to force flow through the specimen. The pressure differential must be specified. If the differential is very high, problems can result from expansion of internal pores and creation of a more continuous flow network, which results in erroneously high permeability readings.* The elapsed time for the water level to fall between calibrated marks on the glass cylinder is recorded. The test is usually repeated three or four times. The falling-head permeameter is usually equipped with a series of glass tubes of various diameters to allow a reasonable time interval to be used for the test. Selection of the correct size tube is based on judgment and accomplished by trial and error. Figure 4-4 is a schematic diagram of the apparatus required for this test.

Constant-Head Permeability (EPA Method 9100-SW846) (Figure 4-5)

In this test, the sample is placed in a water bath and is connected to a column of air-free water in a glass tube, with the head of the water maintained at a constant value by a

* Personal communication from Dr. Paul L. Bishop, University of Cincinnati, to M. Arozarena, PEI, September 30, 1988.

Figure 4-4. Basic layout of apparatus for falling-head permeability test.

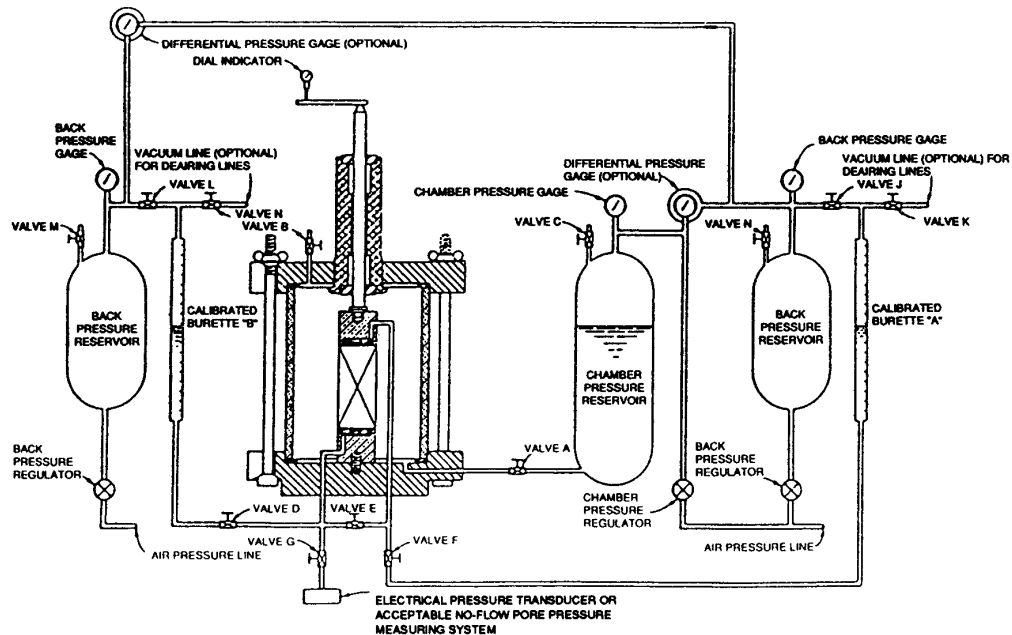

header tank and a balance tank. Water flows through the sample by gravity and is collected in a measuring cylinder. The time taken to collect a given quantity of water is recorded. The cylinder containing the soil sample usually has nipples at a number of points along the sides and is connected via rubber tubing to glass manometer tubes so that the piezometric head can be measured at various points throughout the specimen (Carter 1983). Figure 4-5 is a schematic diagram of the apparatus required for this test.

Figure 4-5. Basic layout of apparatus for constant-head

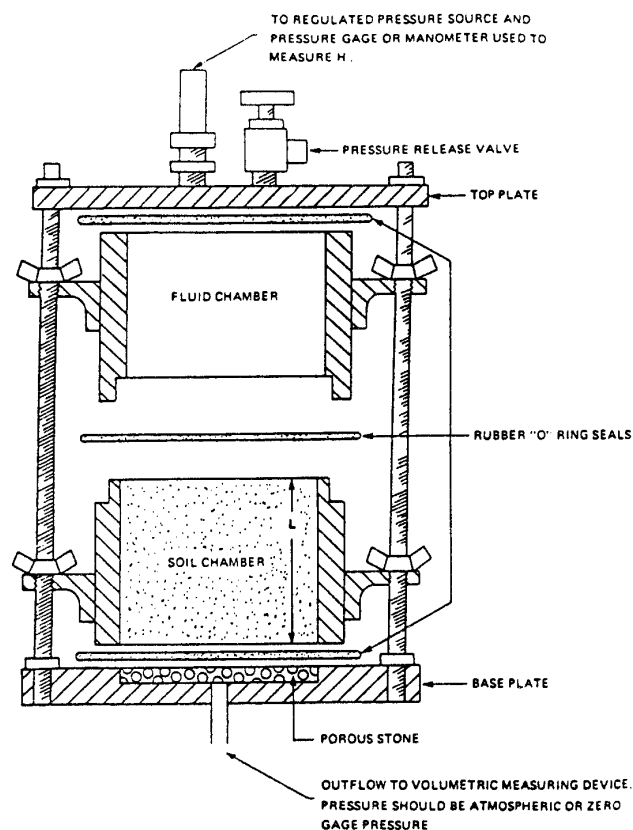

Both of these permeability tests are laboratory methods and are only considered accurate to within one order of magnitude. If a soil-like waste is stabilized and sampled in the field for testing in the laboratory, it is necessary to recompact the sample in accordance with USACE methods (USACE 1980) to obtain a representative sample.

The permeability of a stabilized waste is an important factor, as it indicates the ability of a material to permit the passage of water and to limit the loss of contamination from the stabilized waste to the environment. Permeability is examined in conjunction with leach test results to evaluate the potential of the stabilized waste to release contaminants into the environment.

The relevance of permeability measurements can be understood by comparing them with natural materials. Sand, a highly permeable material, has a hydraulic conductivity on the order of 10^{-2} cm/s. Clay, a material that is used to line lagoons and surface impoundments, can have hydraulic conductivity on the order of 10^{-6} cm/s or less and is considered relatively impermeable. Thus a stabilized waste with a permeability similar to clay is desirable because it will not permit the free passage of water through the stabilized waste. By slowing the contact of water with the waste, it reduces the possible transport of contaminants out of the waste. Typical hydraulic conductivities for stabilized wastes range from 10^{-4} to 10^{-8} cm/s. Hydraulic conductivities of less than 10^{-5} cm/s (upflow triaxial procedure) are recommended for stabilized waste destined for land burial (USEPA 1986e).

Highly permeable materials are not necessarily undesirable. If the stabilized waste does not readily leach contaminants into the water, a high permeability is not as important. High permeability values can also be addressed through engineering solutions such as construction of impermeable liners and covers. Finally, relative permeability can be just as important as actual permeability. The permeability of stabilized/solidified materials should be two orders of magnitude below that of the surrounding materials.

Permeability tests may also be completed on stabilized samples that have undergone durability testing. The durability tests mimic natural stresses that are applied to the stabilized samples (e.g., freeze/thaw weathering) (see Section 4.6). Permeability can potentially increase over time as a result of natural stresses.

4.5 Strength Testing

Strength-test values indicate how well a material will hold up under mechanical stresses created by overburden and earth-moving equipment. Strength-test data also are often used to provide a baseline comparison between unstabilized and stabilized wastes. Unstabilized waste materials generally do not exhibit good shear strength; however, if the waste is stabilized into a cement-like form, the strength characteristics can be expected to increase significantly. Correlation between strength and contaminant leachability has not been widely demonstrated.

Several other strength tests may be performed in addition to or in place of the tests described in the following subsections, depending on the intended use of the data. These include ASTM D1883-87, California Bearing Ratio of Laboratory-Compacted Soils, and ASTM C109-86, Compressive Strength of Hydraulic Cement Mortars.

4.5.1 Unconfined Compressive Strength of Cohesive Soils (ASTM D2166-85)

The Unconfined Compressive Strength measures the shear strength of a cohesive, soil-like material in unsaturated undrained conditions without lateral confinement on the sample. The test method provides an approximate value of the strength of cohesive soils (wastes) in terms of total stress. The soil (waste) may be undisturbed, remolded, or recompacted. The test is applicable to cohesive materials that do not expel water during the loading portion of the test. (Water is expelled from soil as a result of deformation or com-

paction.) Dry, crumbly, or fissured materials cannot be tested with this method.

4.5.1.1 Test Description

The test is completed by centering a specimen (prepared in accordance with ASTM D1632-87) on an apparatus containing upper and lower plates. The specimen is not supported laterally. The test is usually performed as a strain-controlled test, in which the specimen is subjected to a vertical strain rate of 0.5 to 2 percent per minute by applying axial load until the specimen fails. The test continues until the load values decrease with increasing strain, or until 15 percent strain is reached. The peak stress (at failure) is defined as the Unconfined Compressive Strength of the sample. For the assumptions made for this test (zero internal friction and zero minor principal stress), the shear strength equals the Unconfined Compressive Strength divided by two. The strain rate used for the test should be selected to achieve failure in less than 15 minutes. Load and deformation are recorded at sufficient time intervals to be able to plot a stress-strain curve (example in Figure 4-6). The moisture content of the sample is also determined (Subsection 4.1.3) because different moisture contents will change the shape of the curve.

4.5.1.2 Interpretation and Application of Results

Unconfined Compressive Strength results for unstabilized waste have limited application. They do, however, serve as a baseline for comparison with the Unconfined Compressive Strength results for stabi-

Figure 4-6. Stress-strain curve.

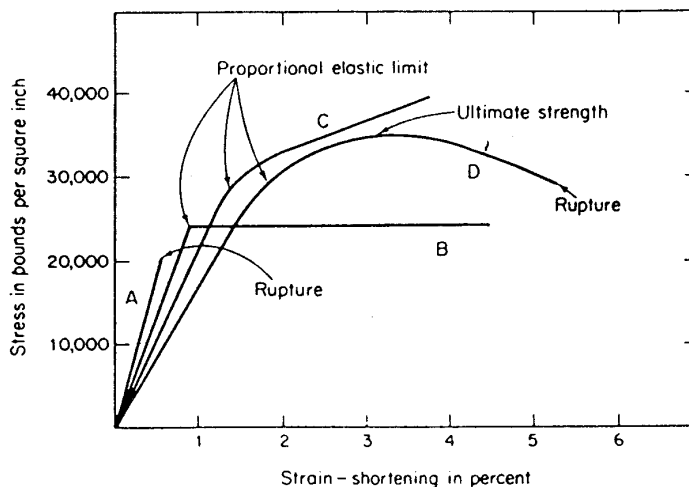

Source: Structural Geology, third edition, by Marland P. Billings. Prentice-Hall, Inc., Englewood Cliffs, NJ.

lized waste. If the unstabilized product is soil-like and the stabilized product is cement-like, there should be a marked increase in the Unconfined Compressive Strength (10 to 20 psi).

4.5.2 Unconfined Compressive Strength of Cylindrical Cement Specimens (ASTM D1633-84)

For stabilized cement-like wastes, the Unconfined Compressive Strength test can provide several pieces of useful information, including the following:

- The ability of the stabilized waste to withstand overburden loads.
- The optimum water/additive ratios and curing times for cement setting reactions.
- The improvement in strength characteristics from the unstabilized to the stabilized waste.

This test also is often conducted on samples subjected to durability tests (Subsection 4.6).

4.5.2.1 Test Description

The test is completed on a cylindrical sample of the materials (ASTM D1632-87). It can be completed with two different cylinder height-to-diameter ratios: 1.15 and 2.0 (Methods A and B). The cylindrical test specimen must be cured for a specified time in a room with 100 percent humidity. Typical curing times for cement are 1, 7, 14, and 28 days. The age of the tested sample should be noted.

The two height-to-diameter ratios cause several differences in testing and in results. Method A uses equipment more readily available in soil-testing laboratories; however, this test method may lead to more complex stress conditions during crushing. Therefore, Method A gives a relative measure of strength rather than a rigorous determination as found in Method B. Method A normally yields a higher compressive strength than an identical sample tested by Method B. Although no consistent preferences in test methods are noted in the literature, comparisons in Unconfined Compressive Strength should only be completed for samples tested by the same method.

The testing apparatus is commonly called a "Compression Testing Machine." The machine may take on several forms, but most important, it must be able to control the rate at which load (stress) is applied. The machine has an upper and lower plate, and the sample is placed upright (long axis vertically) on the lower plate.

The upper plate is lowered and brought into contact with the sample. Load is added continuously without shock by a screw. A sample fails when it loses its physical integrity by falling apart. The total load at failure of the test specimen is recorded to the nearest

10 pounds of force. The Unconfined Compressive Strength is the ratio of force applied at failure to the original cross-sectional area of the cylinder, usually expressed in pounds per square inch (psi). Unconfined Compressive Strength is often expressed in other units. Table 4-3 presents conversion factors for the more common units.

In its methods description, ASTM reports that the average strength difference of two duplicate samples is 8.1 percent. The samples should be tested by the same person to give the maximum precision when interpreting the failure of the sample.

4.5.2.2 Interpretation and Application of Results

The EPA considers a stabilized/solidified material with a strength of 50 psi to have a satisfactory Unconfined Compressive Strength (USEPA OWSER Directive, No. 9437.00-2A). This minimum guideline of 50 psi has been suggested to provide a stable foundation for materials placed upon it, including construction equipment and impermeable caps and cover material. A study by Stegemann et al. (1988) reported Unconfined Compressive Strength values for 69 stabilized/solidified wastes ranging from 10 to 2900 psi.

The minimum required Unconfined Compressive Strength for a stabilized/solidified material should be evaluated on the basis of the design loads to which the material will be subjected. The anticipated overburden pressure and other loads, along with appropriate safety factors, can be used to calculate this.

Typical construction and compaction equipment can generate very high contact pressures of 1000 psi or more (e.g., sheepfoot rollers), but surface contact pressures on the order of 50 to 100 psi are more common. This surface load is attenuated with depth so that bearing pressures are reduced to values on the order of 10 to 20 psi at a depth of 2 feet and 3 to 7 psi at a depth of 5 feet below grade. Overburden pressures will usually be on the order of 0.75 to 1.0 psi per foot of depth. If guidelines such as these are used, the stresses to which the stabilized/solidified waste will be subjected can be predicted, and design criteria can be selected accordingly.

Martin et al. (1987) suspect that one-dimensional compressibility may be a more useful indicator of mechanical stabilization/solidification in some situations than is Unconfined Compressive Strength. The one-dimensional compressibility test (e.g., ASTM D2435-80) allows a prediction of fluid expulsion during consolidation and evaluation of cover support. For stabilized/solidified waste forms that are relatively soft or ductile, this test can provide useful performance information; however, for stiff, cement-like, stabilized/solidified waste, the Unconfined Compressive Strength with a rational design criterion is probably

Table 4-3. Unconfined compressive strength conversion factors^a.

Units	Units						
	psi	kg/cm ²	lb/ft ²	tons/ft ²	newtons/cm ²	pascals (newtons/m ²)	
1 psi =	1	0.070	144	0.072	0.689	6895	
1 kg/cm ² =	14.2	1	2048	1.024	9.81	9.81 x 10 ⁴	
1 lb/ft ² =	0.007	4.88 x 10 ⁻⁴	1	0.001	0.005	47.9	
1 ton/ft ² =	13.89	0.976	2000	1	9.58	9.58 x 10 ⁴	
1 newton/cm ² =	1.45	0.102	208.9	0.104	1	10 ⁴	
1 pascal (newton/m ²) =	1.45 x 10 ⁻⁴	1.02 x 10 ⁻⁵	0.021	1.04 x 10 ⁻⁵	10 ⁻⁴	1	

a To convert the numerical value of a property expressed in one of the units in the left-hand column of the table to the numerical value of the same property expressed in one of the units in the top row of the table, multiply the former value by the factor in the block common to both units.

adequate for most situations.

Compressive Strength of Hydraulic Cement Mortars (ASTM C109-86) is often used in place of ASTM D1633-84. It is similar to ASTM D1633-84; however, cubic specimens, which require less material to form, are used instead of cylindrical specimens.

The shape of the stress-strain curve is indicative of the relative stiffness of the stabilized/solidified material. Thus, the shape of the curves can provide some insight as to whether problems with creep or consolidation of ductile behavior or cracking due to brittle or rigid behavior are possible.

4.5.3 Flexural Strength (ASTM D1635-87)

Flexural strength is a measurement of a material's ability to withstand loads applied in tension. During this testing, the loads are considered for the short axis of the sample. In contrast, the loads are applied to the long axis of the sample when the unconfined strength is measured.

4.5.3.1 Test Procedures

This test is completed on apparatus such as that illustrated in Figure 4-7. The specimen should be kept moist after curing and be tested as soon as possible after removal from the moist environment. The stabilized/ solidified specimen (ASTM D1632-87) is placed on the apparatus, which supports the specimen at both ends. The head of the testing apparatus consists of a mass supported by two half-rods made of steel. The head is placed at the center of the specimen. The two end supports and the head produce four points of contact on the specimen. Load is applied to the head of the apparatus, which produces a stress at the center of the specimen. The force is applied perpendicularly to the long axis of the specimen to test

the flexibility of the specimen. Load is added slowly to the specimen until failure. The load necessary to produce failure of the specimen is recorded to the nearest 10 pounds. If the machine uses a hydraulic press for loading stress, the rate of loading should not be greater than 100 psi per minute. After the specimen fails, the average width and depth of the specimen at the point of failure are measured to the nearest 0.01 inch.

4.5.3.2 Interpretation and Application of Results

The results are a measurement of the strength of a stabilized/solidified waste in terms of cracking in flexure. The results indicate resistance of the stabilized/ solidified waste to cracking due to settlement of the underlying fill or due to surface loads. Flexural strength can be viewed as a performance criterion that is dependent on the disposal conditions. It is most appropriate when a material is subject to surface loads after placement or when differential settlement of subgrade materials is possible.

Use of this measurement would be appropriate if a waste were stabilized/solidified and compacted in a disposal cell in a series of lifts or layers. A problem could arise if the first lift were a stiff layer compacted over a soft bedding. In such a case, the compacted layer must have sufficient flexural strength to support the vehicle operations during the installation of the upper lifts. The compacted layer also must have enough strength to support the upper lifts without flexure. In either case, if the lift of compacted material does not have sufficient strength to support surface loads, the compacted material will crack and zones of high permeability and increased potential of leaching will be formed.

Figure 4-7. Schematic of apparatus for flexure test of soil-cement by third-point loading method.

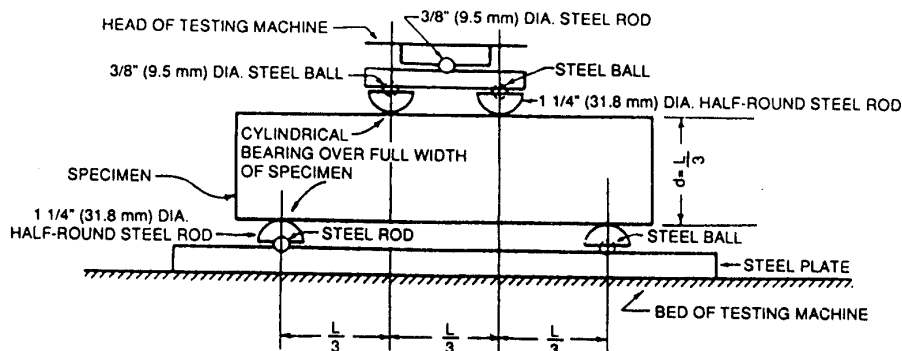

Source: The American Society for Testing and Materials, 1916 Race St., Philadelphia, PA 19103.

4.5.4 Cone Index (ASTM D3441-79)

A material's cone index is indicative of its stability and bearing capacity. The cone index test involves forcing a standard cone-shaped device into the stabilized/solidified waste being tested and measuring the penetration resistance offered by the material (Cullinane 1986).

Cone penetration tests are suited for testing stabilized/solidified sludges or other wastes for landfilling. The test helps to determine the types of vehicles needed to move and place material and the curing time required before other construction equipment can move over it [time before it can be used as subgrade (Tittlebaum and Seals 1985)].

4.5.4.1 Test Description

Various types of cone penetration tests have been used. One commonly used test involves placing a sample of soil-like stabilized/solidified waste in a cup at the bottom of a standard testing apparatus and scraping it level with the top of the cup with a palette knife. A standard metal cone on a shaft is held in place by a clamp. At the beginning of the test the tip of the cone is just touching the surface of the sample. When the clamp is released, the cone penetrates the sample. After 5 seconds, the clamp is closed and the penetration is halted. The distance the cone has penetrated the sample is measured to the nearest 0.1 mm with a dial gauge. The test is repeated to check precision.

4.5.4.2 Interpretation and Application of Results

The cone index was originally developed to determine the "trafficability" of compacted materials, which means it shows the ability of a compacted material to support construction equipment.* Test results are used to determine when a material is able to support the load of specific construction equipment. It is an important parameter in terms of logistical and cost considerations at a site. It is often imperative for equipment to be able to move over the stabilized/solidified waste as quickly as possible to continue work on other sections of the disposal area.

The cone penetration test is practical and inexpensive. Proponents of this test claim that its results can be used in lieu of the Unconfined Compressive Strength test in certain instances (e.g., when a rapid

turnaround is required).* Exclusive use of the cone index test, however, would require laboratory correlation between it and the Unconfined Compressive Strength test. The test is also easy to complete in the field by use of a Pocket Penetrometer (Figure 4-8), which works on the same principle as the cone index apparatus just described.

4.6 Durability Testing

Durability testing evaluates the resistance of a stabilized/solidified waste mixture to degradation due to external environmental stresses. The tests are designed to mimic natural conditions by stressing the sample through 1) freezing and thawing, and 2) wetting and drying. The stabilized/solidified specimens undergo repeated cycling during the testing. Unconfined Compressive Strength, flexural strength, permeability, or other performance-based tests may be conducted on the stabilized/solidified samples after each cycle to determine how the physical properties of the stabilized/solidified waste change as a result of simulated climatic stresses. The number of cycles a material can withstand without failing can be used to judge the mechanical integrity of the material.

Figure 4-8. Photograph of a pocket penetrometer.



Photograph courtesy Gilson Company, Inc., Worthington, Ohio.

* Personal communication from M. John Cullinane, U.S. Army Corps of Engineers, Waterways Experimental Station, August 3, 1988.

4.6.1 Freezing and Thawing Test of Solid Waste (ASTM D4842)

Seven molded samples (44 mm in diameter x 74 mm in length) are cured in moist containers for 28 days. One sample is selected for moisture content determination by drying to constant weight in accordance with ASTM D2216-80, revised to use a temperature of $60^{\circ}\text{C} \pm 3^{\circ}$. Three samples are subjected to testing and three are control samples. Each of the test specimens is weighed and subjected to 24 hours of freezing at $-20^{\circ}\text{C} \pm 3^{\circ}$. The controls are kept in the moist containers for 24 hours.

After 24 hours, the samples are covered with distilled water and allowed to sit for another 23 hours. The samples are then removed from their beakers with tongs, and loosely attached particulates are removed by spraying distilled water from a wash bottle onto the surface of the specimen. The samples are then observed for physical deterioration and their weight loss is measured (solids content in beakers by evaporating water at $60^{\circ}\text{C} \pm 3^{\circ}$ in drying oven). The freeze-thaw cycle is repeated for a total of 12 cycles or until the weight loss (corrected against the weight loss of control samples) of any of the specimens exceeds 30 percent.

4.6.2 Wetting and Drying Test of Solid Wastes (ASTM D4843)

Seven molded samples (44 mm in diameter x 74 mm in length) are cured in moist containers for 28 days. One sample is selected for moisture content determination by drying to constant weight in accordance with ASTM D2216-80, revised to use a temperature of $60^{\circ}\text{C} \pm 3^{\circ}$. Three samples are subjected to testing and three are control samples. Each of the test specimens is weighed and subjected to 24 hours of drying at $60^{\circ}\text{C} \pm 3^{\circ}$.

After 24 hours, the samples are allowed to sit for 1 hour and then covered with distilled water for another 23 hours. The samples are removed from their beakers with tongs, and loosely attached particulates are removed by spraying distilled water from a wash bottle onto the surface of the specimen. The samples are

then observed for physical deterioration and their weight loss is measured (solids content in beakers by evaporating water at $60^{\circ}\text{C} \pm 3^{\circ}$ in drying oven). The wetting and drying cycle is repeated for a total of 13 cycles or until the weight loss (corrected against the weight loss of control samples) of any of the specimens exceeds 30 percent.

4.6.3 Interpretation and Application of Results of Durability Tests

These tests relate to the long-term stability of the sample. If the results show low loss of materials and retention of physical integrity after testing, the stabilization/solidification process and agent-to-mix ratio are adequate. If the test results show a large loss of material and loss of physical integrity, a different waste-to-agent ratio or different stabilization/solidification agent should be used to provide the long-term stability needed.

No standards are currently established for determining whether stabilized material has passed durability testing; however, Vick et al. (1987) suggest that 15 percent weight loss is an acceptable amount. Because very few materials can withstand the full 12 cycles, the only true measure is a comparison of the results with another stabilization/solidification test (i.e., how many cycles can one mixture withstand versus a different mixture). Obviously, if a cement-like stabilized/solidified waste requires good strength characteristics for proper disposal and it loses its physical integrity during testing, one can conclude that a different stabilization/solidification agent or waste to agent ratio needs to be used.

Poor durability results often can be addressed by a change in design and should not be used as automatic grounds for exclusion. For example, materials that fail freeze-thaw durability testing can be placed below the frost line to mitigate their poor durability property.

Section 5

Chemical Testing Procedures

This section is devoted to a discussion of leaching tests, as these are the tests most often used to evaluate the performance of stabilization/solidification as a treatment process for hazardous waste. Emphasis is on the appropriate selection of leaching tests and the interpretation of laboratory results. Also highlighted are the experimental conditions affecting the reproducibility of the laboratory data and the limitations in extrapolating test results to the field.

Chemical testing procedures applicable to untreated hazardous wastes may also have application to stabilized/solidified wastes. Table 5-1 lists general parameters, test methods, specific applications to untreated and stabilized/solidified wastes, and references.

5.1 Overview of Leaching Mechanisms and Leach Tests

In the field, leaching of hazardous constituents from stabilized/solidified wastes (waste forms) is a function of both the intrinsic properties of the waste form and the hydrologic and geochemical properties of the site. Although laboratory physical and chemical tests can be used to define the waste form's intrinsic properties, the controlled conditions of the laboratory environment are usually not equivalent to changing field conditions. At best, laboratory leaching data can simulate the behavior of waste forms under "ideal," static (conditions at one point in time), or "worst-case" field conditions. Presently, leach tests can be used to compare the effectiveness of various stabilization/solidification processes, but they have not been verified for determining the long-term leachability of the waste.

5.1.1 Leaching Mechanisms

Leaching of a porous medium in the field is generally modeled by solute transport equations that incorporate the following factors:

- Chemical composition of waste and leaching medium
- Physical and engineering properties (e.g., particle size, porosity, hydraulic conductivity) of the waste and surrounding materials
- Hydraulic gradient across the waste

The first factor includes the chemical reactions and kinetics between the leaching fluid and the waste that transform contaminants from an immobile form to a mobile form. The last two factors are used to define the transport of fluids and mobilized contaminants through the waste material.

The physical and engineering properties of the waste material and the hydraulic gradient determine how a leaching solution contacts the waste material. The hydraulic gradient, together with effective porosities and permeabilities, governs the velocity and quantity of the leaching solution migrating through the waste form. For example, if the waste is relatively impermeable (i.e., has low hydraulic conductivity) compared with the surrounding material, the leaching solution will tend to flow around the waste form. This can occur when an intact stabilized/solidified waste form is disposed of in a medium with a hydraulic conductivity 100 times greater (i.e., 10^{-6} to 10^{-4} cm/s). In such cases, most of the contact between the leaching solution and the waste form occurs at the geometrical surface of the waste form. The permeability of stabilized/solidified wastes can increase over time through physical and chemical weathering processes, however, and increase the amount of liquid flow through the waste. Therefore, in the long run, contact between the leaching solution and the waste will occur at the particle surface within the waste form.

The chemistry of the waste and the leaching solution defines the types and kinetics of the chemical reactions that mobilize or demobilize contaminants in the stabilized/solidified waste. Reactions that can mobilize contaminants adsorbed or precipitated within the waste form include dissolution and desorption. Under nonequilibrium conditions, these reactions compete with demobilizing reactions such as precipitation and adsorption. Nonequilibrium conditions generally develop when a stabilized/solidified waste is contacted by a leaching solution and can result in a net transfer, or leaching, of contaminants into the leaching solution.

The following chemical kinetic factors affect molecular diffusion of pollutants within the waste form:

Table 5-1. General chemical test methods that may also have application to stabilized/solidified wastes.

Parameter	Test method	Applicability to untreated and stabilized/solidified wastes	Reference ^a
pH	EPA Method SW-9045	Leachability of hazardous constituents (e.g., metals) may be governed by the pH of the solid	1
Oxidation/reduction potential (E _H)	ASTM D1498-76	Changes in E _H after treatment can change the leachability of many elements	2
Major oxides	ASTM C114	Mineralogy of the stabilized/solidified waste may aid in interpretation of leach test results	3
Total organic carbon (TOC)	Combustion Method	Used to approximate the nonpurgeable organic carbon in wastes and treated solids	4
Oil and grease	EPA Method 413.2	May be used to compare the leachable oil and grease from the treated and untreated wastes	5
Elemental analysis	EPA Method SW-846	Used to determine the fraction of metals leached to the total metals content of the untreated and stabilized/solidified wastes	1
Volatile organic compounds (VOCs)	EPA Method SW-846 (Methods 5030 and 8240)	Used to compare VOC concentrations in stabilized/solidified wastes and untreated wastes with the VOC concentrations in TCLP extracts to determine relative leachability of the treated and untreated wastes	1
Base, neutral, and acid compounds (BNA)	EPA Method SW-846 (Methods 3540, 3520 and 8270)	Used to compare BNA concentrations of leachates with respective concentrations in treated and untreated wastes to determine relative leachability of the treated and untreated wastes	1
Polychlorinated biphenyls (PCBs)	EPA Method SW-846 (Methods 3540, 3520, 680, and 8080)	Same as for VOC with respect to PCB leachability from treated and untreated wastes	6
Ion measurements	Std. Method No. 429	Used to determine leachate ionic species concentrations	7
Heat of hydration	ASTM C186-86	Measurement of temperature changes during current mixing will allow prediction of VOC emissions in the field	8
Alkalinity	Titrometry	Alkalinity changes in leachates may be used to determine changes in stabilized/solidified waste form	9,10

^a Reference:

- 1 U.S. Environmental Protection Agency. 1986. Test Methods for Evaluating Solid Waste. Volumes 1A-1C: Laboratory Manual, Physical/Chemical Methods; and Volume II: Field Manuals, Physical/Chemical Methods, SwW846, Third Edition, Office of Solid Waste. Document Control No. 955-001-00000-1.
- 2 ASTM D1498-76, Standard Practice for Oxidation-Reduction Potential of Water.
- 3 American Society for Testing and Materials. 1981. Standard Methods for Chemical Analysis of Hydraulic Cement, ASTM Committee C-1 on Cement, Philadelphia, Pennsylvania. July 1981.
- 4 Perkin Elmer 240C Users Manual.
- 5 U.S. Environmental Protection Agency. 1979. Methods for the Chemical Analysis of Water and Wastes. Office of Research and Development. EPA-600 4-79-020, March 1979.
- 6 Albord-Stevens, Bellar, Erchelberger and Bubble, Method 680, November 1985, Determination of Pesticides, PCBs in Water and Sediment by GC-MS, Office of Research and Development, U.S. Environmental Protection Agency.
- 7 Standard Methods for the Examination of Water and Wastewater, 16th Edition, APHA, AWWA, WPCF, 1985. Washington, D.C.
- 8 ASTM C186-86. Standard Test Method for Heat of Hydration of Hydraulic Cement.
- 9 Bishop, P. L. 1986. Prediction of Heavy Metal Leaching Rates from Stabilized/Solidified Hazardous Wastes. In Toxic and Hazardous Wastes Proceedings of the 18th Mid-Atlantic Industrial Waste Conference.
- 10 APHA-AWWA-WPCF. 1975. Standard Methods for the Examination of Water and Wastewater, 14th Edition. Method 403. pp. 278-281.

- Accumulation of waste species in the pore solution at the particle surface.
- Concentration of reactive species (e.g., H⁺, complexing agent) in the pore solution at the particle surface.
- Bulk chemical diffusion of the waste or reactive species within the leachate pore solution or waste form.
- Polarity of the leaching solution and waste species.
- Oxidation/reduction conditions and competing reaction kinetics.

Because laboratory leaching tests usually involve standardized aqueous solutions (neutral, buffered, or dilute acidic solutions) rather than site-specific solutions, the results of the laboratory tests may not directly duplicate leaching in the field. As previously mentioned, laboratory leaching tests run with standard solutions can be used to compare the relative leachability of waste constituents under similar test conditions and with similar leaching solutions.

Depending on the physical and chemical properties of the waste and the leaching solution, the kinetics of contaminant transport (or leaching) in a porous medium are controlled by advective or dispersive/diffusive mechanisms. Advection refers to the hydraulic flow and subsequent solute transport of highly soluble contaminants in response to a hydraulic gradient. Dispersion refers to the transport of contaminants via mechanical mixing in the pore solution and molecular diffusion (the transfer of mass between adjacent layers of fluid in laminar flow). Because of the low permeabilities of most stabilized/solidified wastes, the rate of contaminant transport for adsorbed or chemically bonded constituents is generally considered to be controlled by molecular diffusion at the particular surfaces within the waste form, rather than advection or dispersion.

The buildup of chemical potential at the interface between particles and pore solution is the driving force for the diffusion-controlled transport of waste constituents within the aqueous solution and the waste form (Cote et al. 1987). This nonequilibrium condition is controlled primarily by the chemistry and velocity of the leaching solution.

Figure 5-1 shows the effect of the velocity of the leaching solution on the leaching rate of contaminants that are leached at the particle surface. Leaching solution velocity (v) is defined as the volume of leaching solution (V) contacted with waste per unit of surface area (SA) per unit of time (T):

$$v = V/(SA \times T)$$

Leaching rate (L) is the mass of the waste species (M)

leached per unit of surface area per unit of time:

$$L = M/(SA \times T)$$

The slope of the leaching curve in Figure 5-1 is the leachate concentration of the waste species in the leaching solution, or M/V . As shown in Figure 5-1, at high leaching solution velocities (rapid flow through the waste form), the leaching rate approaches the maximum, L_r . In addition, under rapid leaching solution velocities, leachate concentrations are very low (approaching zero) if leaching of the waste species is diffusion-controlled. High leaching rates and low leachate concentrations occur at the particle surface under rapid leaching velocities because nonequilibrium conditions at the particle surface are maintained. Rapid leaching rates occur in laboratory studies when the leaching solution is constantly being replenished with fresh solutions.

At low leaching solution velocities (i.e., static hydraulic conditions), the amount of a species leached approaches the saturation limit, S_l , or the maximum leachate concentration. Low leaching solution velocities and maximum leachate concentrations occur when the leaching solution is not replenished, and the same leaching solution is allowed to equilibrate with the waste.

These relationships between leachate concentrations and leaching solution velocities are important to the understanding and interpretation of leaching test results because the tests vary dramatically with leaching solution velocities, contact surface areas, leaching solution volumes, and time of leaching. The chemistry of leaching solutions also varies widely from neutral solutions to very acidic or strong chelating solutions.

5.1.2 Leaching/Extraction Tests

Numerous leaching tests have been developed to test solid wastes, including those developed specifically for stabilized/solidified nuclear and hazardous wastes. Because these tests have been developed by several different groups and specialists, the terminology applied to leaching tests has not been well established. Therefore, an attempt is made to clarify the terms used in this handbook with regard to leaching tests.

Extraction (or batch extraction) tests refer to a leaching test that generally involves agitation of ground or pulverized waste forms in a leaching solution. The leaching solution may be acidic or neutral. Also, it may vary throughout the extraction test. Extraction tests may involve one-time or multiple extractions. In either case, leaching is assumed to reach equilibrium by the end of one extraction period; therefore, extraction tests are generally used to determine the maximum, or saturated, leachate concentrations under a given set of test conditions.

Figure 5-1. Relationship between velocity of leaching solution and the leaching rate.

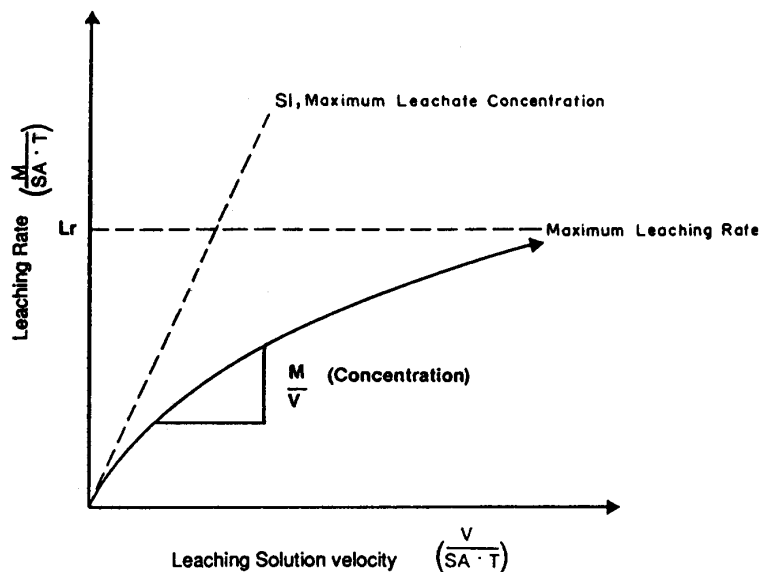

Source: Cote et al. 1987.

“Leach test,” another type of leaching test, involves no agitation. The leaching of monolithic (instead of crushed) waste forms is evaluated in these tests. Leaching may occur under static or dynamic conditions, depending on the frequency of the leaching solution renewal. In static leach tests, the leaching solution is not replaced by a fresh solution; therefore, leaching takes place under static hydraulic conditions (low leaching velocities and maximum leachate concentrations for monolithic waste forms). In dynamic leach tests, the leaching solution is periodically replaced with new solution; therefore, this test simulates the leaching of a monolithic waste form under nonequilibrium conditions in which maximum saturation limits are not obtained and leaching rates are high. “Static” and “dynamic,” therefore, refer to the velocity, not the chemistry of the leaching solution.

Results of dynamic leach tests are generally expressed in terms of a flux or mass transfer parameter (i.e., leaching rate), whereas data from extraction tests are expressed in terms of leachate concentration or cumulative fraction of total mass leached. Another key difference between these two leaching tests is that extraction tests are short-term tests lasting from hours to days, whereas leach tests generally take from weeks to years. Because of the crushed nature of the waste and the larger amount of surface area available for leaching, extraction tests (although short-term) are used to simulate “worst-case” leaching conditions. Leach tests on monolithic wastes (although longer in duration) are often used to simulate leaching under

“well-managed,” short-term scenarios in which the waste form is intact.

The column leach test is another type of laboratory leaching test. This test involves placing pulverized waste in a column, where it continuously contacts with a leaching solution at a specified rate. The leaching solution is generally pumped through the waste in an upflow column setup. Column tests are considered to be more representative of field leaching conditions than batch extraction tests because of the continuous flux of the leaching solution through the waste. This test is not often used, however, because of problems with the reproducibility of test results. These problems include channeling effects, nonuniform packing of the wastes, biological growth, and clogging of the column (Cote and Constable 1982). Nevertheless, column tests have been used along with extraction tests to study the effects of particle size on the leaching of heavy metals (Bishop 1986).

5.2 Leach Test Methods and Applications

This subsection presents a detailed review of the methods and general uses of several of the more common extraction and leaching tests. The following extraction tests are discussed:

- Toxicity Characteristic Leaching Procedure (TCLP)
- Extraction Procedure Toxicity Test (EP Tox)
- California Waste Extraction Test (Cal WET)

- Multiple Extraction Procedure (MEP)
- Monofilled Waste Extraction Procedure (MWEP)
- Equilibrium Leach Test (ELT)
- Acid Neutralization Capacity (ANC)
- Sequential Extraction Test (SET)
- Sequential Chemical Extraction (SCE)

The TCLP is used by EPA as the basis for the promulgation of best demonstrated available technologies (BDAT) treatment standards under the land disposal restrictions program. The EP Tox and Cal WET procedures are used by EPA and the State of California, respectively, for characterizing hazardous wastes. The remaining six tests provide useful information about maximum leachate concentrations under various conditions and the chemistry and waste constituents of the waste form.

In addition to the extraction tests, the following leach tests are also discussed:

- Materials Characterization Center Static Leach Test (MCC-1P)
- American Nuclear Society Leach Test (ANS-16.1)
- Dynamic Leach Test (DLT).

The MCC-1P and ANS-16.1 tests were developed for stabilized high- and low-radioactive wastes. The Dynamic Leach Test represents a modification of the ANS-16.1 leach test, which was developed for stabilized/solidified hazardous waste. These tests provide data for evaluating leaching rates (DLT and ANS-16.1) and maximum leachate concentrations (MCC-1P Static Leach Test) from intact waste forms leached with water.

Table 5-2 summarizes the main differences in test conditions among the nine extraction tests listed. The main experimental test variables in extraction tests are the leaching medium, the liquid-to-solid ratio, the particle sizes of the crushed waste sample, and the number and duration of the extractions. As shown in Table 5-2, leaching solutions in extraction tests vary from acids of different strengths and concentrations to distilled/deionized water. Liquid-to-solid ratios vary from as low as 3:1 (less acid added per gram of waste) to as high as 50:1 (more acid added per gram waste). Particle sizes range from less than 9.5 mm (larger particles and smaller contact surface area) to less than 0.15 mm (smaller particles and larger contact surface area). Extraction periods range from 2 hours to 48 hours, and the number of extractions range from 1 to 15. It is obvious that results from leach tests must be evaluated with an understanding of the differences in the experimental conditions.

5.2.1 Toxicity Characteristic Leaching Procedure (TCLP) (Federal Register 1986)

Waste samples are prepared by crushing the wastes to pass through a 9.5-mm screen, and liquids are separated from the solid phase by filtration through a 0.6- to 0.8- μ m borosilicate glass-fiber filter under 50 psi pressure. Two choices of buffered acidic leaching solutions are offered under TCLP, depending on the alkalinity and the buffering capacity of the wastes. Both are acetate buffer solutions. Solution No. 1 has a pH of about 5; Solution No. 2 has a pH of about 3. The leaching solution is added to a Zero Headspace Extractor (ZHE) at a liquid:solid ratio of 20:1, and the sample is agitated with a National Bureau of Stan-

Table 5-2. Extraction tests.

Test method	Leaching medium	Liquid:solid ratio	Maximum particle size	Number of extractions	Time of extraction
TCLP	Acetic acid*	20:1	9.5 mm	1	18 hours
EP Tox	0.04 M acetic acid (pH = 5.0)	16:1	9.5 mm	1	24 hours
Cal. WET	0.2 M sodium citrate (pH = 5.0)	10:1	2.0 mm	1	48 hours
MEP	Same as EP Tox, then with synthetic acid rain (sulfuric acid: nitric acid in 60:40 wt.% mixture)	20:1	9.5 mm	9 (or more)	24 hours per extraction
MWEP	Distilled/deionized water or other for specific sit	10:1 per extraction	9.5 mm or monolith	4	18 hours per extraction
Equilibrium leach test	Distilled water	4:1	150 μ m	1	7 days
Acid neutralization capacity	HNO ₃ solutions of increasing strength	3:1	150 μ m	1	48 hours per extraction
Sequential extraction tests	0.04 M acetic acid	50:1	9.5 mm	15	24 hours per extraction
Sequential chemical extraction	Five leaching solutions increasing in acidity	Varies from 16:1 to 40:1	150 μ m	5	Varies from 2 to 24 hours

* Two acetate buffered solutions: 1) pH = 5, 2) pH = 3.0

dards (NBS) rotary tumbler at 30 rpm for 18 hours. The leaching solution is filtered and combined with the separated liquid waste fraction for analysis.

The EPA proposed this test 1) to replace EP Tox as the criterion for defining hazardous and nonhazardous wastes, and 2) to be used for some listed wastes as the standard criterion for hazardous waste treatment. With the ZHE apparatus, TCLP can be used to evaluate the leaching of volatile and semivolatile organic compounds. It has also been used to evaluate maximum "worst-case" leachate concentrations achievable in the field; however, several studies (Bishop 1986, Barich et al. 1987, U.S. EPA 1988c) show that TCLP leaching of cement-based waste forms may not necessarily yield maximum concentrations. Multiple extraction tests, such as MWEF or MEP, may be needed to assess maximum leachate concentrations under different pH conditions.

5.2.2 Extraction Procedure Toxicity Test (EP Tox) (U.S. EPA 1986)

Similar to TCLP in experimental design, EP Tox generally yields comparable results (Newcomer et al. 1986). Considerably different results may be observed if the more acidic TCLP extraction fluid No. 2 (pH = 2.88 ± 0.05) is used. Table 5-3 summarizes the differences between the two test methods. The primary difference between EP Tox and TCLP is that the EP Tox leaching solution (only one solution of acetic acid at a pH of 5) is added periodically (up to a specified maximum acid addition) as needed to adjust the pH of the leaching solution during the course of the extraction. The TCLP solutions are buffered so that the leaching solution is added only once at the start of the extraction.

Table 5-3. Summary of procedural differences between EP TOX and TCLP.

Experimental parameter	TCLP	EP Tox
Filter size, µm	0.6-0.8	0.45
Filter pressure, psi	50	75
Leaching solution	Acetate buffered solution (pH ≈ 3 or 5)	Acetic acid (pH ≈ 5)
Period of extraction, h	18	24
Liquid:solid ratio	20:1	16:1

* California Code, Title 22, Article 11, pp. 1800.75-1800.82.

The EP Tox test also has been used to classify wastes as hazardous or nonhazardous. This test, however, is designed to determine semivolatile organic and heavy metal leachate concentrations; it does not include analysis of volatile organic compounds. Generally, EP Tox and TCLP yield similar leachate concentrations of metals. Studies by Newcomer, Blackburn, and Kimmell (1986) and Shively and Crawford (1987), however, indicate that TCLP extracts greater metal concentrations. The statistical mean TCLP leachate concentrations ranged from 1.0 to 3.0 times greater than those for EP Tox (Newcomer, Blackburn, and Kimmell 1986). Although EP Tox may also be used to evaluate maximum leachate concentrations, like TCLP, it should be used along with other extraction tests.

5.2.3 California Waste Extraction Test (Cal WET)*

As shown in Table 5-2, Cal WET differs from TCLP and EP Tox in the following parameters:

- Different leaching solution (sodium citrate buffered solution at pH of 5; or, for hexavalent chromium, distilled water)
- Smaller liquid:solid ratio (10:1)
- Smaller particle size (less than 2.0 mm)
- Longer extraction period (48 hours)

The State of California uses Cal WET to classify hazardous waste. Because of the different metal chelating ability of sodium citrate solution, Cal WET is a more stringent leach test than TCLP for some metals.

5.2.4 Multiple Extraction Procedure (MEP) (U.S. EPA 1986g)

Although MEP is not a regulatory leaching test, it has been used in some instances for delisting wastes. This test involves multiple (sequential) extractions of the crushed sample with a synthetic acid rain solution. The first extraction is performed with the acetic acid solution in accordance with EP Tox methods. The subsequent extractions are performed with the synthetic acid solution (concentrated sulfuric acid/nitric acid, 60/40 wt.%, diluted to a pH of 3). A total of nine extractions are usually performed; however, more extractions are possible if the last three extractions do not decrease the leachate concentrations.

Results obtained by MEP can be used to determine maximum leachate concentrations occurring under acidic conditions. This test can be used with EP Tox or with MWEF (multiple extraction test with water) to compare leachability of hazardous constituents under mild and acidic conditions.

5.2.5 Monofill Waste Extraction Procedure (MWEF) (U.S. EPA 1986f)

Formerly called the Solid Waste Leach Test (SWLT), MWEF involves multiple extractions of a monolith or crushed waste with distilled/deionized water. The sample is crushed to less than 9.5 mm, or it can be left intact if it passes the Structural Integrity Test (SW-846). Ultimately, however, monolithic samples of stabilized/solidified wastes can be crushed during the extraction test as a result of agitation by the rotary tumbler (Barich et al. 1987). The liquid:solid ratio is 10:1, and the sample is extracted with water four times (18 hours per extraction).

This test can be used to derive reasonable leachate compositions in monofilled disposal facilities, and this information can be used to assess waste-liner compatibility under mild leaching conditions. It also can be used with TCLP to determine delays in the release of hazardous constituents. In addition, results from MWEF can be compared with those from ELT to assess the maximum leachate concentrations achieved under mild leaching conditions.

5.2.6 Equilibrium Leach Test (ELT) (Environment Canada and Alberta Environmental Center 1986)

This leach test involves static leaching of hazardous constituents in distilled water. The particle size of the crushed sample (150 μm) is much smaller than that for TCLP and EP Tox to allow greater contact surface area and to reduce the time needed to achieve equilibrium conditions. Water is added once at a liquid:solid ratio of 4:1, and the sample is agitated for 7 days.

Like MWEF, ELT can be used to determine maximum leachate concentrations under mild leaching conditions. Although particle size and liquid:solid ratio are smaller for ELT, leachate concentrations from the two tests should be comparable if equilibrium conditions are achieved under both (Cote, Constable, and Moreira 1987). Sample heterogeneity and analytical limitations may cause differences.

5.2.7 Acid Neutralization Capacity (ANC) (Environment Canada and Alberta Environmental Center 1986)

Acid Neutralization Capacity (ANC) involves separate extractions of several predried, crushed, waste samples with leaching solutions of varying levels of acidity. The amount of sample is much smaller, the extraction is performed in test tubes and a rotary tumbler, and liquid-solid separation is accomplished by centrifuging instead of filtering. Particle size is less than 150 μm (-100 mesh), and the liquid-to-solid ratio of the extraction is 3:1. Ten samples (labeled 1 through 10) are extracted for 24 hours in one of 10 nitric acid solutions that increase incrementally in the

number of equivalents of acid added per gram of dried solid.

The ANC test is used to determine the buffering capacity of the stabilized/solidified waste form. Figure 5-2 illustrates the change in pH as increasing amounts of acid are added for cement-based waste forms. Stegmann, Cote, and Hannak (1988) conclude that for a wide range of metal- and organic-bearing wastes stabilized with proprietary agents, the amount of acid required to bring the pH down to 9 (where many metals are soluble) varied between 2 and 10 milliequivalents per gram (meq/g) of waste. For cement-based wastes, the ANC is generally about 15 meq/g (Cote and Bridle 1987).

Figure 5-2. Acid neutralization capacity for several stabilized/solidified synthetic sludge samples.

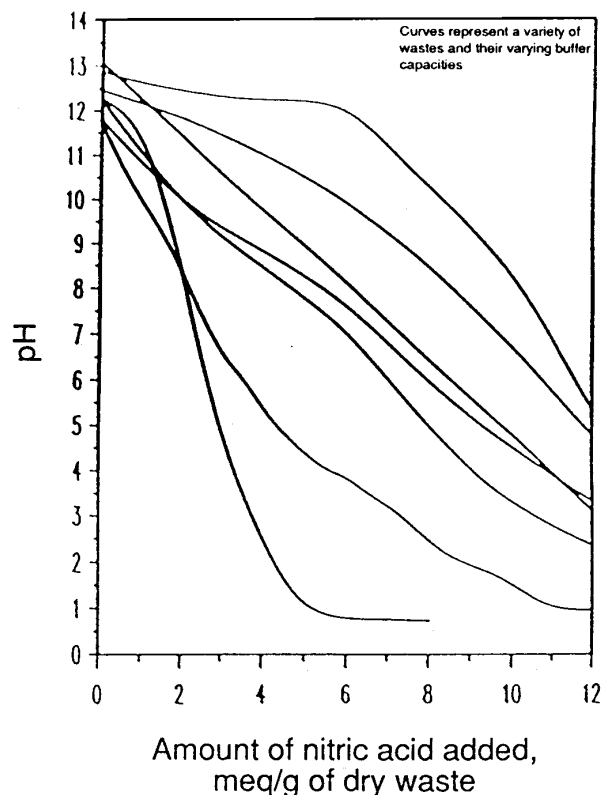

The higher the buffering capacity of the waste, the greater the possibility of maintaining alkaline conditions and minimizing the amount of metals leached. The buffering capacity of the waste form, therefore, is very important in evaluating the amount and rate of metals leached from stabilized wastes in the field.

5.2.8 Sequential Extraction Test (SET) (Bishop 1986)

The Sequential Extraction Test is also designed to evaluate the buffering capacity of the waste form. Unlike ANC, SET involves 15 sequential extractions of one sample of crushed waste with particle sizes between 2.0 and 9.5 mm. Each extraction is performed on a shaker table for 24 hours with the same extraction solution (0.04 M acetic acid solution) and a liquid:solid ratio of 50:1. With each extraction, 2 meq/g of acid is added to the ground waste. The pH is measured and the leaching solution is filtered. At the end of the fifteenth extraction, the remaining solids are digested with three more extractions in which more concentrated acid solutions are used. These last three extractions are combined for analysis.

Bishop (1986) and Shively et al. (1986) used SET to evaluate the waste buffering capacity and alkalinity of cement-based waste forms. They also correlated analyses of pH, alkalinity, dissolved solids, and metals to determine metal speciation within the waste form. Shively et al. (1986) and Bishop (1988) observed that the pH of the leaching solution remained above 10 during the first three extractions, and only anionic arsenic (As) appeared in the leachate. The leachate pH rapidly dropped to 6 during the next three extractions and then leveled out at 4 during the last nine extractions (Figure 5-3a).

The buffering species is primarily calcium hydroxide, based on gran analysis (Bishop 1986). Also, analyses of the extracts from the last three digestions indicate that from 75 to 85 percent of chromium, lead, and silicon dioxide were not leached during the 15 extractions, whereas only 8 percent calcium remained after 15 extractions (Bishop 1986). Based on similar release curves, chromium and lead are believed to be bound to the silicate matrix (Figure 5-3b). These studies indicate that the buffering capacity for cement-based waste forms is about 18 meq/g.

5.2.9 Sequential Chemical Extraction (SCE) (Environmental Canada and Alberta Environmental Center 1986)

This test was developed specifically to evaluate the species of organic and inorganic waste constituents in a stabilized matrix. Like SET, the test involves sequential extraction of a sample. Unlike SET, however, the leaching solution increases in acidity from neutral to very acidic with each sequential extraction. The particle size of the sample is also very small (less than 45 μm), and the sample is agitated on a Burrell wrist-arm shaker.

Results from the SCE test are used to interpret the bonding nature of metals and organics in the stabilized waste matrix. Contaminants leached in Fractions A, B, and C are interpreted to be available for

leaching, whereas those that are leached with concentrated acids (D and E Fractions) are considered to be unavailable for leaching. Studies by Bridle et al. (1987) and Stegmann, Cote, and Hannak (1988) indicate that metals are leached primarily in Fractions B and C, and thus are available for leaching in natural systems. They also conclude that this test cannot be used to determine speciation and bonding mechanisms for arsenic and mercury. Because of the lack of sensitivity indicated by the results from Fractions A through C, results from the SCE test should be used only to determine whether contaminants are potentially available or unavailable for leaching under the mild leaching conditions that may be encountered in the field (personal communication with P. L. Cote on July 14, 1988).

5.2.10 Materials Characterization Center Static Leach Test (MCC-1P) (MCC 1984)

This static leaching test was developed for high-level radioactive waste. It involves leaching of a monolithic waste form with water (ASTM Type I or II) at a ratio of volume of leaching solution to surface area solids (V/S) of between 10 and 200 cm. The period and temperature of extraction vary, depending on the schedule selected.

For organic and polymer stabilization/solidification processes, leachability should be evaluated by using MCC-1P or ANS-16.1, as these waste forms cannot be ground. In general, however, MCC-1P test results can be combined with those from extraction tests (e.g., TCLP, MWEP) to determine a range of leachate concentrations in the short term (well-managed site with waste form intact) and the long run (waste matrix has been subjected to many years of environmental stress and is fractured).

5.2.11 American Nuclear Society Leach Test (ANS-16.1, 1986) (ANS 1986)

A "quasi-dynamic" leach test, ANS-16.1, is applied to stabilized/solidified low-level and hazardous wastes. A monolithic cylinder (length:diameter of 0.2 to 5.0) is leached with demineralized water applied at a V/S ratio of 10 cm under ambient temperatures. At the start of the experiment, the sample is rinsed to obtain zero contaminant concentration at the surface of the sample. Afterwards, the sample is immersed in water, which is replaced after 2 hours, 7 hours, 24 hours, 48 hours, 72 hours, 4 days, 5 days, 14 days, 28 days, 43 days, and 90 days.

The results of the leaching test are recorded in terms of cumulative fraction leached over the total mass in the waste form, F. Calculations are then used to derive an effective diffusion coefficient, D_e (cm^2/s), and a leachability index ($LX = -\log D_e$). The LX values range from 5 ($D_e = 5\text{-}10$, rapid diffusion) to 15 ($D_e = 10\text{-}15$, very slow diffusion).

Figure 5-3. Sequential extraction test results: (a) Leachate pH and cumulative alkalinity leached from solidified/stabilized subjected to multiple-batch extraction procedure. (b) Cumulative heavy metal, silicone, and alkalinity leached from solidified/stabilized samples subjected to multiple-batch extraction procedure.

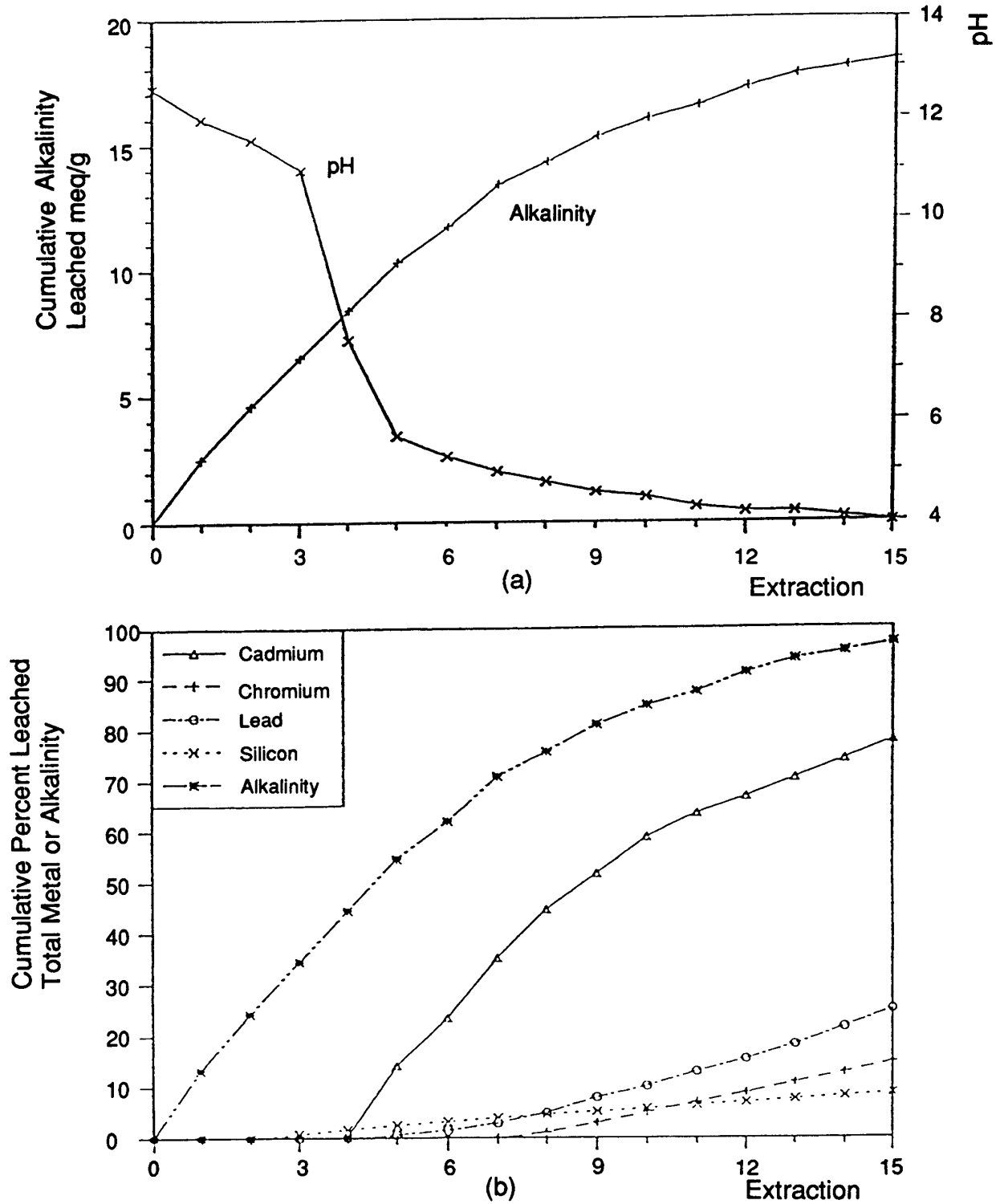

Interpretation of ANS-16.1 results assumes that leaching is diffusion-controlled and that nonequilibrium conditions are maintained during each leaching period. Because leaching rates for hazardous constituents vary widely and may not be diffusion-controlled, the leaching rates under an ANS-16.1 renewal schedule may actually be slower as leaching conditions become static (equilibrium conditions). Hence, the LX values obtained from ANS-16.1 results may be greater than those under the modified ANS-16.1 (Dynamic Leach) test, discussed in the next subsection.

5.2.12 Dynamic Leach Test (DLT) (Environmental Canada and Alberta Environmental Center 1986)

The Dynamic Leach Test is a modified version of the ANS-16.1. The only modification to the leach test is the renewal frequency of the leaching solution and the V/S ratio, which is based on known diffusion coefficients and results from batch extraction tests (e.g., ELT). The selected V/S ratio must ensure that the contaminant can be detected, and the renewal frequency for the leaching solution should ensure that nonequilibrium leaching conditions prevail. Otherwise, the extraction procedure, apparatus, and the subsequent calculations for deriving LX values are the same.

The leaching data must be checked for the following criteria:

- Cumulative fraction leached, F , increases linearly with $T^{1/2}$, where T is time.
- Concentrations leached during one leaching period are less than the maximum, or saturated, concentrations.
- F is less than 0.2.

The linear relationship between F and the square root of time verifies that leaching rates are diffusion-controlled. If leaching is occurring through dissolution or convective mechanisms, the relationship would not be linear. If leachate concentrations are less than the saturated concentrations, leaching is occurring under nonequilibrium conditions and approaching maximum leaching rates. The final criteria, if met, allow leaching rates to be calculated by equations that are based on leaching from a semi-infinite medium.

Figure 5-4 illustrates potential relationships between cumulative fraction leached, F , and time of leaching \sqrt{T} . Curve A shows a nonlinear relationship between F and \sqrt{T} for a very soluble constituent. Curve B is a straight line with a Y-intercept ($F > 0$ at $T = 0$), which indicates that the contaminant was leached in the initial rinse (surface wash-off). Curve C is a straight

Figure 5-4. Schematic plot of cumulative fraction leached vs. the square root of time.

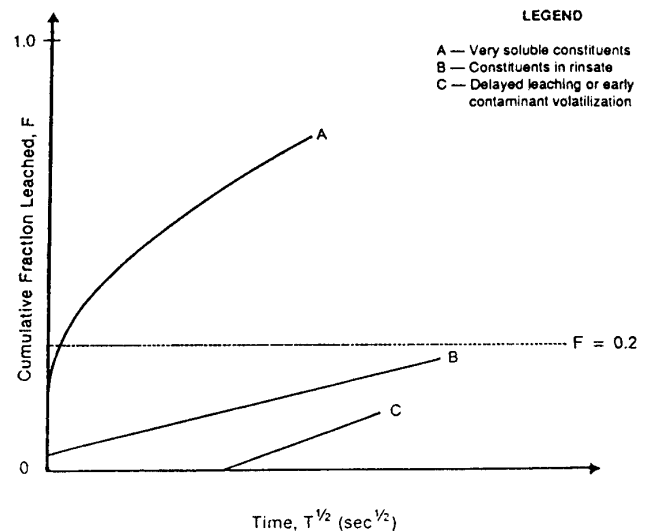

line with an X-intercept ($F = 0$ at $T > 0$), which indicates either delayed leaching or early volatilization of the contaminant from the surface of the waste form (Cote and Hamilton 1984).

Results from dynamic leach tests conducted on cement containing heavy metals with different initial concentrations and under different renewal schedules show that calculated De 's varied within one order of magnitude (i.e., LX values varied within 1 unit) (Cote and Hamilton 1986). Studies on various waste types and various leaching solution stabilizers show that organic compounds tend to have LX values between 5 and 10 (higher leach rates), and metals tend to have higher LX values (slower leach rates) (Cote and Hamilton 1986; Stegmann, Cote, and Hannak 1988). Variability in test results for metals generally are attributable to analytical sensitivity, especially for relatively insoluble metals.

5.3 Experimental Factors Affecting Results and Interpretation

Results of both leaching and extraction tests vary, primarily because of sample nonhomogeneity. Curing time may also affect leach test results. The Corps of Engineers cures waste for 28 days, as opposed to the minimum curing time of 42 days recommended by

Bishop (1988). The relative standard deviations (%RSD) reported for TCLP, EP Tox and MCC-1P range from 10 to 100 percent (ANS 1986; Newcomer, Blackburn, and Kimmell 1986; Stegmann, Cote, and Hannak 1988). Numerous studies comparing the test results obtained by TCLP and EP Tox for their relative precision (summarized in Newcomer, Blackburn, and Kimmell 1986) show that, although neither is a precise test, TCLP is as precise or slightly more precise than EP Tox in inter- and intralaboratory tests with metal wastes. Because of the variability in leaching test results, more than one sample of stabilized/solidified hazardous waste should be leach-tested.

Other experimental parameters may also affect results of batch extraction tests (Cote and Constable, 1982; Newcomer, Blackburn, and Kimmell 1986). For TCLP, varying the acidity of the No. 2 leaching solution from 190 to 210 meq greatly influences test results for metals; other variables, such as liquid-to-solid ratio (19:1 and 21:1), extraction time (16 vs. 18 hours), and filter type, have relatively little impact on test results (Newcomer, Blackburn, and Kimmell 1986).

Cote and Constable (1982) conclude that rotary-tumbler agitators used in extraction tests yield better precision than shaker tables or wrist-arm agitators. In comparing results of several different extraction tests, Cote and Constable (1982) concluded that, of five test variables (leaching medium, liquid:solid ratio, number of extractions, particle size, and period of Figure 5-4 extraction), the first three have the greatest impact on extraction test results for metals. In general, cumulative mass fractions of metals leached are higher with more acidic leaching solutions, with larger liquid:solid ratios (with neutral solutions), or with multiple extractions (Cote and Constable 1982; Cote, Constable, and Moreira 1987). In theory, particle size and period of extraction have no effect on leachate concentrations if the extraction tests reach equilibrium conditions. Studies by Bishop (1986), however, show that although the opposite is observed initially, with multiple extractions, smaller particle sizes leach slightly more metals than do larger particles.

The effects of the liquid:solid ratio vary with the type of leaching solution and the solubility of the contaminant (Cote, Constable, and Moreira 1987). With neutral or slightly acidic leaching solutions and soluble waste species, an increase in the liquid:solid ratio increases the cumulative mass fraction leached, but the leachate concentrations remains constant (i.e., the ratio of mass leached to leaching solution volume remains the same). Leachate concentrations of insoluble species in the same medium decreased with increasing liquid:solid ratio. With more acidic leaching solutions, the leachate concentrations are controlled by the pH and chemistry of the leaching solution; therefore,

leachate concentrations are not so easily predicted. In general, liquid:solid ratios must be large enough for analysis and small enough to allow detection of analytes above detection limits.

The impacts of these experimental parameters must be considered in an evaluation of the results of several leaching tests on a stabilized/solidified waste. Also, the pH and chemistry of the leaching solution must be monitored before and after the leaching test. For example, leaching tests on stabilized/ solidified metal wastes should include at least measuring the pH and alkalinity as well as total dissolved solids or conductivity of the leaching solution. Leaching tests conducted by Bishop (1988) include analysis for calcium, iron, aluminum, and other cement elements. These analyses aid in the interpretation of the leaching test data.

Other analytical techniques used to determine the speciation of waste constituents, particularly organic compounds, in the stabilized matrix are polarized light microscopy, energy-dispersive X-ray diffraction (EDX), scanning electron microscope (SEM), and electron probe microanalysis (EPMA) (Tittlebaum et al. 1987; Campbell et al. 1987). In addition, protocols for evaluating bonding between organic compounds and stabilizer in a stabilized/solidified waste have been developed by Dr. J. Soundararajan (PRC 1988). These protocols include four technologies: 1) Fourier transform infrared spectroscopy (FTIR); 2) thermal gravimetric analysis (TGA); 3) differential scanning calorimetry (DSC), and 4) DSC coupled with gas chromatography/mass spectroscopy (GC/MS).

5.4 Leaching Test Selection and Interpretation

As mentioned in the preceding discussions, leaching tests produce results that are not directly applicable to leaching behavior in the field. Nevertheless, the results of several leaching tests or of leaching tests combined with physical tests or microscopic techniques can be used as indicators of field performance and environmental impact.

When used for comparative purposes, results from several leaching tests can help to identify field conditions that result in higher concentrations of waste constituents. Therefore, these data may be used to site or design waste facilities that will minimize the leaching of hazardous constituents from the wastes. The data also may be used to predict the leaching of stabilized/solidified wastes at different stages in time. For example, leaching conditions of a well-managed operational facility where the monolithic stabilized/solidified waste receives maximum precipitation infiltration may be simulated by the use of the DLT, as this test involves constant renewal of the leaching

solution and a monolithic waste form. For a closed facility that has a cover which is maintained (i.e., a 30-year post-closure period) and minimizes precipitation infiltration, leaching conditions may be similar to those of the MCC-1P test (i.e., static hydraulic conditions). In the long run, the liners, cover, and waste form will degrade, and leaching conditions may be similar to those found in multiple extraction tests (such as MEP and MWEP) or equilibrium tests (such as ELT).

In the few cases where the actual field leaching solution is well known, use of this solution in the laboratory tests may yield more representative results. When the site leaching solution is used, however, the results may only be relevant to field leaching conditions in the short term because the site hydrogeochemistry will change over the long run.

Section 6

Technology Screening

Technology screening is a tool used to organize relevant information for each hazardous waste site for the purpose of evaluating the applicability of stabilization/solidification. Such screening is required because of the imprecise nature of stabilization/solidification and because most wastes are far from homogeneous. This section outlines a series of steps for assembling information about stabilization/solidification. An understanding of the site and its waste, bench-test evaluations of the stabilized/solidified waste form through the tests described in Sections 4 and 5, and an understanding of the implementation and costs of stabilization/solidification will aid in making an informed judgment about product suitability. The choice of a final waste product will inevitably reflect a compromise based on chemical, physical, and cost considerations. This section does not discuss design considerations in the screening of stabilization/solidification technologies; rather, it discusses the feasibility of the technologies.

Selection of a stabilization/solidification treatment technology for hazardous waste site remediation depends on the nature of the waste, the physical containment properties required for the stabilized/solidified material, the applicability of the technology to the waste site, and cost (Wiles, undated). This technology may become increasingly sophisticated as a result of changing regulations, which require a controlled product with specific leachate characteristics (Federal Register 1988). Durability tests such as those described in Section 4 are also an important aspect of evaluating the stabilized/solidified product (Jones 1986).

Waste/binder incompatibility also presents a complication in the application of stabilization/solidification technology to hazardous wastes. Experience in the cement, asphalt, and nuclear waste industries demonstrates that small amounts of some compounds can significantly reduce the physical strength and containment characteristics of the waste/binder product (Jones 1986). Some of these interactions have been documented in stabilization/solidification case studies (Jones 1986; Tittlebaum and Seals 1985; Kyles, Malinowski, and Stanczyk 1987; JACA 1985; U.S. EPA 1988d). As of this writing, however, few data quantifying the effects of interfering compounds on a particular stabilization/solidification process are available (Jones 1986; Tittlebaum and Seals 1985). Protocols for processing hazardous waste materials by use of stabilization/

solidification technologies have not been standardized.

6.1 Application of Technology Screening

Technology screening is a process in which both the limitations and applicability of a technology are systematically reviewed. With regard to stabilization/solidification, the technology screening process involves the following:

- Review of existing chemical and physical interferences between the waste and binder.
- Identification of previous studies of similar wastes.
- Identification of potential pretreatment options for the waste or the site that would extend the application of stabilization/solidification or improve the containment properties of the product.
- Assessment of site conditions that could affect the stabilization/solidification of the waste or its ultimate disposal.
- Review of health and safety and process requirements.
- Deciding on the selection of a technology based on waste disposal requirements and overall costs.

Available technical information on interferences and applications of stabilization/solidification technologies to hazardous waste materials is often incomplete and sometimes conflicting. Table 6-1 presents a listing of interferences and applications of stabilization/solidification technologies for common hazardous waste materials. The information in this table should be viewed as a starting point, as stabilization/solidification has been applied to many wastes with varying contaminants and concentrations. Because of possible exceptions to the information presented, each waste should be evaluated individually.

Selection of a technology is often complicated by gaps in documented waste/binder interferences. Selection can be further complicated by site-specific conditions and disposal requirements. The technology screening methodology uses empirical data and

Table 6-1. Effect of waste components on stabilization/solidification.

Waste component	Cement-based	Pozzolan-based	Thermoplastic	Organic polymer
<p>Organics</p> <p>Nonpolar as: oil and grease, aromatic hydrocarbons, halogenated hydrocarbons, PCBs</p> <p>Polar as: alcohols, phenols, organic acids, glycols</p>	<p>May impede setting. Decreases durability over a long time period. Volatiles may escape upon mixing. Demonstrated effectiveness under certain conditions.^a</p> <p>Phenol will significantly retard setting and will decrease durability in the short run. Decreases durability over a long time period.^e</p>	<p>May impede setting. Decreases durability over a long time period. Volatiles may escape upon mixing. Demonstrated effectiveness under certain conditions.^b</p> <p>Phenol will significantly retard setting and will decrease durability in the short run. Alcohols may retard setting. Decreases durability over a long time period.</p>	<p>Organics may vaporize upon heating. Demonstrated effectiveness under certain conditions.^c</p> <p>Organics may vaporize upon heating.</p>	<p>May impede setting. Demonstrated effectiveness under certain conditions.^d</p> <p>No significant effect on setting.</p>
<p>Acids as: hydrochloric acid, hydrofluoric acid</p>	<p>No significant effect on setting. Cement will neutralize acids. Types II and IV portland cement demonstrate better durability characteristics than Type I. Demonstrated effectiveness.^{f,g}</p> <p>Compatible</p>	<p>No significant effect on setting. Compatible, will neutralize acids. Demonstrated effectiveness.^{f,g}</p> <p>Compatible</p>	<p>Can be neutralized before incorporation.</p> <p>Can be neutralized before incorporation. Ureaformaldehyde demonstrated to be effective.ⁱ</p>	<p>Can be neutralized before incorporation. Ureaformaldehyde demonstrated to be effective.ⁱ</p>
<p>Oxidizers as: sodium hypochlorite, potassium permanganate, nitric acid, potassium dichromate</p>	<p>Compatible</p>	<p>Compatible</p>	<p>May cause matrix breakdown, fire.</p>	<p>May cause matrix breakdown, fire.</p>

(continued)

Table 6-1. (continued)

Waste component	Cement-based	Pozzolan-based	Thermoplastic	Organic polymer
Salts as: sulfates, halides, nitrates, cyanides	Increase setting times. Decrease durability. Sulfates may retard setting and cause spalling unless special cement is used. Sulfates accelerate other reactions.	Halides are easily leached and retard setting. Halides may retard setting, most are easily leached. Sulfates can retard or accelerate reactions.	Sulfates and halides may dehydrate and rehydrate, causing splitting.	Compatible ^h
Heavy metals as: lead, chromium, cadmium, arsenic, mercury	Compatible. Can increase set time. Demonstrated effectiveness under certain conditions. ⁱ	Compatible. Demonstrated effectiveness on certain species (lead, cadmium, chromium). ^{d,j}	Compatible. Demonstrated effectiveness on certain species (copper, arsenic, chromium). ^g	Compatible. Demonstrated effectiveness with arsenic. ^d
Radioactive materials	Compatible	Compatible	Compatible	Compatible

a Tittlebaum and Seals 1985; Van Keuren et al. 1987; JACA 1985; USEPA 1986; Jones 1986.

b Musser and Smith 1984; USEPA 1984; Kyles, Malinowski, and Stanczyk 1987; Tittlebaum and Seals 1985.

c Tittlebaum and Seals 1985; JACA 1985.

d Tittlebaum and Seals 1985.

e Kolvites and Bishop 1987.

f JACA 1985.

g Van Keuren et al. 1987.

h Musser and Smith 1984.

i Federal Register 1988; Kyles, Malinowski, and Stanczyk 1987.

j USEPA 1984.

experience when such are available and addresses site- and waste-specific concerns as they apply to a certain stabilization/solidification technology. Thus, limitations and applications of a technology are pre-viewed before large amounts of resources are committed to a site. The cost of hazardous waste treatment and disposal depends on several binder-, waste-, and site-specific conditions.

Site and waste modifications that aid or enhance stabilization/solidification methods should be considered. Specifically, binder additives can be used to reduce the negative effects of organic waste constituents (especially oils, greases, and solvents) on the stability of stabilized/solidified materials. Many of these additives are proprietary or experimental, and little direct information is usually available. In some cases, the wastes should be pretreated to increase their acceptability for stabilization/solidification. Examples of pretreatment technologies that have been used at hazardous waste sites and might be applicable to stabilization/solidification are neutralization, precipitation, adsorption, and chemical oxidation (JACA 1985; USEPA 1986; U.S. EPA 1988d). Site modifications (e.g., water table diversion or depression) may be able to be practiced at some stabilization/solidification sites. An important modification, which relates less to chemical properties than to physical properties, is mixing. Simply mixing a stratified lagoon, for example, can make processing more effective because it generates a uniform or constant material. This reduces the chance of errors related to process change. How frequently these site modification techniques are used is difficult to determine, but success stories have been reported (U.S. EPA 1988d).

As a result of site-specific conditions, different types of hazardous wastes, and increasing land disposal restrictions, a complete site characterization is needed for selection of an appropriate treatment regime for a particular site. In some cases, specific waste/binder incompatibilities will rule out a particular stabilization/solidification technology. Comparisons of various stabilization/solidification technologies with competing remediation measures such as soil washing are not straightforward. Selection of the proper remediation measure often is a compromise based on both engineering and scientific characteristics.

Figure 6-1 presents a technology screening flow chart that can be used to develop a treatment plan for a given waste site. As shown, this screening approach consists of five distinct phases, which may overlap or run concurrently:

- 1) *Waste Screening.* Obvious characteristics, such as the presence of large quantities of water or regulated materials, require the waste be pretreated to make it acceptable for stabilization/solidification.

- 2) *Waste Characterization.* The waste is analyzed for constituent compounds and the presence of inhibitors is established.
- 3) *Bench-Scale Testing.* Trial stabilized/solidified waste forms are created and tested by chemical and physical means to determine the proper agent type and quantity.
- 4) *Site Evaluation.* The applicability of the process to the particular site is reviewed. For example, the presence of a near-surface water table may require the ground water to be lowered for stabilization/solidification to proceed.
- 5) *Cost Evaluation.* A determination must be made as to whether stabilization/solidification can be implemented economically.

6.1.1 Waste Screening

The initial screening step entails identification of waste characteristics that may preclude the use of a technology. It may show that the complex hazardous waste contains a regulated constituent that cannot be landfilled (e.g., dioxin) or that the organic levels in the waste are in excess of vendor or literature specifications for successful stabilization/solidification. In some cases, engineering solutions may be available to overcome these initial problems.

The presence of oil or grease in the waste material slows (or sometimes stops) the setting and curing reactions of cementitious and pozzolanic stabilization/solidification. Vendors and empirical studies show conflicting results as to the amount of oil and grease that can be isolated within the solid inorganic product matrix without creating short- or long-term leachate or matrix problems. In low concentrations, oil and grease entrapment appears to take place and the matrix does not seem to be affected (Tittlebaum and Seals 1985; Rowe and API 1987). Some vendors indicate up to 25 percent oil and grease, by weight, can be accommodated by cement and silicate mixtures or pozzolanic mixtures without inhibiting the stabilization/solidification reactions (JACA 1985). Other studies (Kyles, Malinowski, and Stanczyk 1987) and vendors indicate success with lower or higher concentrations of oil and grease with their treatments. Depending on the oil and grease content of the material and its physical state, phase separators (oil/water separators, centrifuges, dissolved air flotation) or in situ biodegradation may be appropriate for removing excess amounts of oily material that are not easily treated by these inorganic stabilization/solidification technologies. The characteristic limitations and costs of each pretreatment technology will need to be identified before further consideration can be given to implementation. Bench-scale study will normally be required to confirm the response of the waste to pretreatment

Figure 6-1. Technology screening flowchart for stabilization/solidification.

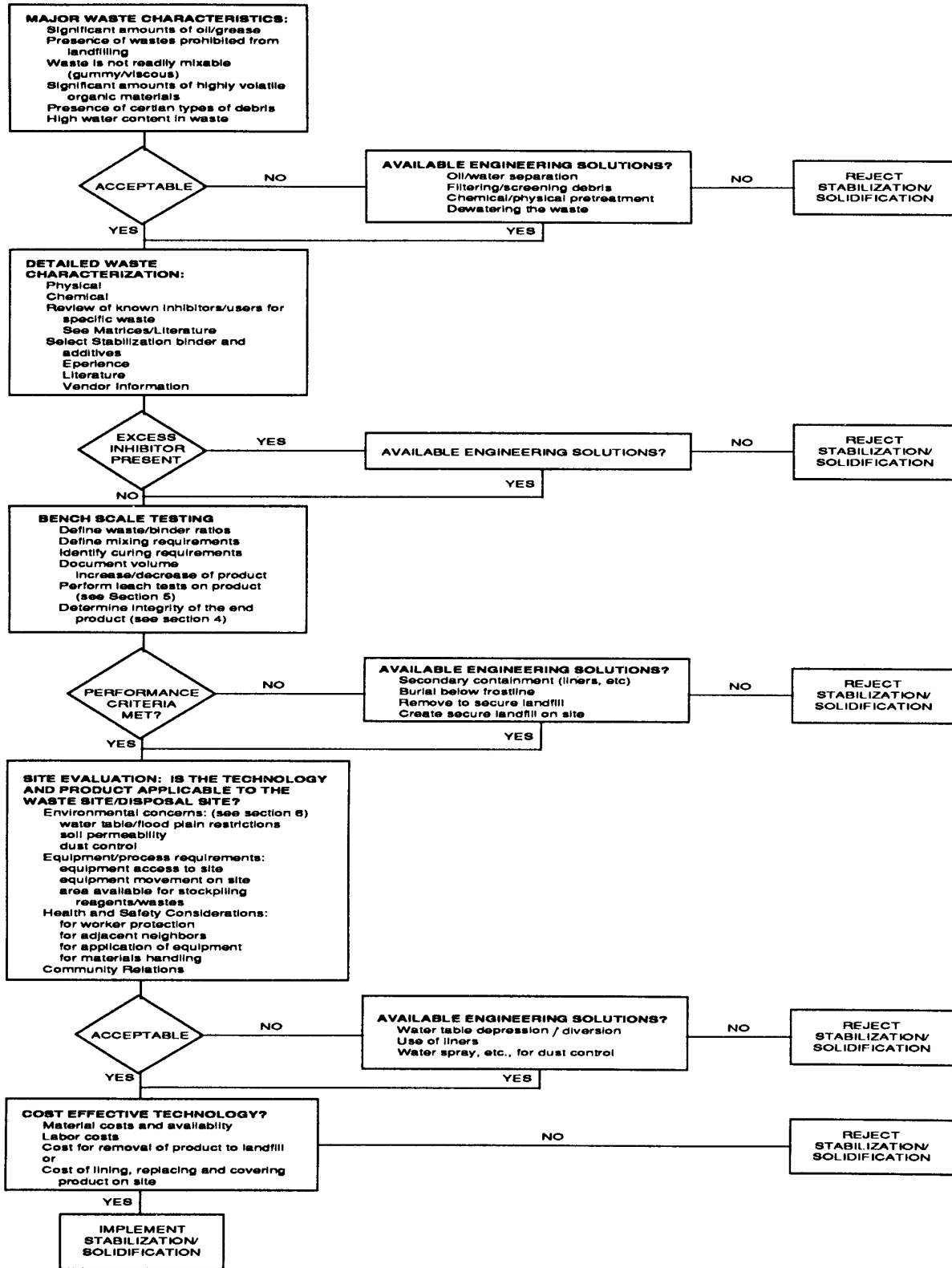

and to stabilization/solidification. Although interference from oil and grease is less of a problem when organic binders are used, the stabilization/solidification process will nevertheless vary with the type of organic binder and the level of oil and grease in the waste.

The capability of inorganic and organic binders to treat organic materials (e.g., pesticides, PCBs, and solvents) is a somewhat controversial issue in the hazardous waste literature. Organic chemicals can act as solvents for some organic binders (Tittlebaum and Seals 1985), and phenol or organic solvents can inhibit the setting and curing reactions of inorganic binders (JACA 1985). Different types of organics will affect the final product in various ways (Tittlebaum and Seals 1985; Kolvites and Bishop 1987), and the effect of the interfering material is usually disproportionate to the amount present in the waste (Jones 1986). Therefore, waste assessment must include individual chemical constituents and classes of organics rather than rely on total organic content of the waste material. Current literature (U.S. EPA 1986h) and vendor information often summarizes total organic concentrations, which are reported as being treatable with inorganic binders. One common range reported is 20 to 40 percent (U.S. EPA 1986h). This information cannot be directly applied to all classes of organic chemicals, however. It may be possible and cost-effective to treat or remove the interfering organic material or to modify the binder/additive mixture to achieve successful stabilization/solidification (Tittlebaum and Seals 1985; U.S. EPA 1986h). Depending on the type of organics present, several options are available for removal of a large fraction of the organic material or for controlling the effects of organic materials on the inorganic stabilization/solidification. These include:

- Soil washing
- Thermal removal
- Chemical oxidation
- Extraction removal
- Biodegradation
- Addition of adsorbent prior to mixing (limestone, diatomaceous clays, activated carbon, or fly ash)

For cement-based and pozzolanic processing, small concentrations of volatile organic carbons may be trapped within the inorganic matrix (Tittlebaum and Seals 1985); however, volatilization may occur during excavation, mixing, or curing because of the agitation and heat of hydration (Weitzman, Hamel, and Barth 1988). Air quality standards or health and safety precautions may require the control of volatile organics during processing. In addition, many organic binder technologies require preheating of the binder and waste as part of processing. For waste constituents that decompose or volatilize at the temperatures required for organic stabilization/solidification processes,

the use of these processes may be precluded. Process modifications (e.g., batch mixing with volatile off-gas scrubbing) may help to resolve this problem. When scrubbing is impractical, pretreatment to remove volatile organic carbon may be warranted.

Occasionally, the consistency of the waste may prevent mixing. For example, creosote wastes may be too viscous for easy excavation and mixing. Heating the material to reduce the viscosity and to improve mixing potential can result in noxious organic vapors. Excavation during the winter freeze is possible, but the wastes must be heated before they are mixed with the binder. Many organic binders are somewhat difficult to mix because of their viscous nature. Mixing problems can arise when materials having significantly different viscosities are combined.

When the wastes are very dilute, dewatering technologies may prove useful as a pretreatment method. Depending on the characteristics of the waste material, filtration (vacuum, belt filter press, chamber pressure filtration) or membrane separation may make stabilization/solidification treatment more feasible. Water may be required for the hydration of both cement- and pozzolan-based stabilization/solidification, however. Excess water is a liability for both organic and thermal binder technologies because it increases the cost of processing. In both cases, the water must be vaporized before or during processing, which requires more energy and thus greater cost. If a dewatering technology is used to remove excess water, the supernatant must be assessed for possible contamination and treatment prior to its disposal.

Removal of debris can be important for equipment protection and for process quality control. Documented cases of mixer or conveyor belt damage and problems with binder encapsulation of large articles of debris point up the need for this aspect of waste characterization (U.S. EPA 1988d). Debris can include common items such as tires and tree stumps that are buried with other hazardous waste. The physical separation and washing of these materials may be both feasible and economical. When debris is included with the waste material, processing difficulties may occur in the mixing and conveyer equipment. Debris can also interfere with quality control of the final product in all of the stabilization/solidification technologies.

6.1.2 Waste Characterization

Hazardous wastes are characterized through analysis of major physical and chemical properties. At this level of scrutiny, possible inhibitors are reviewed and binders, additives, and appropriate pretreatment options are chosen. Stabilization/solidification experience, vendor information, and literature reviews can serve as bases for the selection of the proper stabilization/solidification system, plausible waste/binder

ratios, and other options. In some cases, waste pre-treatment may be required to overcome specific waste problems.

Interferences from waste constituents can affect the physical properties of inorganic and organic binder/waste products. With regard to the inorganic binders, these constituents may interfere with the setting reactions, the water-to-binder ratio, the porosity, or the final strength of the product (Jones 1986). Interfering constituents may soften organic binders or require larger amounts of binder to overcome their negative effects. In addition, inhibitors exhibit various time-related effects. With regard to organic binders, some materials can slowly deteriorate the organic binder/waste product or prevent stabilization/solidification from occurring. Surface-active molecules work on the cement (or pozzolan) and water immediately. Set-controlling materials ionize and affect the chemical reaction between the cement (or pozzolan) and water after minutes or hours. Finely ground insoluble minerals affect the rheological behavior of fresh cement, but the chemical effects take several days or months to become manifested (Jones 1986). The following are examples of the physical manifestations that can occur when interfering constituents are present in the hazardous waste and stabilization/solidification is attempted with inorganic binders:

- Spalling and cracking
- Set retardation; hardening and waste containment are impeded.
- Flash set; mixing of binder and waste is incomplete as a result of a very quick set; equipment can be fouled.
- Chelated/complexed toxic constituents may accelerate leaching, even if the waste is successfully stabilized/solidified.
- Some waste constituents can react and cause swelling and disintegration of the stabilized/solidified mass long after setting reactions are complete (Jones 1986).

Oxidizing salts can cause slow deterioration of the organic binder matrix (Tittlebaum and Seals 1985). Large quantities of sulfur, calcium chloride, sodium arsenate, sodium borate, sodium phosphate, sodium iodate, sodium sulfide, as well as the soluble salts of magnesium, tin, zinc, copper, and lead all adversely affect inorganic binders (JACA 1985; U.S. EPA 1986h). Salts can often cause swelling and cracking within the inorganic matrix, which exposes more surface area to leaching. These effects can occur in the short term or the long term.

In addition to the specific chemical interferences listed in Table 6-1, other chemical factors have an impact on waste/binder compatibility. An alkaline pH is required for most inorganic binders to set and cure properly. In the high-pH environment generated with

inorganic binders, amines or aminated compounds evolve as ammonia. In high concentrations, gaseous ammonia can cause immediate danger to life and health. Any environmental or waste condition that lowers the pH of the inorganic (e.g., lime, cement) crystalline matrix will eventually cause matrix deterioration. Flocculants such as ferric chloride can interfere with the setting of cements and pozzolans (JACA 1985). Phenols and nitrates cannot be immobilized with lime/fly ash, cement, and soluble silicates; fly ash and cement; or bentonite and cement (Stegmann, Cote, and Hannak 1988).

On hazardous waste sites, concentrations of the waste components usually vary with location and depth. Solid waste dumps and lagoons are often stratified or pocketed with varying waste materials. Records of the historic deposition of these wastes can reveal the types of materials that may be encountered at different levels or in different cells within a site.

Physical properties of the waste, such as volume, solids content, particle size distribution, water content, debris content, viscosity, and pH have an impact on waste processing. The volume, solids content, and particle size analysis aid in determining the waste-to-binder ratio. Moisture content is also important in determining whether water should be added or removed for processing.

6.1.3 Feasibility Testing

No set protocol has been established for determining the feasibility of stabilization/solidification at the bench-scale level. Testing addresses the leaching potential of the stabilized/solidified waste as well as its durability.

During bench-scale testing, different waste-to-binder ratios are used to stabilize/solidify waste samples. Selection of the optimum waste-to-binder ratio is usually based on leach-test and durability-test results. The desired properties of the stabilized/solidified product may vary with the geographic region and type of final disposal site. For example, EP Toxicity, unconfined compressive strength, wet-dry, and freeze-thaw tests may be among those required of a stabilized/solidified product at a given site. Incompatibilities in product quality may be resolved on a site-specific basis. For example, if the optimum EP Toxicity results are obtained with a stabilized/solidified waste that erodes readily during freeze-thaw testing, the solution may be to bury the waste below the frostline. Bench-scale tests can define process control requirements, including mixing requirements, curing time, and quality control parameters, which can then be further defined during pilot-scale testing. Defining these parameters is important and could save time and money during field operations. The processing specification is often recognized to be as important as the product specification.

Determining whether the volume of the stabilized/solidified product will increase or decrease is an important parameter, both for onsite and offsite disposal. At some remediation sites, the excavated original raw waste must be replaced with stabilized/solidified waste material. If the treatment results in a large increase in the volume of the stabilized/solidified product, some of it may have to be removed from the site or the waste volume must be reduced prior to stabilization/solidification treatment. When the waste product is transported to an approved landfill, an increase in its volume adds to the overall cost of remediation.

Whenever possible, waste materials from the actual waste site should be used for bench-scale testing. Differences in the physical and chemical characteristics of the actual waste (such as particle size distribution and complex chemical constituents) can affect waste/binder relationships and final product characteristics.

Bench-scale studies offer a significant advantage in the refinement of the overall system design, including the establishment of a quality control (QC) program. Bench-scale test mixtures can be used to verify or supplement the waste/additive design and provide both visual and numeric observations for establishing QC criteria.

During testing, the following information is important for an evaluation of inorganic and organic binder technologies:

- Leaching tests appropriate for the waste site.
- Durability tests as appropriate for the final disposition of the product (e.g., freeze-thaw testing has little relevance for a material that will be buried beneath the freeze line or that is in a part of the country where it does not freeze).
- Permeability tests of the final product, which should be two orders of magnitude below that of the surrounding materials.
- The waste-to-binder ratio needed to achieve leaching and durability characteristics appropriate for the waste site.
- Increase or decrease in the volume of the final product.
- Evolution of gases during processing, curing, or preprocess drying.
- The need for dewatering or adding water to the inorganic waste/binder mixture.
- Ability to mix the waste material and binder.

6.1.4 Site Evaluation

The fourth evaluation step involves a review of relevant environmental conditions that may affect waste containment on the site, during both excavation and processing. Environmental parameters that should be considered include the depth to the water table; location of any sensitive environmental conditions within the study site; access to the site for equipment and material; processing space requirements; health and safety issues; and planning for potential community relations. Standard construction practices can be evaluated for such site modifications as water table depression/diversion or access road construction. Final disposal options are reviewed and confirmed during this phase. These options may include the construction of a liner on the site or offsite transportation and disposal. The availability of adequate soil for capping and lining the waste site also can be determined during this phase. Where applicable, the site evaluation should also include information on the placement and construction of monitoring wells.

Overall site-specific concerns with regard to a remedial action project are geared toward evaluating waste containment potential. Containment depends in part on the types of wastes, their characteristics, and their physical state. The proximity of a waste to the water table, onsite drainage tiles, or receiving streams offer significant migration potential before, during, and after onsite disposal of the waste material. Important site parameters in this regard include:

- Area of the site
- Permeability of the area soils, both for a review of leaching capabilities and also for possible liner/cap material
- Existing ground-water contamination
- Velocity and direction of both ground water and ambient air
- Site drainage
- Proximity to populated areas
- Access routes to the site
- Available work area/stockpiling area on the site
- Final disposal options and their site-specific implications
- Postremediation use of the site
- Sensitive environmental areas within the work site, such as flood plains or marshes.

* This discussion applies primarily to processes in which materials are excavated, processed on site, and returned to the excavated area. In situ processes do not require excavation and replacement of stabilized/solidified materials. This advantage could lead to the selection of an in situ process. Offsetting this advantage may be limitations due to poor mixing or depth. Section 7.1.8 describes these in situ processes. Other factors, e.g., the presence of a near-surface water table, relate to all stabilization/solidification processes.

- Waste product volume increase and its implications for the capacity of the site to contain final product if onsite disposal is required.
- Dusting and material stockpiling
- Ability to mix the materials adequately on the site
- Availability of the binder/additives in the amounts required for the entire site.

Access to the waste site for appropriate equipment for excavating and processing the waste materials should be evaluated on a site-by-site basis. Numerous standard construction practices provide solutions to the problem of difficult access. Sometimes, special roads must be built or existing roads modified to accommodate the needs of the site. Sometimes, contractors have modified their equipment to gain access. Such modifications add to the overall cost of the project, and customized equipment may be difficult to repair because of the unavailability of standard replacement parts.

In some cases, the waste site cannot provide sufficient area for the expected processing, binder stockpiling, and temporary or final waste disposal. Some kinds of processing require stockpiling of untreated excavated wastes, the processed wastes, and the binder, and these materials may have to be covered to reduce exposure to the elements. Binders increase the volume of the waste product, and this added volume could present difficulties where the waste/binder product is buried in the original waste site excavation. Solutions to problems posed by limited area must be developed on a site-specific basis. Delivery of preweighed amounts of the binder directly to the process site is one possible solution. The binder can then be added directly to the in-place mixing area rather than being stockpiled in bulk containers.

The presence of a water table in the waste area creates three problems: 1) a water table poses the possibility of existing ground-water contamination; 2) excess water (especially flowing water) can cause excavation difficulties; and 3) a water table creates the potential need for dewatering a saturated waste material prior to its processing. All three of these problems have significant cost implications and must be resolved before the final technology selection is made.

Some waste materials are difficult to excavate and handle. Waste pretreatment can consist of adding sorbents or inorganic binder to dewater the waste and to increase its handling ability before it is processed with different inorganic or organic binders. This adds both a cost factor and a volume factor to the overall operation. For selected wastes, excavation in the

winter or summer will alter the consistency of the material sufficiently to allow its excavation.

Site environmental effects also can be critical. Seasonal timing to remove wastes while they have the most suitable viscosity level was discussed in Section 6.1.1. Freezing retards the overall reaction rate and may cause long-term damage of the matrix. Summer temperatures in excess of 100°F accelerate the reaction rate and may ruin the final product.

6.1.5 Cost Evaluation

In the fifth phase, an assessment is made of the costs involved with the entire technology as it will be applied to the waste and final disposal site. This includes the cost of binders, additives, pretreatment, excavation and moving equipment, labor, and final disposal of the waste. Disposal costs may include preparation for onsite burial (liners, caps, and possibly monitoring wells) or transportation and dumping fees for offsite disposal.

6.2 Summary

Choosing a waste disposal method is a complex decision. The costs, capabilities, and limitations of different technologies and their application to both the waste site and waste material must be weighed. Technology screening provides a systematic methodology for reviewing the most important elements of the waste material, the site, and the technology.

Few adequately documented studies exist that report the long-term performance of stabilized/solidified hazardous wastes. Performance in this context is determined by the physical and chemical stability of the waste/binder product and related leaching characteristics. Also, almost no published information is available on the nature, strength, and permanence of the bonds formed in the stabilization/solidification process. Some data have been compiled from the experience of the construction and nuclear waste treatment industries. These admixtures are managed in the construction trade by means of strict limitations on the amounts of additives allowed for a particular application. In addition, batch testing of a product is an integral part of the total construction project. During the screening of stabilization/solidification technologies for their adequacy for isolating toxic constituents and improving the handling characteristics of hazardous waste materials, a review of known inhibitors is recommended. The list of inhibitors is incomplete, however, and even the effects of a single component additive are still poorly understood. Interfering reactions with mixed or complex wastes cannot be predicted (Jones 1986; JACA 1985).

As long as this information is lacking, the practice of designing stabilization/solidification schemes for hazardous wastes will continue to be primarily empirical in nature. Such design practices are also likely to be based on the short-term performance of the stabilized/solidified product (Jones 1986).

Section 7

Field Activities

This section covers the application of the stabilization/solidification process at a site. It includes a discussion of stabilization/solidification functions and processes, lime stabilization techniques, and site conditions that can affect the stabilization/solidification process.

Many of the tests described in Sections 4 and 5 often relate to stabilized/solidified forms developed in the laboratory. Whereas these stabilized/solidified test forms may have excellent waste characteristics, duplicating these forms under field conditions can be difficult because of the equipment used for field stabilization/solidification and the conditions present at the site. Also, the volume of the materials to be stabilized/solidified at a site often reaches thousands of cubic yards. Equipment is usually geared to the characteristics of the site and its materials. For example, at many sites the material to be stabilized/solidified is in abandoned impoundments, and its removal may require large-scale earth-moving equipment such as tracked backhoes or draglines. At other sites, the soil itself needs to be stabilized/solidified, and equipment such as loaders and bulldozers is used to move this soil.

Regardless of the process chosen, adequate quality assurance/quality control (QA/QC) procedures should be implemented to be certain the material produced is near the desired composition. This seemingly simple task is difficult to accomplish and requires answers to questions such as the following: Is the material to be judged as it is produced? How much time is required to test the quality of the material? For large-scale operations in which the material could conceivably be reprocessed, the turnaround time for the QA/QC procedures must be quick so as to minimize the amount of material that must be recovered and to avoid the possibility of burying stabilized/solidified material that cannot be easily retrieved and reprocessed.

The operations described in this section frequently use earth-moving equipment. The manufacturers' literature contains descriptions of this equipment, such as the reach of backhoes, the capacity of loaders, and the associated cycle times of the equipment. The Caterpillar Performance Handbooks (Caterpillar 1987a, 1987b) are excellent sources of information for these operations. These easily understood handbooks provide information needed for estimating the costs of the basic operations required at a site.

With the exception of a few specialized processes, most hazardous waste stabilization/solidification operations fall into two categories: 1) lime/silicate-based stabilization/solidification, which results in a product similar to mortar; and 2) stabilization/solidification of a soil-like material. These two processes are quite different. One produces a material that hardens like mortar, and the process and its QA/QC procedures are comparable to those used in mortar production. The waste forms, however, differ greatly from mortar in physical characteristics and they are usually far less durable. The other process produces a material that must be described in terms of soil mechanics and soil handling.

7.1 Stabilization/Solidification Functions and Processes

Regardless of the stabilization/solidification process chosen, typically seven functions must be satisfied for its successful implementation:

- 1) Waste removal
- 2) Untreated waste transportation
- 3) Untreated waste storage
- 4) Chemical reagent storage
- 5) Waste/reagent mixing
- 6) Stabilized/solidified waste transportation
- 7) Stabilized/solidified waste replacement

In addition to the preceding, the waste may have to be stockpiled, moved, or further processed in pre-treatment operations (e.g., dewatering or neutralization). Some processes may not require all of the steps listed. An example would be in situ stabilization/solidification, in which the reagent is brought to the waste and it is then stabilized/solidified in place.

7.1.1 Waste Removal

Waste removal generally involves the use of traditional earth-moving equipment such as tracked backhoes, draglines, bulldozers, and front-end loaders. Because this equipment has been in use for many years in the construction industry, its application to hazardous waste handling is merely one of adaptation. Nevertheless, the characteristics of the waste and the site must be considered.

Waste characteristics of importance are its corrosivity, its physical state (liquid or solid), and its potential hazard. Corrosivity is important with respect to the materials of construction for the removal equipment. Most construction equipment is fabricated of steel and is subject to acid attack. This problem can be eliminated by use of a neutralization pretreatment step. Neutralization should be performed carefully. The neutralization of acidic liquids generates hydrogen, an explosive gas. Slowing down the neutralizing process can control this generation. Also, neutralization should not take place in confined spaces. A final caution—chemicals should be added sparingly to avoid the incurrence of excess costs.

The physical state of the waste also may influence the sequencing of operations necessary for the site. For example, any liquid present above the waste (supernatant) can be managed by removing it and treating it as a separate waste.

The hazard posed by the waste is of concern to the equipment operators and other workers. Complete enclosure of the operator space in construction equipment and the provision of breathing air may be essential at sites where dangerous materials such as hydrogen sulfide or cyanide may be present.

Tracked backhoes and draglines are used for the remote removal of materials. Figure 7-1 shows tracked backhoes and draglines in operation at a hazardous waste site. Typically, a backhoe is used in areas where front-end loaders and bulldozers cannot be used because of the soil's instability. Backhoe operations are possible in hazardous waste sludges that ordinarily could not support equipment. During its operation, the tracked backhoe rests on mats constructed of wooden timbers. As the operation progresses, additional mats are used or the old mats are moved. The backhoe is limited by the distance and depth it can reach and by the cycle time of the operating sequence.* Distance and depth are available from the equipment manufacturer's manuals (Caterpillar 1987a, 1987b). Because these vary by machine size, the size of the site and the required reach of the backhoe determine the piece of equipment to be used.

The cycle time of the operating sequence depends on the operator, the material to be removed, the removal equipment, and the transportation equipment (e.g., dump trucks). An efficiently operated site considers all of these characteristics and their interrelation. For example, the rate at which waste is removed needs to be assessed so the proper number of dump trucks can be used at a site. The rate of material removal and transportation should be as evenly matched as possible (Caterpillar 1987a).

Draglines are applicable where reaches longer than 40 feet are necessary. They are delivered to a site in pieces, usually by truck, and assembled on site. This delivery and assembly must be considered as it may require several days. The assembly should take place before the arrival of workers whose activities are not related to its use. As shown in Figure 7-1, a dragline is a very large piece of equipment. Its size permits the removal of materials at a distance, but at the price of imprecision. Even a good dragline operator cannot assure removals more accurate than plus or minus a couple of feet in depth. Thus, excess material is usually removed during dragline operations. Although a dragline is often used to remove materials entrained with liquids, such removal is not efficient because the liquids escape from the bucket. Other considerations required in connection with the use of a dragline are similar to those for a tracked backhoe.

In contrast to backhoe operation, bulldozers and front-end loaders maneuver in and on the material that is being removed. The bulldozer pushes the material by scraping. In a stabilization/solidification operation, this movement of material may be to an area where stabilization/solidification takes place or to an area where it is loaded. Front-end loaders are capable of both removal and loading of solid material. This capability is advantageous when the material must be placed in a dump truck or a hopper for transportation or processing. Front-end loaders can also be operated in sludge material. The use of low-pressure tires (LPT) allows the equipment to be operated in soft (but not liquid) materials.

7.1.2 Untreated Waste Transportation

Depending on the nature of the waste and the site, waste can be transported by dump truck, pump and hose, or a fixed system such as a conveyor belt or screw auger system. Dump trucks are commonly used to transport solids, particularly when the liquid content is low and travel distance is more than one-fourth mile. As with the use of a backhoe, the carrying capacity of the trucks at a site must be matched with the capacity of the removal equipment. Spillage particularly must be considered because the waste is hazardous. Truck beds should be lined with plastic to prevent escape of waste when the waste contains liquid or when the trucks will travel offsite. The trucks can also be covered with tarpaulins; this is essential when the material consists of small particles that are subject to wind dispersion. As an alternative, the material can be sprinkled with water to reduce dusting. Finally, trucks are a commonly accepted means of conveying waste material when it must be taken out of a controlled area. When this occurs, the trucks

* Presence of overhead utilities greatly restricts the use of this equipment.

Figure 7-1. Photograph of tracked backhoes and draglines in operation at a hazardous waste site.

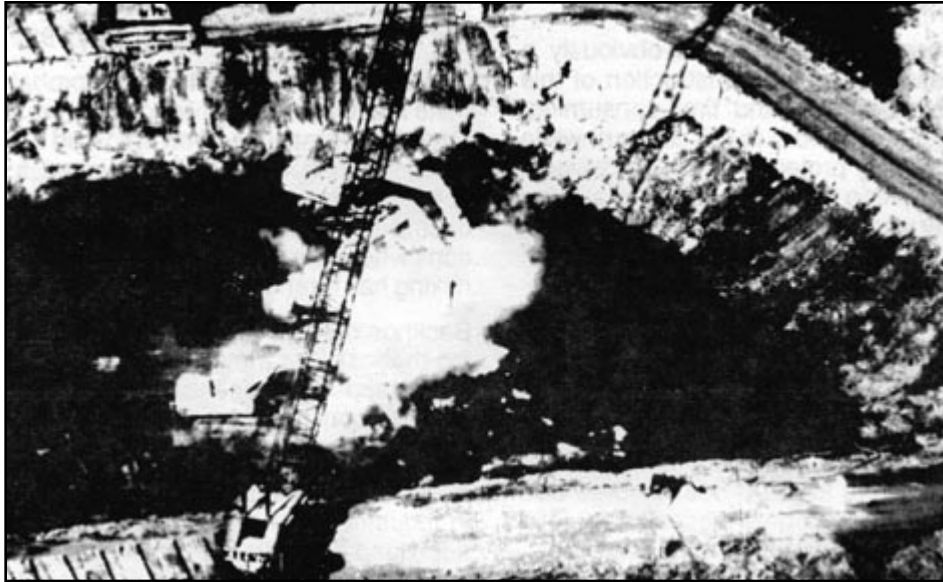

Source: Geo-Con Inc., Pittsburgh, PA.

must be thoroughly decontaminated upon exiting the site, and their beds must be decontaminated upon project completion. Decontamination usually produces large quantities of water, which in turn must be treated before its disposal.

Conveyor transportation is used at a site where large amounts of waste must be moved over a fixed distance for long periods of time. Their setup is complicated and costly, but the complexity and expense are offset by their ease of use once they are set up. Conveyors cannot move liquids, and spillage can be a problem if the material to be stabilized/solidified is not dewatered or its water decanted. Because a conveyor is a piece of moving equipment, time must be allotted for maintenance and repair. Also, the use of sidewalls may be necessary to prevent unwanted dispersal of hazardous materials.

Pumping of hazardous waste solids may be feasible if they are sludge-like in nature. In this instance the transportation function is also the removal function. The advantage of pumping is that the waste can be sent directly to the processing equipment.

Thixotropic sludges, which liquify upon movement, illustrate the need for thorough preparation (as discussed in Section 6, Technology Screening). These sludges can be transported without spillage by the use of gondola conveyors or protective displacement pumps. A special example of a pump, a sulfur pump, is equipped with a set of steam coils that melts the solid material on which it rests and enables the liquid to be pumped.

7.1.3 Untreated Waste Storage

Occasionally, untreated hazardous waste must be stored prior to stabilization/solidification. This storage should be evaluated for each individual site, but the following factors should be accounted for in any case:

- A 2 to 3 percent sloping of the storage area to provide for collection of liquids.
- Lining of the storage area with a high-density, polyethylene, flexible, membrane liner and sand to prevent contact between liquids and the soil and to allow for easy drainage of the liquids.
- Preparation of the underlying soils to remove rocks, cobbles, and vegetative matter that could puncture the liner.
- Installation of drainage pipes and a sump for final collection of liquids.
- Operation of a water-treatment system to remove hazardous constituents (from the collected liquids) and to reduce the volumes of liquids that must be stored.
- Covering of the wastes to prevent their dispersion.
- Berming of the sides of the area to resist slumping of the waste.
- Installation of a cement loading ramp for the unloading of wastes from trucks.

- Provision of a rubber-tired front-end loader to move wastes within the storage area.

Providing a temporary storage area is obviously a complex task. Inasmuch as the construction of this area can be both expensive and time-consuming, planning this aspect of the work is just as worthwhile as for other engineering projects. Untreated waste storage requirements can be minimized by matching excavation capacity with treatment capacity.

7.1.4 Chemical Reagent Storage

The satisfactory operation of a stabilization/solidification process requires some material stockpiling. Primary requirements are 1) sufficient storage of agent to prevent delays in operation; 2) ability to keep an agent dry, as virtually all stabilization/solidification agents are dry; and 3) ease of unloading upon delivery from the supplier and to the process. Bins and hoppers are the primary storage vessels for solid agents. The hoppers are sometimes transportable. On occasion, solid materials are delivered to the site in bags, which are palletted, or in bulk for storage in piles. Liquid storage is occasionally required, and chemical storage tanks are routinely used for this function.

7.1.5 Waste/Reagent Mixing

The heart of the stabilization/solidification process is the mixing of the hazardous waste and its stabilization/solidification agent. Unfortunately, this is also the area in which the process fails to meet expectations. Therefore, most QA/QC procedures are directed toward this operation.

The objective is to achieve mixing in a practical manner. Although ideally, all hazardous waste should be mixed and reacted with the stabilization/solidification agent, Tittlebaum et al. (1986) have shown that, even under ideal laboratory conditions, complete mixing is not achieved. Thus, a question of degree of mixing becomes a consideration before one piece of equipment is sent into the field.

Many of the stabilization/solidification activities that have occurred in the United States have used what is known as "area mixing." In area mixing, the stabilization/solidification agent is delivered to the area to be stabilized/solidified and mixed with the waste directly. Often, tracked backhoes, whose removal capabilities were described in Section 7.1.1, are used for the mixing. Figure 7-2 shows backhoes being used to mix sludge and lime. Typically, enough water is present in the waste to promote reaction with the stabilization/solidification agent and the waste. The waste is mixed until the operator judges the mixing to be complete. The benefits to this type of mixing are 1) the waste usually need not be removed from the site, 2) the operation requires only traditional earth-moving equip-

ment, and 3) it is inexpensive. Stabilization/solidification accomplished by backhoe mixing at Vickery, Ohio, has been well documented (Curry 1986).

Offsetting these benefits is the probability of incomplete and inadequate mixing of the waste. Virtually no QA/QC program has been enforced at many stabilization/solidification sites, and successful stabilization/solidification cannot be assured unless it can be demonstrated that proper mixing has occurred. In operations where area mixing has been used, the degree of mixing has been left to the operator's judgment.

Backhoe mixing is unlikely to result in complete mixing that assures that the waste is physically or chemically trapped. Processing equipment, such as pug mills, ribbon blenders, etc., provides more efficient mixing.

A wide range of mixing equipment is available for use in industries that process solids. This equipment is described by Cullinane, Jones, and Malone (1986) in their handbook on stabilization/solidification of hazardous wastes. Typical mixing equipment suitable for use in stabilization/solidification operations includes pug mills, ribbon blenders, Mueller mixers, extruders, and screw conveyors (Green 1984). The waste and reagent can be metered into this equipment during mixing for quality control purposes.

Some waste stabilization/solidification contractors report the use of pug mills for mixing operations. Pug mills are manufactured by several companies and are occasionally modified by contractors to suit their special needs. Pug mills consist of double screws, which allow one material to be mixed with another on a flow-through basis. The materials are generally partially mixed before they are introduced into the pug mill. Figure 7-3 is a photograph of a pug mill operation. As shown in the photo, one solid is added at the top by a screw conveyor, mixed with a second solid, and then fed to the pug mill.

Many small generators drum inorganic wastes that are not suitable for incineration. These drummed liquid wastes can be stabilized/solidified by methods discussed by Cullinane, Jones, and Malone (1986). Although drum mixing has limited application, it may provide better mixing than other methods used to add stabilization/solidification reagents to hazardous waste.

7.1.6 Stabilized/Solidified Waste Transportation

Stabilized/solidified waste is transported by the same means (dump truck, conveyor) as unstabilized/unsolidified waste. Transporting stabilized/solidified waste is usually easier than transporting untreated waste because it should be water-free and less subject to wind dispersal. One disadvantage associated with transporting stabilized/solidified waste is that it may set up (as cement does) if held too long. This can be

Figure 7-2. Photographs of backhoe mixing of sludge and lime.



Photographs courtesy National Lime Association

Figure 7-3. Photograph of a soil-bentonite mixing plant using a pug mill.

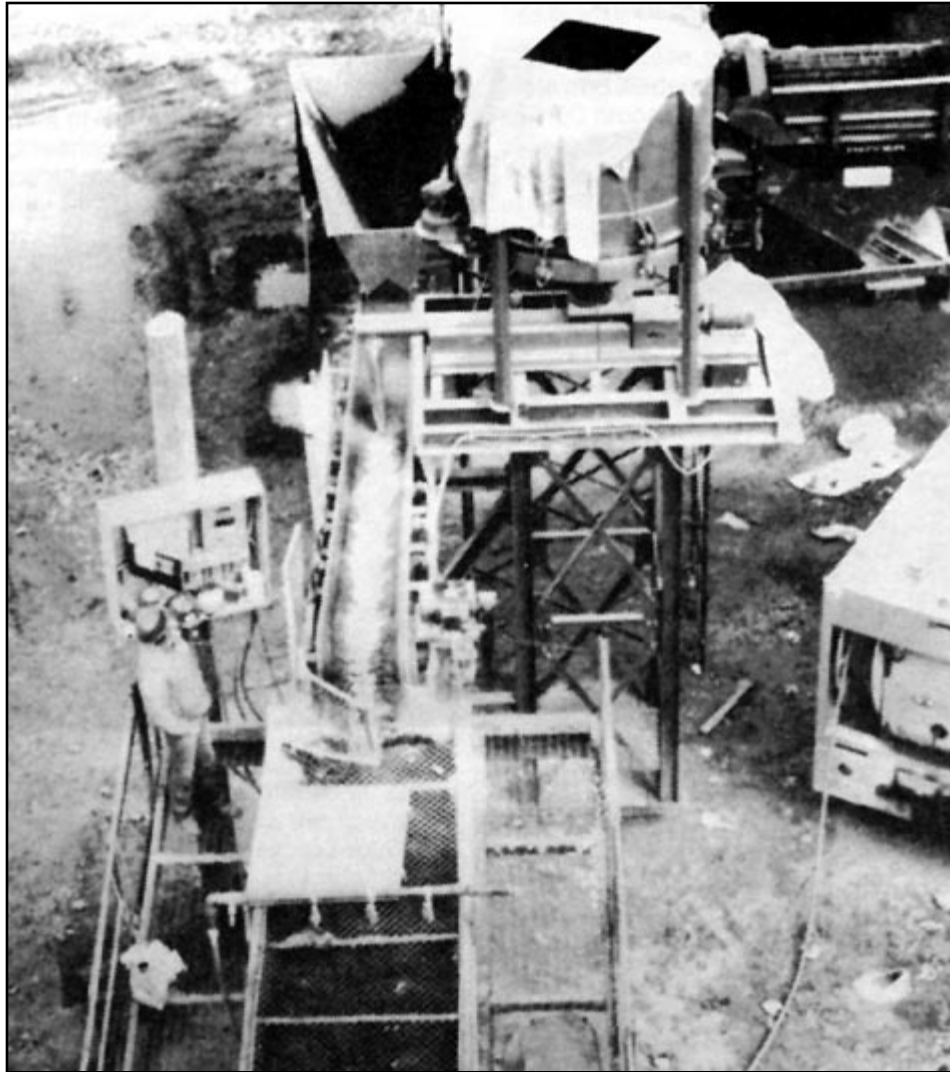

Photograph courtesy National Lime Association

avoided by the proper addition of stabilization/solidification agent or by timely transportation to the stabilized/solidified waste disposal area. Figure 7-4 shows the loading of lime stabilized/solidified sludge into an unlined dump truck.

7.1.7 Stabilized/Solidified Waste Replacement

Replacement of the stabilized/solidified waste depends upon its form. For waste stabilized/solidified in situ, replacement is of no consequence. Cement-like materials should immediately be placed in their disposal area because they set up and harden.

The placement of soil-like materials should be performed in accordance with procedures used in the

road-building industry, where the stabilized/ solidified waste is placed in lifts of 8 to 10 inches with earth-moving equipment such as graders or bulldozers. These procedures are described in detail in Section 7.2. Reportedly, the U.S. Army Corps of Engineers uses "roller-compacted concrete" in dam construction. This technique may also be applicable to hazardous waste stabilization/solidification.

After it is placed, the waste is compacted. Determination of the optimum moisture content of the material (see Subsection 4.1.3) is required to assure proper compaction. The optimum moisture content is that which gives the greatest density to a given material. Moisture must be added because too little moisture does not provide the lubrication required for the soil

Figure 7-4. Photograph of unlined dump truck being loaded with lime stabilized/solidified sludge.

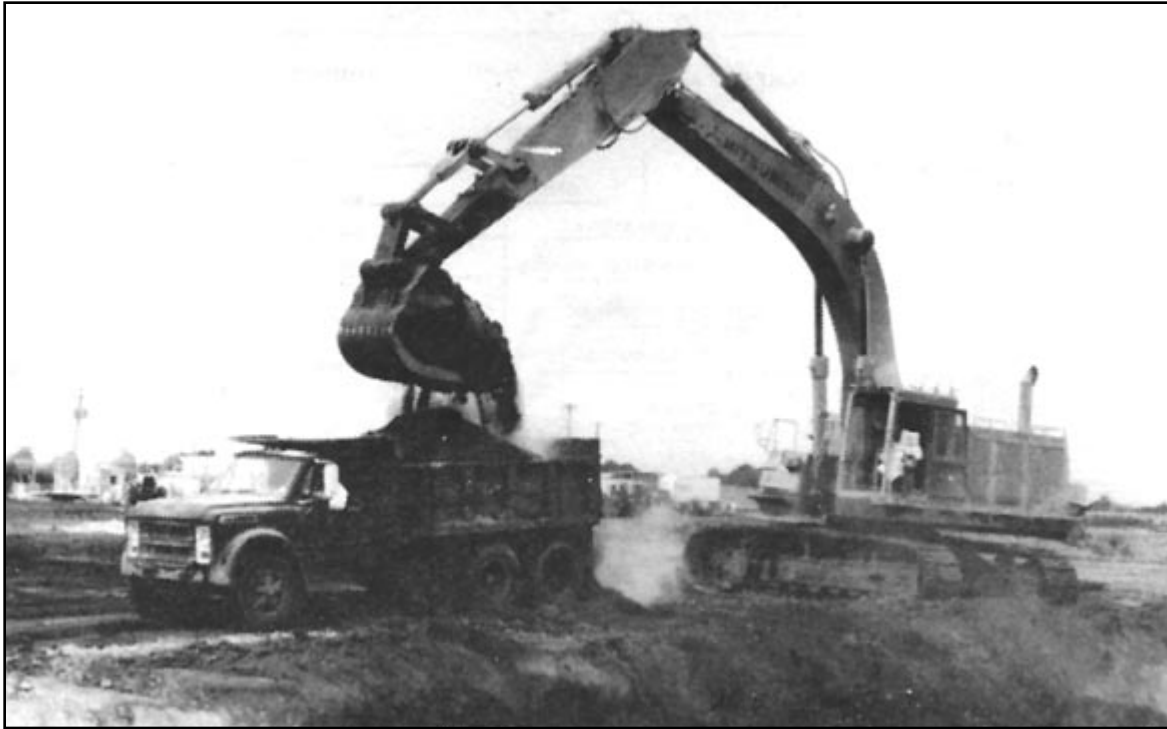

Photograph courtesy National Lime Association.

particles to slide past one another during compaction. On the other hand, too much moisture causes the material to approach the density of water, which is presumably lower than that of the waste. Thus, for soil-like, stabilized/solidified, hazardous waste, the amount of water in the waste must be controlled as it is compacted.

A second factor that affects the compaction of the waste is the particle size distribution of the material. Poorly graded wastes that are predominantly of one particle size do not compact well. Well-graded materials compact better because the void volume of the larger particles is occupied by smaller particles, which gives a better fit. This factor is usually one that cannot be controlled unless the particle size distribution of the stabilization/solidification agent can be regulated. Figure 7-5 shows the equipment that should be used for compaction of various-sized materials (Caterpillar 1987a). Use of this information requires the determination of particle size distribution of the stabilized/solidified material in the laboratory. This, plus an assessment of whether the material has the characteristics of clay, silt, or sand, enables one to make a proper choice of compacting equipment.

7.1.8 In Situ Processes

Waste stabilization/solidification can also take place at the site itself. These in situ processes, which have been in use since 1980, were described by Cullinane et al. (1986). One major application for them has been in old lagoons where waste has been present for decades. Not all are designed for lagoon work, however, and their specialized application can be both cost-effective and technically sound. In all of these processes, the entire range of functions described in Section 7.1 are combined into one operation.

7.1.8.1 In situ Mixing: Geo-Con System

The Geo-Con Company of Pittsburgh, Pennsylvania, has developed a system of stabilizing/solidifying waste materials in situ. This process has been used in EPA's Superfund Innovative Technology Evaluation (SITE) demonstration project in Hialeah, Florida. The equipment also has other geotechnical applications, such as the stabilization/solidification of dam foundations and in the construction of slurry walls.

The process is based on a combination of an auger and caisson, which operates in the waste. The stabilization/solidification agent is fed into the auger and

Figure 7-5. Chart used to select equipment for compaction of various-sized media.

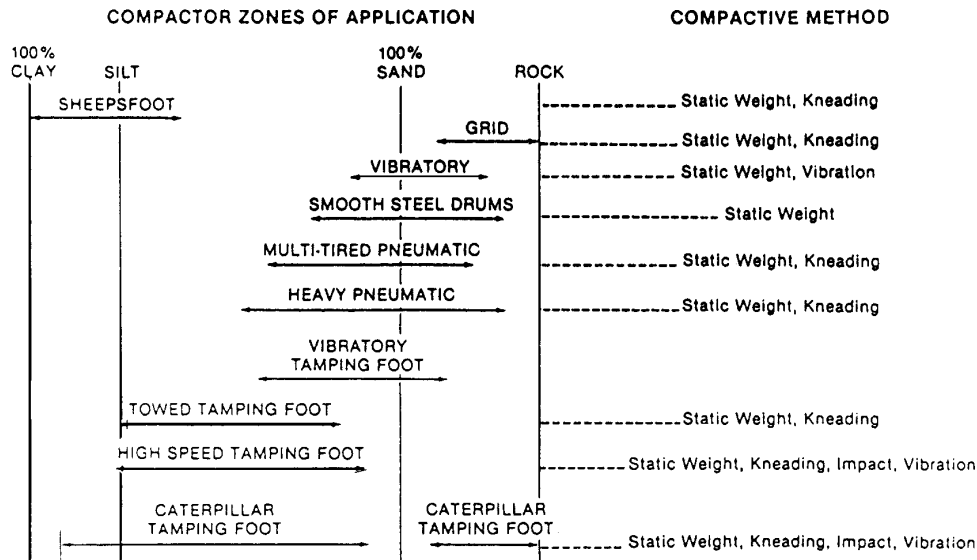

Source: Caterpillar, Inc. Caterpillar Performance Handbook, October 1987.

then into the waste through a hollow stem. Inside the caisson, the auger mixes the agent with the waste by a lifting and turning action. Geo-Con reports that it is possible to stabilize/solidify wastes to a depth of 100 feet. An important feature of the operation of this process is the overlapping bore patterns, which, if properly used, allow for complete coverage of the waste area.

The Geo-Con process is illustrated in Figure 7-6. The agent is fed from bulk storage tanks, usually in dry form. To date, Geo-Con has not specified the agents for use, but a variety of agents are available for this purpose. Prior to the mixing step, a liquid can be used to supply the water necessary for reaction between the stabilization/solidification agent and the waste and to improve mixing characteristics. A tracked backhoe can be used to carry the hydraulic drive that turns the auger. An exhaust fan draws air from the caisson through a dust collector and activated carbon for the removal of particulates and organics, respectively.

Typically, a week to 10 days is needed to mobilize this equipment. The process requires a crew of about eight people, and it is capable of processing 600 to 900 cubic yards of waste each day, depending on the

nature of the waste and the stabilization/solidification agent used.

The Geo-Con process has several advantages. First, the process is inherently less expensive than one that uses earth-moving equipment because the waste does not have to be excavated. Second, the water table does not have to be lowered. Third, fugitive emissions are controlled by the dust collector and the activated carbon tanks. Fourth, the quality control aspects of this process are good because the rate of addition of the stabilization/solidification agent can be regulated and the materials are well mixed. The one reported disadvantage of the process is its inability to penetrate masses containing boulders or other debris.

7.1.8.2 In Situ Mixing: ENRECO System

The ENRECO Company of Amarillo, Texas, uses an injection system for the stabilization/solidification of waste lagoons. The stabilization/solidification agent is fed to a lagoon through an injector on a backhoe. ENRECO manufactures its own equipment, and several variations of the basic design are available. Figure 7-7 is a photograph of ENRECO's equipment.

Figure 7-6. Crane-mounted mixing system advancing through unstabilized/unsolidified sludge layer.

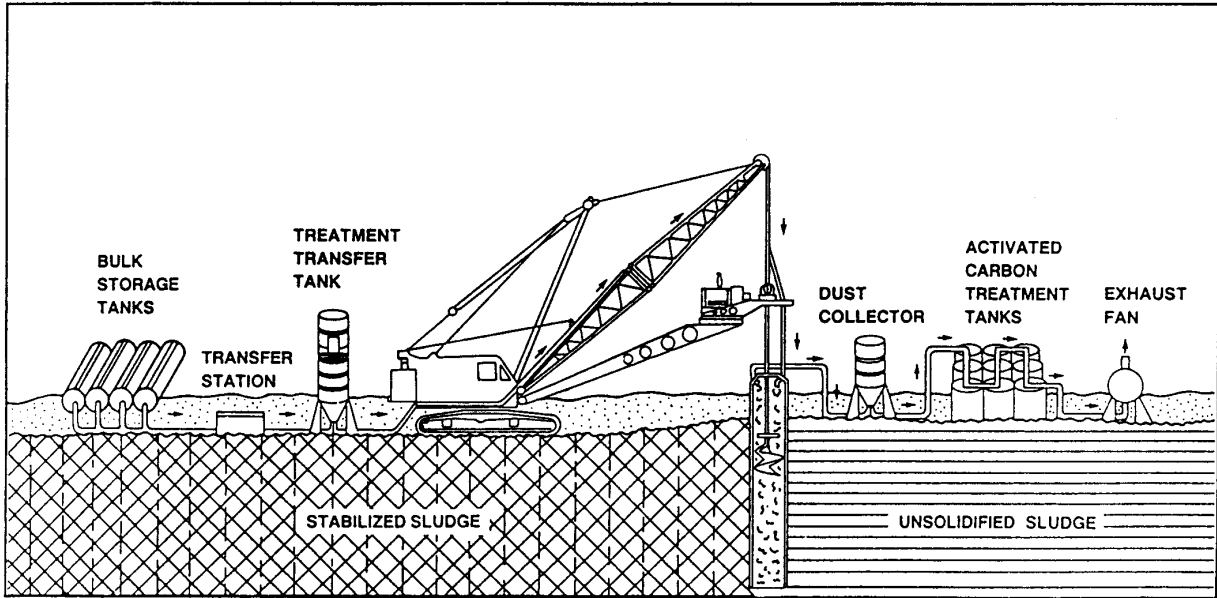

Source: Geo-Con Inc., Pittsburgh, PA.

Figure 7-7. Photograph of ENRECO backhoe equipped with stabilization/solidifying agent injector.



Photograph courtesy ENRECO Company.

The stabilizing/solidifying agent is delivered to the sites by truck, and it is often fed directly from a truck by a pneumatic system. Mixing is accomplished by the back and forth action of the injector and by the force of the pneumatic delivery.

The ENRECO system can stabilize/solidify to depths of 18 feet, although 10 feet is more common. Even greater depths have been reached by stabilizing/solidifying in 10-foot lifts, followed by removal. After the stabilization/solidification of a lift, the lagoons are solid enough to support the tracked backhoes that perform the removal. Typical processing rates are from 500 to 1500 cubic yards per day. A crew of three operators is required for each injection system. The stabilized/solidified material is usually left on site, but occasionally it is removed.

Typically, ENRECO uses cement, lime, or kiln dust as the reagent. These materials have been assembled from sources across the United States, so ENRECO is able to tailor the agent based on its source. Proprietary agents are also used, although infrequently. Volume is typically increased by 10 percent after stabilization/solidification. Reportedly, ENRECO has stabilized/solidified a variety of oil- and metal-bearing lagoons.

Quality control is maintained by sampling for unconfined compressive strength. A cone penetrometer or shear vane is used for the measurements. The EPA paint filter test is used to determine the presence of free liquids.

7.1.8.3 In Situ Mixing: Envirite System

Envirite of Plymouth Meeting, Pennsylvania, formerly American Resources Corporation, has 3 years' experience with in situ stabilization/solidification processing. Envirite uses two types of processing equipment, based on the depth of the waste. The first, called the HSS (High Solids Stabilization) System, consists of a rotary auger placed on the front end of a bulldozer. This system mixes the soil and stabilization/solidification agent in 8- to 10-inch lifts. The mixed waste is either compacted or transported elsewhere for disposal.

The second system, the PF-5 injector, is placed at the end of a tracked backhoe. This system can reach into a lagoon for remote access to the waste materials. The PF-5 unit uses five injection tubes, each with a separately controlled feed system, a dust control system, and a sludge/additive dispersion mixer. Impellers and augers at the outlet of the PF-5 have been designed to mix the waste and stabilization/solidification agent. The stabilization/solidification agent is blown into the PF-5, air-separated, transferred by screw conveyor, and mixed by the auger system. The PF-5 injector can stabilize/solidify material to a depth of approximately 10 feet; greater depths can be achieved with custom units.

Envirite uses cement, lime, or kiln-dust as a stabilization/solidification agent. These materials are custom-tested for each waste in Envirite's laboratory. Proprietary agents are not generally used by Envirite; however, the equipment is capable of accepting them. Equipment mobilization at a site requires several days. A crew of six is required to operate the equipment. Quality control is performed by sampling each 250 cubic yards of waste, which is measured for EP Toxicity (or TCLP) and unconfined compressive strength.

7.2 Stabilization/Solidification of Materials by Lime Stabilization Techniques

Lime stabilization is used to improve the characteristics of an area such as an airport runway or a highway roadbed (National Lime Association 1987; National Research Council 1987). Typically, lime and water are added to produce a material with increased strength and decreased plasticity index. Lime is generally added to clay materials, but other soils are also appropriate candidates. With respect to hazardous waste stabilization/solidification, the use of this technology is attractive for several reasons:

- 1) Lime is a base for many stabilization/solidification processes, either as a raw material itself or as a constituent of cement.
- 2) The equipment already exists for the process, and it can easily be adapted to hazardous waste use.
- 3) Much information has already been collected about the ancillary aspects of the process. For example, lime dusting and worker safety issues were addressed by the lime industry many years ago, and these issues can be easily implemented in the hazardous waste industry.

These stabilization/solidification techniques could be applied in several ways. First, and most closely related to the techniques of highway roadbed stabilization, would be the application of the stabilization/solidification agent to the uppermost layer of a soil, where it would be worked into the soil after being wetted. A second application of these techniques would be to place lifts of the waste and stabilization/solidification agent in a landfill. The stabilization/solidification agent would be reacted with the waste, possibly through the addition of water, and the mixture would be compacted so that additional lifts could be placed.

Another application of these techniques would be to use them with liquid or semiliquid wastes to which no water addition was required. Typical soil stabilization/solidification procedures include soil preparation, lime spreading, soil/lime mixing, compaction to the maximum practical density, and curing.

Soil preparation consists of those activities necessary to prepare the ground for acceptance of the lime stabilizer. Ground preparation would be required when a shallow layer of soil needed to be stabilized. In this instance, a grader-scarifier or disc harrow would be used for initial scarification. Soil pulverization also could be necessary. This is accomplished through the use of a disc harrow or rotary speed mixer.

Lime spreading requires the use of a variety of equipment. When shipment is by truck, self-unloading bulk tanker trucks are the most efficient for transporting and spreading the lime because no rehandling is involved. Unloading is effected pneumatically or by one or more integral screw conveyors. The spreading is accomplished with a mechanical spreader attached to the rear of the truck, or through metal downspouts or flexible rubber boots extending from each conveyor or airline.

Mixing is required to distribute the lime uniformly throughout the soil to the proper depth and width and to pulverize the soil to minus 2 inches. During this step, water may be added to raise the moisture content of the soil-lime mixture to the optimum. A rotary mixer is the best equipment for this purpose because of its uniform mixing, fine pulverization, and speed of operation. Blade mixing with a road grader is also satisfactory for some applications. Proper mixing is required for complete stabilization of all of the soil. The sharp contrast between the white lime and all

soils permits visual determination of the uniformity of the lime and soil mixture.

The lime-soil mixture should be compacted to at least 95 percent of the maximum density. Various rollers and layer thicknesses have been used for compaction in lime stabilization. The most common practice is to compact in one lift by use of a sheepsfoot roller (Figure 7-8), followed by a multiple-wheel pneumatic roller (generally a 10-ton roller). A flat-wheel roller is then used for finishing. Single-lift compaction can also be accomplished with vibrating impact rollers or heavy pneumatic rollers; light pneumatic or steel rollers would then be used for finishing. Compaction should take place as soon as possible after mixing, but a delay of several days is not detrimental. During compaction, light sprinkling may be required to keep the soil at its optimum moisture content.

After it has been compacted, the soil-lime mixture must cure. Temperature, moisture, and time are required for adequate curing. The temperature should be greater than 50°F, and the moisture should be close to optimum.

7.3 Site Conditions

Certain site-specific conditions can determine if a stabilization/solidification project is feasible. These include waste type, land use, safety, and geographic considerations.

Figure 7-8. Photograph of a sheepsfoot roller being used for compaction.



Photograph courtesy National Lime Association

7.3.1 Waste Type

The types of wastes most likely to be stabilized/solidified are liquids, sludges, and solids. Liquids and sludges are found primarily in lagoons. Solids also may be present in these lagoons, or they may occur as soils that have been contaminated by liquids.

Pretreatment of lagoon materials may be necessary for stabilization/solidification operations. Typical pretreatment operations include neutralization and water removal. Water removal may be a costly and extensive operation, especially if the waste is present beneath the local water table. In this case, dewatering may occur throughout the entire project. The water produced by dewatering must be treated. Several companies offer water treatment operations for remote site operation. These operations can remove solids, dissolved organics, and biological matter.

Access to lagoon materials can be difficult. The distance to the waste will determine whether a backhoe or a dragline is used for removal. For operations that provide for remote removal of the waste, whether the dikes will support the weight of the equipment must be considered. Proper width of the roads/dikes also must be ascertained. Some equipment (e.g., front-end loaders and bulldozers) may actually operate in a lagoon. The feasibility of operating this equipment in the waste must be considered. One consideration would be whether the waste can support the vehicle. If not, the use of wide tracks or low-pressure tires might make this operation feasible. Another consideration is the steepness of the dikes or walls surrounding a lagoon. At the one site, front-end loaders could not be used to carry waste over a dike and into dump trucks for this reason. Instead, an extra operation was necessary, which involved the use of backhoes to transfer the waste from the lagoon bottom to its side.

Soil treatment operations can disturb ongoing operations, and stabilization/solidification operations should be planned to keep this disturbance to a minimum. Dusting of the soil may be a problem, especially if the contaminant is present in high concentrations or if a large receptor population is nearby. Both dust suppression and the stabilization/solidification operation require water. Planners should determine if a source of water is present at the site if it is free of additional contaminants. If the soil contains concrete or large rocks, jackhammers will be needed for their removal. In addition, some soils at a site may not be appropriate candidates for stabilization/solidification even though they are contaminated. For example, an aquitard at the Frontier Hard Chrome Site was contaminated with hexavalent chromium (Dames & Moore 1987). Removal of this aquitard for stabilization/solidification could have inadvertently introduced contamination into the aquifer.

7.3.2 Land Use and Safety

Stabilization/solidification applications must include an appraisal of future site use. If the waste is very toxic, certain site uses (e.g., residential use) would be precluded after treatment. If the waste will not support structures, this option greatly limits the use of the site. One of the disadvantages of stabilization/solidification is that it increases the waste volume. A significant increase in an already large volume of waste could result in an unexpectedly large waste pile, in which case offsite disposal of a portion of the waste may be necessary.

Site operations require complete health and safety procedures for hazardous waste work. Workers in machinery may require supplied breathing air; others may require air-purifying respirators. Provision also must be made for adequate protective clothing (Level A, B, C, or D). Decontamination areas are essential for hazardous waste stabilization/solidification operations. The proximity of a site to nearby populations must be determined before the stabilization/solidification process is begun. Monitoring for dusts and organics may be necessary, and the presence of these materials in the atmosphere could prevent operations during unfavorable meteorological conditions.

7.3.3 Geography

This topic includes consideration of geology, surface waters, and meteorology. The principal geologic consideration is that relating to site aquifers. Waste that extends to aquifers may have to be dewatered as described earlier. Weather can have an effect on operations or the placement of the waste. For example, stabilization/solidification operations may not be feasible during freezing weather if the stabilized/solidified waste cannot cure. If the waste is subject to failure upon repeated freeze/thaw or wet/dry testing, an engineered solution can be required—i.e., simply placing the waste below the frost line. Finally, waste should never be placed in a floodplain.

7.3.4 General

Other considerations relate to the peculiarities of a site. For example, an area may be needed for stockpiling operations, and the absence of such an area could preclude stabilization/solidification as a remedial action. Power and utility sources for treatment operations are also important. If not available locally, electricity can be generated on site and water can be imported. Utilities can have an impact on field operations in another way as well; the presence of overhead power lines should be determined for safe operations at a site. Finally, any debris that is present in the waste may have to be removed. It is not unusual to encounter trees, large rocks, appliances, and other materials within a waste.

References

- American Nuclear Society (ANS). 1986. ANSI/ANS-16.1-1986 American National Standard Measurement of the Leachability of Solidified Low-Level Radioactive Wastes by a Short-Term Test Procedure. Prepared by the American Nuclear Society Standards Committee Working Group ANS-16.1. Published by the American Nuclear Society, La Grange Park, Illinois. Approved April 14, 1986, by the American National Standard Institute, Inc.
- Bishop, P. L. 1986. Prediction of Heavy Metal Leaching Rates From Stabilized/Solidified Hazardous Wastes. Toxic and Hazardous Wastes. In: Proceedings of the Eighteenth Mid-Atlantic Industrial Waste Conference, pp. 236-252.
- Bishop, P. L. 1988. Leaching of Inorganic Hazardous Constituents From Stabilized/Solidified Hazardous Wastes. Hazardous Waste & Hazardous Materials, 5(2):129-144.
- Bridle, T. R., et al. 1987. Evaluation of Heavy Metal Leachability From Solid Wastes. Water Science and Technology, Vol. 19, pp. 1029-1036.
- California Code, Title 22, Article 11. Criteria for Identification of Hazardous and Extremely Hazardous Wastes, pp. 1800.75-1800.82.
- Campbell, K., et al. 1987. Stabilization of Cadmium and Lead in Portland Cement Paste Using Synthetic Sea-water Leachant, Environmental Progress, 6(2).
- Carter, M. 1983. Geotechnical Engineering Handbook. Chapman and Hall, New York.
- Caterpillar, Inc. 1987a. Caterpillar Performance Handbook, Edition 18. Peoria, Illinois.
- Caterpillar, Inc. 1987b. Caterpillar Performance Handbook: Hydraulic Excavators. Peoria, Illinois.
- Cote, P. L., and T. W. Constable. 1982. Evaluation of Experimental Conditions in Batch Leaching Procedures. Resources and Conservation, Vol. 9, pp. 59-73.
- Cote, P., and D. P. Hamilton. 1984. Leachability Comparison of Four Hazardous Waste Solidification Processes. In: Proceedings of the 38th Industrial Waste Conference, May 1983, Purdue University, West Lafayette, IN.
- Cote, P. L., and T. R. Bridle. 1987a. Long-Term Leaching Scenarios for Cement-Based Waste Forms. Waste Management & Research, Vol. 5, pp. 55-66.
- Cote, P. L., T. W. Constable, and A. Moreira. 1987b. An Evaluation of Cement-Based Waste Forms Using the Results of Approximately Two Years of Dynamic Leaching. Nuclear and Chemical Waste Management, Vol. 7, pp. 129-139.
- Cullinane, M. J., Jr., L. W. Jones, and P. G. Malone. 1986. Handbook for Stabilization/Solidification of Hazardous Wastes. EPA/540/2-86/001. Hazardous Waste Engineering Research Laboratory, U.S. Environmental Protection Agency, Cincinnati, Ohio.
- Curry, M. 1986. Fixation/Solidification of Hazardous Waste at Chemical Waste Management's Vicery, Ohio, Facility. In: Proceedings of Hazardous Materials Control Research Institute Conference, December 1986. pp. 297-302.
- Dames & Moore. 1987. Feasibility Study of the Frontier Hard Chrome Site - Vancouver, Washington.
- Earth Technology Corp. 1988. Closure Plan and Post-Closure Care Plan for the Municipal and Industrial Disposal Co.
- The Earth Technology Corporation. 1988. Optimization of Soil Remediation Technologies Using Stabilization/Solidification.
- Environment Canada and Alberta Environmental Center. 1986. Test Methods for Solidified Waste Characterization.

- Federal Register, Vol. 51, No. 216, Friday, November 7, 1986, pp. 40643-40652.
- Fitzpatrick, V. F., C. L. Timmerman, and J. L. Buelt. 1987. In Situ Vitrification - An Innovative Thermal Treatment Technology. Paper presented at Groundwater Treatment Conference, New York, September 16-18, 1987.
- Gibbons, J. J., and R. Soundararajan. 1988. The Nature of Chemical Bonding Between Modified Clay Minerals and Organic Wastes Materials. *American Laboratory*, 20(2):38-46.
- Gilliam, T. M., L. R. Dole, and E. W. McDaniel. 1986. Waste Immobilization in Cement-Based Grouts. Hazardous and Industrial Solid Waste Testing and Disposal. Sixth Volume. ASTM STP 933, D. Lorenzen, R. A. Conway, L. P. Jackson, A. Hamza, C. L. Perket, and W. J. Lacy, eds. American Society for Testing and Materials. Philadelphia. pp. 295-307.
- Green, D. W., ed. 1984. "Processing Bulk Solids," in Perry's Chemical Engineers Handbook, 6th ed. McGraw-Hill, New York. pp. 21-3-10.
- JACA Corporation. 1985. Critical Characteristics and Properties of Hazardous Waste Solidification/Stabilization. Unpublished Report. Prepared for U.S. Environmental Protection Agency, Hazardous Waste Engineering Research Laboratory, Cincinnati, Ohio.
- Kolvites, B., and P. Bishop. 1987. Column Leach Testing of Phenol and Trichloroethylene Stabilized/Solidified with Portland Cement. University of New Hampshire, Department of Civil Engineering, Presented at the ASTM 4th International Hazardous Waste Symposium, Atlanta, Georgia. p. 27.
- Kyles, J. H., K. C. Malinowski, and T. F. Stanczyk. 1987. Solidification/ Stabilization of Hazardous Waste - A Comparison of Conventional and Novel Techniques, Toxic and Hazardous Wastes. In: Proceedings of the 19th Mid-Atlantic Industrial Waste Conference, June 21-23, 1987. Jeffrey C. Evans, ed. pp. 554-568.
- Lubowitz, H. R., and C. C. Wiles. 1979. Encapsulation Technique for Control of Hazardous Waste Disposal. In Toxic and Hazardous Waste Disposal, Vol. 1. R. B. Pojasek, ed. Ann Arbor Science, Ann Arbor, Michigan.
- Malone, P. G., L. W. Jones, and R. J. Larson. 1980. Guide to the Disposal of Chemically Stabilized and Solidified Waste. SW-872, Office of Water and Waste Management, U.S. Environmental Protection Agency, Washington, D.C.
- Martin, J. P., et al. 1987. Stabilization of Petroleum Refining Wastes for an On-Site Landfill. In: Proceedings Oak Ridge National Laboratory DOE Model Conference, October 1987.
- McGraw-Hill, Inc. 1988. Superfund Report, 11(4):15-16, February 17, 1988.
- Morgan, D., et al. 1984. Oil Sludge Solidification Using Cement Kiln Dust. *Journal of Environmental Engineering*, 110(5), October.
- Musser, D., ENRECO, and R. Smith, Raba-Kistner Consultants. 1984. Case Study: In Situ Solidification/Fixation of Oil Field Production Fluids - A Novel Technique. In: Proceedings of the 39th Industrial Waste Conference, Purdue University, West Lafayette, Indiana, May 1984.
- National Lime Association. 1987. Lime Stabilization Construction Manual. Bulletin 326. Arlington, VA.
- National Research Council. 1987. Lime Stabilization - Reactions, Properties, Design and Construction. Transportation Research Board, Washington, D.C.
- Newcomer, L. R., W. B. Blackburn, and T. A. Kimmell. 1986. Performance of the Toxicity Characteristic Leaching Procedure. December 1986.
- Rowe, G., and API Waste Treatment Task Force. 1987. Evaluation of Treatment Technologies for Listed Petroleum Refinery Wastes. Final Report, The American Petroleum Institute.
- R. S. Means Co., Inc. 1987 Means Heavy Construction Cost Data 1987. Kingston, Massachusetts.
- Shaw, M. D. 1987. Macroencapsulation: New Technology Provides Innovative Alternatives for Hazardous Materials Storage, Transportation, Treatment and Disposal. In: Proceedings of Hazardous Materials Control Research Institute Symposium. March 1987, Washington, D.C. pp. 96-100.

- Shively, W., et al. 1986. Leaching Tests of Heavy Metals Stabilized With Portland Cement. *Journal of Water Pollution Control Federation*, 58(3):234-241.
- Shively, W. E., and M. A. Crawford. Undated. EP Toxicity and TCLP Extractions of Industrial and Solidified Hazardous Waste.
- Skinner, J. H., and N. J. Bassin. 1988. The Environmental Protection Agency's Hazardous Waste Research and Development Program. *APCA J.*, 38(4):377-387, April 1988.
- Stegmann, J., P. L. Cote, and P. Hannak. 1988. Preliminary Results of an International Government/Industry Cooperative Study of Waste Stabilization/Solidification. In: *Hazardous Waste: Detection, Control, Treatment*. R. Abbou, ed. Elsevier Science Publishers B.V., Amsterdam, The Netherlands. pp. 1539-1548.
- Tittlebaum, M. E., et. al., 1985. "State of the Art on Stabilization of Hazardous Organic Liquid Wastes and Sludges." *CRC Critical Reviews in Environmental Control*, 15(2):191-193.
- Tittlebaum, M. E., et al. 1986. Procedures for Characterizing Effects of Organics on Solidification/Stabilization of Hazardous Wastes, Hazardous and Industrial Solid Waste Testing and Disposal: Sixth Volume. ASTM STP 933. D. Lorenzen, R. A. Conway, L. P. Jackson, A. Hamza, C. L. Perket, and W. J. Lacy, eds. American Society for Testing and Material, Philadelphia. pp. 308-318.
- Unger, S. L., et. al. Undated. Surface Encapsulation Process for Stabilizing Intractable Contaminants. Environmental Protection Polymers, Hawthorne, California.
- U.S. Army Corps of Engineers. 1980. Engineering and Design Laboratory Soil Testing. *Engineering Manual 1110-2-1906*. May 1970, updated 1980.
- U.S. Environmental Protection Agency. 1980. Hazardous Waste Management System: General Facility Standards. 45 FR 33066, May 19, 1980.
- U.S. Environmental Protection Agency. 1982. Interim Status Standards for Owners and Operators of Hazardous Waste Treatment, Storage, and Disposal Facilities. 47 FR 8307, February 25, 1982.
- U.S. Environmental Protection Agency. 1984. Case Studies - Remedial Response at Hazardous Waste Sites. EPA 540/2-84-002, February 1984. Trammel Crow Site and College Point Site.
- U.S. Environmental Protection Agency. 1985. National Oil and Hazardous Substances Pollution Contingency Plan. 50 FR 47950, November 20, 1985.
- U.S. Environmental Protection Agency. 1986a. Hazardous Waste Management System. 51 FR 46824, December 24, 1986.
- U.S. Environmental Protection Agency. 1986b. Test Methods for Evaluating Solid Waste, Method 9095, SW-846, Third Edition. November 1986.
- U.S. Environmental Protection Agency. 1986c. Prohibition on the Disposal of Bulk Liquid Hazardous Waste in Landfills - Statutory Interpretive Guidance. OSWER Policy Directive No. 9487.00-2A. EPA/530-SW-016, June 1986.
- U.S. Environmental Protection Agency. 1986d. Hazardous Waste Management System; Land Disposal Restrictions. 51 FR 40572, November 7, 1986.
- U.S. Environmental Protection Agency. 1986e. Handbook for Stabilization/ Solidification of Hazardous Waste. EPA/540/2-86/001.
- U.S. Environmental Protection Agency. 1986f. A Procedure for Estimating Monofilled Solid Waste Leachate Composition. Technical Resource Document SW-924, 2nd Edition. Hazardous Waste Engineering Research Laboratory, Office of Research and Development, Cincinnati, Ohio, and Office of Solid Waste and Emergency Response, Washington, D.C.
- U.S. Environmental Protection Agency. 1986g. SW-846 Test Methods for Evaluating Solid Waste, Vol. 1C: Laboratory Manual Physical/Chemical Methods, Third Edition. Office of Solid Waste and Emergency Response, Washington, D.C.
- U.S. Environmental Protection Agency. 1986h. Mobile Treatment Technologies for Superfund Wastes. Office of Solid Waste and Emergency Response. EPA 540/2-86/003, September 1986.

-
- U.S. Environmental Protection Agency. 1988a. Land Disposal Restriction for First Third Scheduled Wastes. 53 FR 11742, April 8, 1988.
- U.S. Environmental Protection Agency. 1988b. Land Disposal Restrictions for First Third Scheduled Wastes. 53 FR 31138, August 17, 1988.
- U.S. EPA. 1988c. Evaluation of Test Protocols for Stabilization/Solidification Technology Demonstrations. Revised Draft Report. U.S. Environmental Protection Agency, Office of Research and Development, Cincinnati, Ohio. Prepared by PRC Environmental Management, Inc. Contract No. 68-03-3484, April 25, 1988.
- U.S. Environmental Protection Agency. 1988d. Stabilization/Solidification Case Studies. Unpublished document.
- U.S. Environmental Protection Agency. 1989. Land Disposal Restrictions for Second Third Scheduled Wastes. Proposed Rules. 54 FR 1056, January 11, 1989.
- Van Keuren, E., et al. 1987. Pilot Field Study of Hydrocarbon Waste Stabilization, Toxic and Hazardous Wastes. In: Proceedings of the 19th Mid-Atlantic Industrial Waste Conference, June 21-23, 1987. Jeffrey C. Evans, ed. pp. 330-341.
- Vick, W., et al. 1987. Physical Stabilization Techniques for Mitigation of Environmental Pollution From Dioxin Contaminated Soils. Land Disposal, Remedial Action, Incineration and Treatment of Hazardous Waste. In: Proceedings of the 13th Annual Research Symposium, 1987. U.S. Environmental Protection Agency, Hazardous Waste Engineering Research Laboratory.
- Weitzman, L., L. E. Hamel, and E. Barth. 1988. Evaluation of Solidification/ Stabilization as a Best Demonstrated Available Technology. Paper presented at 14th Annual Hazardous Waste Engineering Laboratory Conference, Cincinnati, Ohio, May 1988.
- Wiles, C. 1987. A Review of Solidification/Stabilization Technology. Journal of Hazardous Materials, Vol. 14, 1987.
- Wiles, C. C. Undated. Treatment of Hazardous Waste in the United States With Solidification/ Stabilization. U.S. Environmental Protection Agency. Hazardous Waste Engineering Research Laboratory, Cincinnati, Ohio.
- 40 CFR 268.10 "First Third," Federal Register, August 17, 1988.
- Wiles, C., and H. Howard. Undated. USEPA Research in Solidification/Stabilization of Waste Material.