

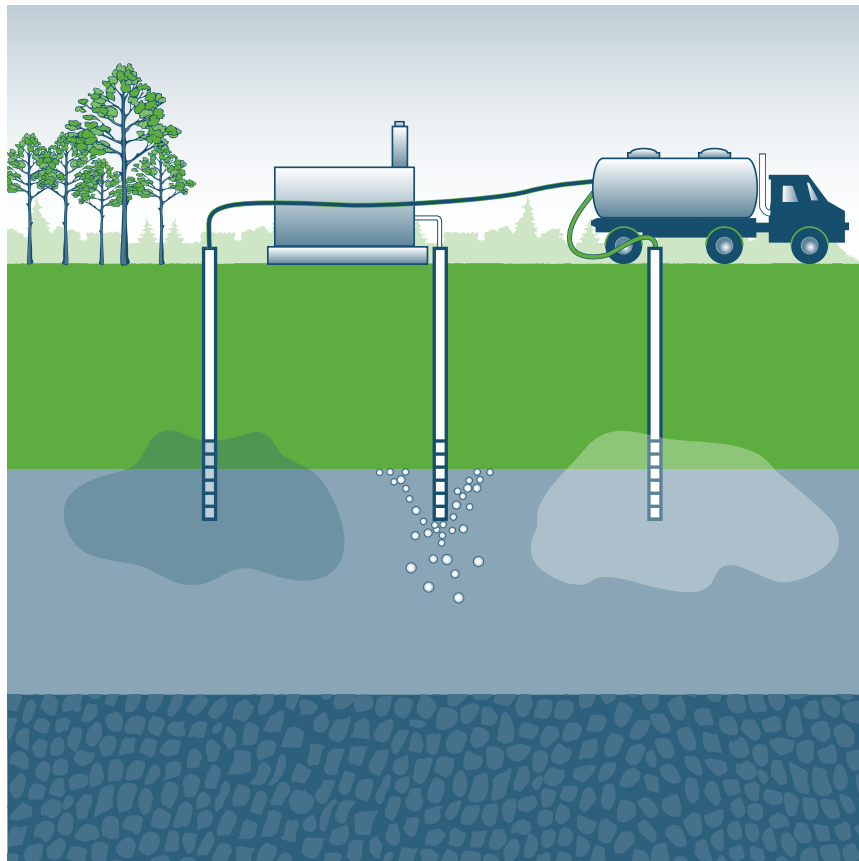

# Technical/Regulatory Guideline

## Technical and Regulatory Guidance for In Situ Chemical Oxidation of Contaminated Soil and Groundwater

*Second Edition*



January 2005

Prepared by  
The Interstate Technology & Regulatory Council  
In Situ Chemical Oxidation Team

## **ABOUT ITRC**

Established in 1995, the Interstate Technology & Regulatory Council (ITRC) is a state-led, national coalition of personnel from the environmental regulatory agencies of some 40 states and the District of Columbia; three federal agencies; tribes; and public and industry stakeholders. The organization is devoted to reducing barriers to, and speeding interstate deployment of, better, more cost-effective, innovative environmental techniques. ITRC operates as a committee of the Environmental Research Institute of the States (ERIS), a Section 501(c)(3) public charity that supports the Environmental Council of the States (ECOS) through its educational and research activities aimed at improving the environment in the United States and providing a forum for state environmental policy makers. More information about ITRC and its available products and services can be found on the Internet at [www.itrcweb.org](http://www.itrcweb.org).

## **DISCLAIMER**

This document is designed to help regulators and others develop a consistent approach to their evaluation, regulatory approval, and deployment of specific technologies at specific sites. Although the information in this document is believed to be reliable and accurate, this document and all material set forth herein are provided without warranties of any kind, either express or implied, including but not limited to warranties of the accuracy or completeness of information contained in the document. The technical implications of any information or guidance contained in this document may vary widely based on the specific facts involved and should not be used as a substitute for consultation with professional and competent advisors. Although this document attempts to address what the authors believe to be all relevant points, it is not intended to be an exhaustive treatise on the subject. Interested readers should do their own research, and a list of references may be provided as a starting point. This document does not necessarily address all applicable health and safety risks and precautions with respect to particular materials, conditions, or procedures in specific applications of any technology. Consequently, ITRC recommends also consulting applicable standards, laws, regulations, suppliers of materials, and material safety data sheets for information concerning safety and health risks and precautions and compliance with then-applicable laws and regulations. The use of this document and the materials set forth herein is at the user's own risk. ECOS, ERIS, and ITRC shall not be liable for any direct, indirect, incidental, special, consequential, or punitive damages arising out of the use of any information, apparatus, method, or process discussed in this document. This document may be revised or withdrawn at any time without prior notice.

ECOS, ERIS, and ITRC do not endorse the use of, nor do they attempt to determine the merits of, any specific technology or technology provider through publication of this guidance document or any other ITRC document. The type of work described in this document should be performed by trained professionals, and federal, state, and municipal laws should be consulted. ECOS, ERIS, and ITRC shall not be liable in the event of any conflict between this guidance document and such laws, regulations, and/or ordinances. Mention of trade names or commercial products does not constitute endorsement or recommendation of use by ECOS, ERIS, or ITRC.

**Technical and Regulatory Guidance for  
In Situ Chemical Oxidation of  
Contaminated Soil and Groundwater**

*Second Edition*

**January 2005**

**Prepared by  
The Interstate Technology & Regulatory Council  
In Situ Chemical Oxidation Team**

**Copyright 2005 Interstate Technology & Regulatory Council**

Permission is granted to refer to or quote from this publication with the customary acknowledgment of the source. The suggested citation for this document is as follows:

ITRC (Interstate Technology & Regulatory Council). 2005. *Technical and Regulatory Guidance for In Situ Chemical Oxidation of Contaminated Soil and Groundwater*, 2<sup>nd</sup> ed. ISCO-2. Washington, D.C.: Interstate Technology & Regulatory Council, In Situ Chemical Oxidation Team. Available on the Internet at <http://www.itrcweb.org>.

## ACKNOWLEDGMENTS

The members of the Interstate Technology & Regulatory Council (ITRC) In Situ Chemical Oxidation (ISCO) work team wish to acknowledge the individuals, organizations, and agencies that contributed to this technical and regulatory guidance document.

As part of the broader ITRC effort, the ISCO Team is funded primarily by the U.S. Department of Energy. The U.S. Department of Defense and the U.S. Environmental Protection Agency provide additional funding. ITRC operates as a committee of the Environmental Research Institute of the States, a Section 501(c)(3) public charity that supports the Environmental Council of the States through its educational and research activities aimed at improving the environment in the United States and providing a forum for state environmental policy makers.

The work team recognizes the efforts of the following state, federal, industry, academia, and consulting personnel who contributed to this document:

Anne W. Callison, Barbour Comm. Inc./Lowry AFB RAB  
Frank Camera, NJ DEP  
Doug Carvel, MECX, LLC  
Wilson Clayton, Ph.D., Aquifer Solutions, Inc.  
Eliot Cooper, Vironex  
Gary Cronk, Tait Environmental Management  
Diane Easley, EPA Region 7  
Eric Hood, Geosyntec Consultants  
Robert Kelley, Ph.D., Carus Chemical Company  
Jeff Lockwood, Florida DEP  
Leah MacKinnon, Geosyntec Consultants  
Michael C. Marley, XPert Design and Diagnostics, LLC (XDD)  
Scott Miller, Resource Control Corporation  
Nihar Mohanty, Massachusetts DEP  
Beth Moore, DOE EM-52  
Bill Mundy, Georgia Environmental Protection Division, Hazardous Waste Mgmt Branch  
Mary Jo Ondrechen, Northeastern University  
Ian T. Osgerby, Ph.D., USACE New England District  
Patrick Quinn, (Team Leader), Missouri DNR  
Paul Rodgers, Cedar Creek Engineering, Inc.  
Phil Block, Ph.D., FMC  
Marty Rowland, Rowland Management Group  
Frank Sessa, FMC  
Tom Stafford, Louisiana DEQ  
Jim Studer, InfraSUR, LLC  
Linda Warren, Carus Chemical Company  
Chuck Whisman, Groundwater & Environmental Services, Inc.  
Laura Yeh, Naval Facilities Engineering Service Center

Expert review of this document was conducted by participants of the Strategic Environmental Research and Development Program (SERDP) In Situ Chemical Oxidation research group. Review participants are listed below.

**SERDP In Situ Chemical Oxidation Technical Panel**

Bob Norris, Ph.D., retired consultant

Richard Brown, Ph.D., Environmental Resources Management

Mr. Mike Marley, Xpert Design and Diagnostics, LLC

Ian Osgerby, Ph.D., U.S. Army Corp of Engineers

**SERDP In Situ Chemical Oxidation Principal Investigators**

Michelle Crimi/Robert Siegrist, Colorado School of Mines

Richard Watts, Washington State University

Eric Hood, Geosyntec Consultants

Mark Zappi, Mississippi State University

## EXECUTIVE SUMMARY

The contamination of groundwater and subsurface soil in the United States is a widespread and challenging problem. There are estimated to be in excess of 200,000 sites requiring some form of remediation, and many of these sites potentially threaten groundwater resources. In areas where the groundwater resources are not considered at risk, there are frequently impediments to the reuse of “brownfield” sites. In addition, for many subsurface geological settings, conventional treatment methods, such as pump-and-treat technology, can be costly and inefficient. Emerging in situ groundwater and subsurface soil treatment technologies may provide effective, lower-cost alternatives, and it is important to fully understand all aspects of any new and innovative technology.

This guidance document was developed to outline the technical and regulatory requirements of in situ chemical oxidation (ISCO), a group of technologies involving various combinations of oxidants and delivery techniques. The primary oxidants addressed in this document are hydrogen peroxide, potassium and sodium permanganate, sodium persulfate, and ozone. The effectiveness of some of these oxidants can be enhanced through activation (Fenton’s reagent, activated persulfate) and used in conjunction with other oxidants (perozone). Additionally, this document is intended to expedite movement to a consensus on regulatory requirements through the Interstate Technology & Regulatory Council concurrence process. It should prove useful to regulators, stakeholders, consultants, and technology implementers.

The document is divided into sections consisting of technology overview and applicability, remedial investigations, safety concerns, regulatory concerns, injection design, monitoring, stakeholder concerns, and case studies. From a regulatory perspective, the most important sections of the document are identification of injection restrictions, implementation, and post-closure monitoring. Appendix D provides case studies of ISCO implementations, and the reference list includes documents with additional case study data.

Site characterization is a critical step in effectively applying any remedial technology. A complete understanding of the site geology, hydrogeology, and geochemistry, as well as the contaminant profile, is necessary for successful ISCO projects. To obtain a complete understanding of the site, it is important to develop a conceptual site model to integrate all data (contamination, potential sources, geology, major migration pathways, etc.) in three dimensions. Numerous hydrogeological and geochemical models are available to assist in site evaluations.

Regulatory issues associated with ISCO include the state or federal programs associated with underground injection control (UIC) and air quality. Permitting will typically not be an extensive process in ISCO deployment, as required permits may be limited to UIC concerns. Air quality concerns are limited to controlling fugitive vapors that may be produced. Monitoring requirements are discussed in Section 6 of this document.

Health and safety issues for ISCO include the following:

- Oxidants must be safely handled and stored.
- Permanganate and persulfate dust is hazardous.
- The presence of ozone increases the flammability of many materials.

- The generation of ozone can involve high-voltage-equipment concerns.
- There is a potential for uncontrolled exothermic reactions.
- There is a potential for preferential migration of oxidants and/or contaminants (liquid or vapor) through underground utilities.

As with all remediation technologies, it is important to address tribal and stakeholder concerns in detail. This process requires frank public discussion about the potential risks and benefits of the technology and about site-specific issues. This document provides detail on tribal and stakeholder concerns in Section 7.



## TABLE OF CONTENTS

ACKNOWLEDGMENTS .....	i
EXECUTIVE SUMMARY .....	iii
1. INTRODUCTION AND TECHNOLOGY OVERVIEW .....	1
1.1 Brief Descriptions of the Technologies .....	2
1.2 Appropriate and Applicable Uses of ISCO Technology .....	16
1.3 Integration of ISCO with Other Technologies.....	19
2. SITE CHARACTERIZATION AND CONCEPTUAL SITE MODEL .....	21
2.1 Specific Geologic and Chemical Data Needs .....	22
2.2 Screening Tools for Site Characterization.....	30
3. HEALTH AND SAFETY ISSUES.....	33
4. REGULATORY BARRIERS.....	35
4.1 Safe Drinking Water Act/Underground Injection Control .....	36
4.2 Resource Conservation and Recovery Act .....	36
4.3 Comprehensive Environmental Response, Compensation and Liability Act.....	36
4.4 Emergency Planning and Community Right-to-Know Act.....	39
4.5 Solutions to Regulatory Barriers .....	39
5. APPLICATION DESIGN.....	40
5.1 Laboratory Treatability Studies .....	40
5.2 Pilot-Scale Studies .....	41
5.3 Design of Oxidant Concentration and Volume .....	42
5.4 Design of Oxidant Delivery.....	46
6. MONITORING REQUIREMENTS.....	55
6.1 Process and Performance Monitoring.....	55
6.2 Post-Treatment and Closure Monitoring .....	60
7. TRIBAL AND STAKEHOLDER CONCERNS .....	60
8. CASE STUDIES.....	62
9. REFERENCES .....	64

## LIST OF TABLES

Table 1-1. Oxidant strengths .....	2
Table 1-2. Stoichiometric requirements for complete mineralization by permanganate .....	6
Table 1-3. Persulfate solubility .....	7
Table 1-4. Persulfate reactions as a function of pH .....	7
Table 1-5. General applicability of ISCO .....	17
Table 1-6. Oxidant effectiveness for contaminants of concern.....	17
Table 1-7. Considerations for in situ treatment with ISCO.....	18
Table 1-8. Summary of ISCO project implementation scenarios .....	19
Table 4-1. Regulatory permitting requirements for oxidant injection by state .....	37
Table 6-1. Injection well process parameters.....	59

Table 6-2.	Monitoring well process parameters.....	59
Table 8.1.	Case studies included in Appendix D.....	63

**LIST OF FIGURES**

Figure 1-1.	Factors influencing reactions.....	3
Figure 5-1.	Hydraulic radius of influence.....	43
Figure 5-2.	Permeability influences.....	49
Figure 5-3.	Bottom-up injections.....	49
Figure 5-4.	Batch versus recirculation.....	52
Figure 5-5.	Soil mixing.....	52

**APPENDICES**

Appendix A.	Acronyms
Appendix B.	Glossary
Appendix C.	Regulatory Examples
Appendix D.	Case Studies
Appendix E.	ITRC Contacts, Fact Sheet, and Product List

# TECHNICAL AND REGULATORY GUIDANCE FOR IN SITU CHEMICAL OXIDATION OF CONTAMINATED SOIL AND GROUNDWATER

## 1. INTRODUCTION AND TECHNOLOGY OVERVIEW

This document is the second edition of the Interstate Technology & Regulatory Council's (ITRC) *Technical and Regulatory Guidance for In Situ Chemical Oxidation of Contaminated Soil and Groundwater*. It provides a more comprehensive discussion on chemical oxidants than the first edition, along with a more detailed presentation of some of the key concepts of remedial design. The document is intended to serve as a technical and regulatory guide for stakeholders, regulators, and technology implementers involved in selecting and implementing in situ chemical oxidation (ISCO) as a remedial action. The four major oxidants used for soil and groundwater remediation—permanganate, persulfate, peroxide, and ozone—are discussed regarding the chemistry involved, the contaminants amenable to each oxidation process, and some of the problems encountered when using this remedial technology. Safety considerations for each oxidant are also reviewed, and case studies are included to illustrate how and when this technology has been applied.

The remediation of groundwater contamination using ISCO involves injecting oxidants and potentially coamendments directly into the source zone and downgradient plume. The oxidant chemicals react with the contaminants, producing innocuous substances such as carbon dioxide, water, and—in the case of chlorinated compounds—inorganic chloride. However, there may be many chemical reaction steps required to reach those end points, and some reaction intermediates, as in the case of polyaromatic hydrocarbons and organic pesticides, are not fully identified at this time. Fortunately, in most cases if an adequate oxidant dose is applied, the reactions proceed to completion, and the end products are reached quickly. Contaminants amenable to treatment by ISCO include the following:

- benzene, toluene, ethylbenzene, and xylenes (BTEX);
- methyl *tert*-butyl ether (MTBE);
- total petroleum hydrocarbons (TPH);
- chlorinated solvents (ethenes and ethanes);
- polyaromatic hydrocarbons (PAHs);
- polychlorinated biphenyls (PCBs);
- chlorinated benzenes (CBs);
- phenols;
- organic pesticides (insecticides and herbicides); and
- munitions constituents (RDX, TNT, HMX, etc.)

There are two main advantages of using ISCO over other conventional treatment technologies: large volumes of waste material are not usually generated, and treatment is commonly implemented over a much shorter time frame. Both of these advantages often result in savings on material, monitoring, and maintenance.

Like most technologies, ISCO has limitations that should be recognized. There are situations in which ISCO would be ineffective at degrading the contaminants present. It is also possible that due to the total volume of oxidant required, it would not be cost-effective to use ISCO for site remediation. Site-specific information—including the applicability of ISCO to the specific contaminants, the concentration range, and hydrogeologic conditions—must be gathered and reviewed when evaluating the appropriateness of using ISCO for a remediation strategy.

The information presented in this document is based on laboratory studies, pilot tests, and full-scale projects where ISCO has been used to remediate contaminated soil and groundwater. It points out important considerations to take into account during all remediation projects, including site characterization, remedial design, and the final remedy, as well as monitoring requirements.

### 1.1 Brief Descriptions of the Technologies

Chemical oxidation technology is based on the oxidative power of specific chemicals. Through the process of oxidation, groundwater contaminants are ultimately broken down into carbon dioxide and water. Some oxidants are stronger than others, and it is common to calculate a relative strength for all oxidants using chlorine as a reference. Table 1-1 lists the relative strengths of common oxidants.

**Table 1-1. Oxidant strengths**

<b>Chemical species</b>	<b>Standard oxidation potential (volts)</b>	<b>Relative strength (chlorine = 1)</b>
Hydroxyl radical ( $\text{OH}^{\bullet}$ )*	2.8	2.0
Sulfate radical ( $\text{SO}_4^{\bullet-}$ )	2.5	1.8
Ozone	2.1	1.5
Sodium persulfate	2.0	1.5
Hydrogen peroxide	1.8	1.3
Permanganate (Na/K)	1.7	1.2
Chlorine	1.4	1.0
Oxygen	1.2	0.9
Superoxide ion ( $\text{O}_2^{\bullet-}$ )*	-2.4	-1.8

\*These radicals can be formed when ozone and  $\text{H}_2\text{O}_2$  decompose.

Source: Siegrist et al. 2001

All the oxidants shown in Table 1-1 have enough oxidative power to remediate most organic contaminants. The standard potentials are a useful general reference of the strength of an oxidant, but these values do not indicate how they will perform under field conditions. Four major factors play a role in determining whether an oxidant will react with a certain contaminant in the field, three of which are illustrated in Figure 1-1. On a microscale, kinetics or reaction rates are perhaps the most important. In fact, reactions that would be considered thermodynamically favorable based on  $E_0$  values may be impractical under field conditions. The rates of oxidation reactions are dependent on many variables that must be considered simultaneously, including temperature, pH, concentration of the reactants, catalysts, reaction by-products, and system impurities (e.g., natural organic matter [NOM], oxidant scavengers, etc.).

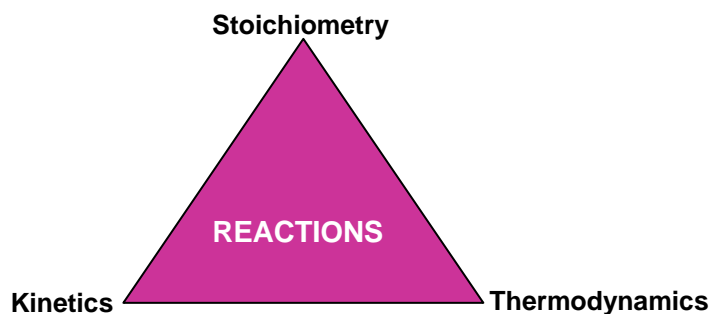

**Figure 1-1. Factors influencing reactions.**

oxidants are also consumed quickly in the subsurface, limiting the distance the oxidant can travel. Less reactive oxidants are more stable and can be transported greater distances in the subsurface. Therefore, the volume of aquifer to be treated is an important variable to consider when choosing an oxidant. The solubility of the oxidant in water, the usual injection fluid, is also important because it limits the mass of oxidant that can be injected per volume of injection fluid.

The fourth major factor involves the delivery of the oxidant. To effectively degrade contaminants, the oxidant must come into contact with the contaminant molecules. Ideally, the delivery technique would ensure that the oxidant is evenly dispersed throughout the area to be treated. Some of the more stable forms of contamination can be oxidized only with the stronger oxidants, but stronger

An important consideration for all ISCO designs, especially in source areas, is the amount of contaminated water displaced from the immediate vicinity. The volume that is injected into the saturated zone displaces same volume of groundwater with mixing occurring at the interfaces. In source areas where groundwater contamination is grossly elevated, this displacement should be minimized and controlled such that adequate contact with the oxidant is realized. The spatial distribution of both the contaminants and the injected oxidant is also greatly influenced by the commonly observed heterogeneous subsurface geology and the groundwater flow speed/direction.

This document attempts to describe the various oxidants from both theoretical and practical standpoints. Experience has shown that many variables are involved in using chemical oxidation to remediate contaminated soil and groundwater, some of which cannot be easily reproduced in the laboratory. For example, the well-mixed environment characteristic of laboratory tests is not typical of subsurface conditions in the field.

### 1.1.1 Permanganate

There are two common forms of permanganate—potassium permanganate ( $\text{KMnO}_4$ ) and sodium permanganate ( $\text{NaMnO}_4$ ). Both are available in a range of purities and have similar chemical reactivities.  $\text{KMnO}_4$  is a crystalline solid from which aqueous solutions of a desired concentration (up to 4%) can be prepared on site using ground- or tap water. Because it is a solid, transportation hazards are minimized.  $\text{NaMnO}_4$  is usually supplied as a concentrated liquid (40%) but is usually diluted on site and applied at lower concentrations. The potential for higher concentrations of sodium permanganate solutions gives more flexibility in the design of the injection volume and, because it is in liquid form, the dusting hazards associated with dry  $\text{KMnO}_4$  solids are eliminated. However,  $\text{NaMnO}_4$  has the additional hazard of being more highly reactive, with potential exothermic release if neutralized with concentrated reductants. Both forms of permanganate are strong oxidizing agents with a unique affinity for oxidizing organic compounds containing carbon-carbon double bonds, aldehyde groups, or hydroxyl groups. The stoichiometry and kinetics of permanganate oxidation at contaminated sites can be quite complex as there are numerous reactions

in which manganese can participate due to its multiple valence states and mineral forms. The primary redox reactions for permanganate are given in Equations 1–3. These half-cell reactions are useful for two purposes:

- to evaluate stoichiometric requirements of the oxidant for complete mineralization of contaminants via electron transfer balances and
- to determine potential environmentally significant reaction products.

For example, the half-cell reaction for permanganate under acidic conditions involves a five-electron transfer as shown in Equation 1, with  $\text{Mn}^{2+}$  produced. In the pH range of 3.5–12, the half-cell reaction involves a three-electron transfer as shown in Equation 2, with  $\text{MnO}_2$  (solid) as the primary reaction product. At high pH (>12), a single-electron transfer occurs as given in Equation 3, producing  $\text{MnO}_4^{2-}$ . In these three reactions, manganese is reduced from  $\text{Mn}^{+7}$  to either  $\text{Mn}^{+2}$  (Eq. 1),  $\text{Mn}^{+4}$  (Eq. 2), or  $\text{Mn}^{+6}$  (Eq. 3). Equation 2 represents the typical half-cell reaction under common environmental conditions and leads to the formation of a manganese dioxide solid.

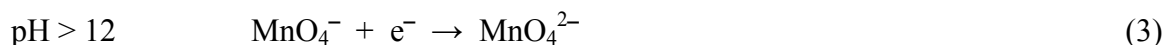
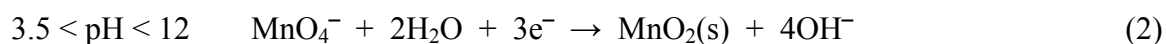
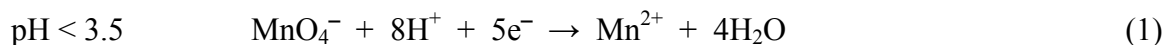

The  $\text{Mn}^{+2}$  cations formed under highly acidic pH conditions ( $\text{pH} < 3.5$ ) can be oxidized by excess (unreacted) permanganate ions and form a precipitate. However,  $\text{MnO}_2$  is also naturally reduced slowly to yield  $\text{Mn}^{+2}$ . These reactions are illustrated in Equations 4 and 5.

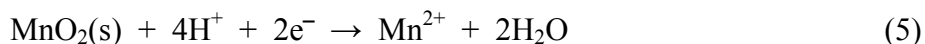

Equations 1 and 5 are significant from a regulatory perspective since highly acidic conditions may result in long-term elevated concentrations of  $\text{Mn}^{2+}$ . The initial subsurface pH, the mass of permanganate reacted, and the subsurface buffering capacity will influence the potential for this effect to occur.

Typical of all oxidants, permanganate can also react with water, but at very slow rates, resulting in nonproductive depletion of permanganate and further generation of  $\text{MnO}_2$  solids. When reduced species (contaminant or natural) are no longer available to react with permanganate, this slow decomposition process eventually results in depletion of excess permanganate that may remain in the subsurface after treatment. Permanganate decomposition reactions can also occur, but at appreciable rates only under extremely high pH. Permanganate is a stable oxidant and can persist in the subsurface for months. Thus, for ISCO projects with permanganate, the application rate and the total mass introduced must be balanced with the subsurface oxidizable material. For the degradation of chlorinated organic compounds, the oxidation involves direct electron transfer rather than free radical processes that characterize oxidation by persulfate, hydrogen peroxide, or ozone.

The stoichiometric reactions of  $\text{KMnO}_4$  with the various species of chlorinated ethenes are summarized below:

*Perchloroethene (PCE)*

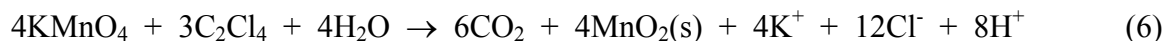

*Trichloroethene (TCE)*

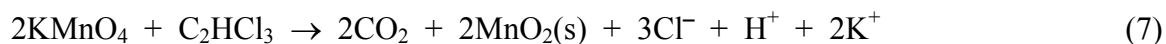

*Dichloroethene (DCE)*

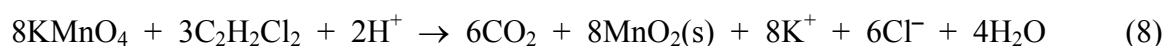

*Vinyl chloride (VC)*

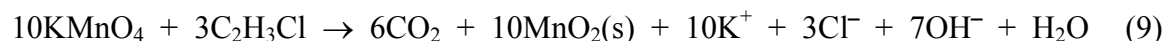

The rate of organic chemical degradation by permanganate in the absence of substantial NOM or other reductants depends on the concentration of both the contaminant and the permanganate and can be described by second-order kinetics. It is important to acknowledge that contaminant degradation rates are readily affected by the presence of competing species, such as naturally occurring organic matter or reduced mineral species. The rate of reaction is also temperature dependent. Reaction kinetics have been studied for common contaminants such as the chlorinated ethenes (e.g., Schnarr and Farquhar 1992; Gates, Siegrist, and Cline 1995; Yan and Schwartz 1996; Case 1997; Tratnyek et al. 1998; Huang et al. 1999; Siegrist et al. 1999; Struse 1999; Yan and Schwartz 1999; Urynowicz 2000). In general, chlorinated hydrocarbons with higher chlorine substitution consume less oxidant (per the stoichiometric requirement) and produce less  $\text{MnO}_2$  solids. Four moles  $\text{MnO}_4$  are needed to mineralize 3 moles of PCE producing 4 moles of  $\text{MnO}_2(\text{s})$  (Eq. 6), compared to 10 moles of  $\text{MnO}_4$  needed to mineralize 3 moles of vinyl chloride producing 10 moles of  $\text{MnO}_2(\text{s})$  (Eq. 9).

While offering certain advantages of stability and persistence, permanganate is not an effective oxidant for degradation of chlorinated alkanes such as 1,1,1-trichloroethane (1,1,1-TCA) (Gates, Siegrist, and Cline 1995; Tratnyek et al. 1998; Gates-Anderson, Siegrist, and Cline 2001). Saturated aliphatic compounds have no readily available electron pairs and are thus not easy to chemically oxidize. However, permanganate oxidation is highly effective on unsaturated compounds containing a carbon-carbon double bond because the oxidant can readily react with the more available electrons present. Unfortunately, electrons of the double bonds of aromatic compounds are more tightly shared and thus more stable than in aliphatic compounds. Permanganate is not effective at oxidizing most aromatic compounds. However, the available electron pairs constituting the double bond of both aromatics and aliphatics are more reactive when associated with substituted carbon atoms (i.e., chlorine present or an organic group such as  $\text{CH}_3$ ) due to the longer, less stable bond.

Permanganate has been used for chemical oxidation of phenolic compounds during wastewater treatment, but mineralization of phenol consumes a relatively large amount of permanganate (15.7 g of  $\text{KMnO}_4$  per gram of phenol). Polyaromatic hydrocarbons such as naphthalene, phenanthrene, and pyrene can also be oxidized by permanganate, and the cleavage of one of the aromatic rings usually occurs. However, since these compounds are frequently associated with fuel cleanup projects, much of the fuel-related contamination is not be oxidized, and thus permanganate is not the preferred oxidant. Like phenols, these compounds also exert a high demand for the oxidant. Limited studies with PCBs indicate that permanganate is not an effective oxidant for PCB degradation. However, permanganate oxidation of munition constituents (e.g., HMX, RDX, TNT, etc.) has been more successful (IT Corporation 2000). The viability of applying permanganate should be determined on a case-by-case basis and depends on the extent of contamination, the contaminant oxidant demand, the presence of competing naturally reduced materials, and treatment goals. Table 1-2 presents a comparison of the stoichiometric requirements for mineralization of several organic compounds with permanganate.

**Table 1-2. Stoichiometric requirements for complete mineralization by permanganate\***

Target compound	Compound molecular weight (g/mol)	Oxidant demand (g $\text{MnO}_4^-$ /g of target)	$\text{MnO}_2$ produced (g $\text{MnO}_2$ /g target)
Tetrachloroethene	165.6	0.96	0.70
Trichloroethene	131.2	1.81	1.32
Dichloroethene	96.8	3.28	2.39
Vinyl chloride	62.4	6.35	4.64
Phenol	94.1	11.8	8.62
Naphthalene	128.2	14.8	10.8
Phenanthrene	178.2	14.7	10.7
Pyrene	202.3	14.5	10.6

\*Molecular weight:  $\text{MnO}_4^-$  (118.9 g/mol),  $\text{KMnO}_4$  (158 g/mol),  $\text{NaMnO}_4$  (141.9 g/mol).

Oxidation of sorbed and nonaqueous-phase liquid chlorinated ethenes has been demonstrated with permanganate at various sites. These oxidation reactions occur in the dissolved aqueous phase after the contaminants desorb from the media and/or dissolve from the free phase.

Because permanganate, like all oxidants, is nonselective, it also oxidizes NOM present in the soil. Since organic contaminants sorb to NOM in the soil matrix, they can be released as the NOM is oxidized by the permanganate. After this initial contaminant release, the rate of continued desorption should be increased due to the shift in equilibrium partitioning that results as the aqueous-phase concentration of the target organic is depleted.

Poor performance of permanganate is often attributed to injection of an inadequate volume of oxidant to contact the entire target zone, poor uniformity of oxidant delivery caused by low-permeability zones and site heterogeneity, excessive oxidant consumption by natural subsurface materials, and/or the presence of large masses of dense, nonaqueous-phase liquid (DNAPL).



The following additional issues must be considered during the evaluation, design, and implementation of permanganate oxidation, regardless of the delivery system being employed:

- Permanganate is not effective at oxidizing benzene, chlorinated benzenes, MTBE, carbon tetrachloride, or chlorinated ethanes (1,1,1-TCA, etc.).
- As with all oxidants, the optimal oxidant loading, including both target and nontarget compounds, should be determined before injection.
- MnO<sub>2</sub> precipitates in the soil can reduce subsurface permeability.
- As with all oxidants, metals can be mobilized within the treatment zone due to a change in oxidation states and/or pH.
- There is a dust hazard to consider when handling potassium permanganate.
- Aggressive reactions are possible when concentrations of sodium permanganate greater than 10% are mixed with incompatible materials (reductant solutions, hydrogen peroxide, petroleum compounds, glycol, etc.).

### 1.1.2 Sodium Persulfate

Persulfate salts dissociate in water to persulfate anions (S<sub>2</sub>O<sub>8</sub><sup>2-</sup>) which, although strong oxidants, are kinetically slow in destroying many organic contaminants. Table 1-3 outlines the solubilities of three different commercially available persulfate salts. For ISCO applications, potassium persulfate has a low solubility, and the injection of ammonium persulfate may lead to the generation of ammonia, which is regulated in groundwater. Therefore, the most common salt used is sodium persulfate.

**Table 1-3. Persulfate solubility**

Salt	Solubility (at 25°C)
Ammonium persulfate	46%
Sodium persulfate	40%
Potassium persulfate	6%

The persulfate anion is a more powerful oxidant than hydrogen peroxide. Decomposition reactions vary with persulfate concentration, pH, and oxygen, and hydrogen peroxide or peroxydisulfate can be produced. Under dilute acid conditions, hydrolysis of the persulfate anion yields bisulfate anions and hydrogen peroxide. Table 1-4 illustrates how persulfate decomposition reactions vary with pH.

**Table 1-4. Persulfate reactions as a function of pH**

Solution pH	Reaction
Neutral	$S_2O_8^{2-} + 2H_2O \rightarrow 2HSO_4^- + \frac{1}{2}O_2$
Dilute acid (pH 3–7)	$S_2O_8^{2-} + 2H_2O + H^+ \rightarrow 2HSO_4^- + H_2O_2$ (Note the generation of peroxide)
Strong acid	$S_2O_8^{2-} + 2H_2O + H^+ \rightarrow HSO_4^- + HSO_5^-$
Alkaline (pH>13)	$S_2O_8^{2-} + OH^- \rightarrow HSO_4^- + SO_4^{2-} + \frac{1}{2}O_2$

The addition of heat or a ferrous salt (Iron II) dramatically increases the oxidative strength of persulfate. This increase is attributed to the production of sulfate free radicals (SO<sub>4</sub><sup>•-</sup>). Free radicals

are molecular fragments that have an unpaired electron, causing them to be highly reactive and short-lived. The sulfate free radical is a very potent oxidizing agent roughly equivalent to the hydroxyl radical generated using ozone or peroxide. Reactions involving radicals can be either chain-propagating or chain-terminating reactions. Chain-propagating reactions produce another radical, while chain-terminating reactions do not. Either type of reaction may or may not involve reactions with the target compounds (i.e., contamination present). Examples of free radical reactions involving persulfate are outlined below (Kislenko, Berlin, and Litovchenko 1995).

#### *Chain-Initiating Reactions*



#### *Chain-Propagating Reactions*

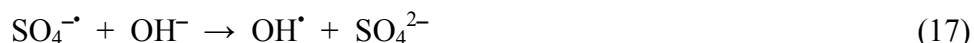
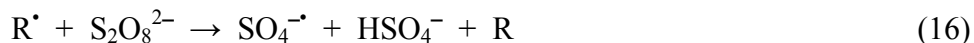

#### *Chain-Terminating Reactions*

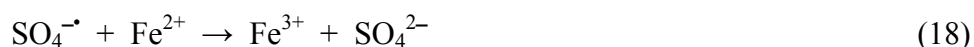

Application of heat will also generate these radicals via Equation 10. Iron is used in the above equations because it is commonly used to initiate the production of sulfate radicals ( $\text{SO}_4^{\bullet-}$ ). However, other metals, such as copper, silver, and manganese, can also initiate radical production although these are not common for environmental remediation applications. Note that iron is also involved in terminating reactions, so the ferrous ion concentration is important in controlling the propagating versus terminating reaction rates. Sulfate free radicals have a reported half-life of about 4 seconds under elevated temperature conditions ( $\approx 40^\circ\text{C}$ ) (Banerjee and Konar 1984). It may be expected that hydroxyl radicals have a somewhat shorter half-life because they are kinetically faster.

Ferrous ions require highly reducing conditions such as an acidic pH to remain in solution. It may be necessary to lower the pH as with peroxide systems to achieve this environment. Transport capabilities are important to all remedial technologies. For persulfate to be effective in field applications, the activator must be distributed and transported with the persulfate. One of the issues with Fe(II) salts is that they are oxidized to Fe(III). In a soil environment, where the soil has pH-buffering capacity, the Fe(III) that is formed precipitates out onto the soil. Thus, the effectiveness of the iron activation degrades with time and distance. Another approach involves the use of chelating agents, which aid in maintaining the ferrous iron solubility. Complexing the ferrous ions in solution, chelating is readily accomplished using carboxyl groups of inorganic acids (oxalic, citric). EDTA (ethylenediamine tetra-acetic acid, also NTA [nitrilotriacetic acid], STPP [sodium tripoly phosphate], HEDPA [hydroxide ethidene dual phosphoric acid]) is routinely used in modified Fenton's systems and may be applicable to persulfate systems (Liang et al. 2003a, b, and c).

Another approach to activate the sulfate radical is the use of elevated pH. In theory, a basic solution should increase the production of hydroxyl free radicals as they can be generated by the reaction of OH<sup>-</sup> and another radical. In research, lime has been added to generate an excess of hydroxyl ions, and then persulfate is thermally activated to form sulfate free radicals (from the heat of hydration of the lime) as an effective means of dechlorinating PCBs. Recent work has also demonstrated that persulfate under alkaline conditions in excess of a pH of 10.5 can decompose chlorinated ethanes, such as TCA and dichloroethane (DCA), and chlorinated methanes, such as carbon tetrachloride and chloroform. The stoichiometry of the direct sodium persulfate oxidation of TCE requires three moles of sodium persulfate per mole of TCE and is described as illustrated below:

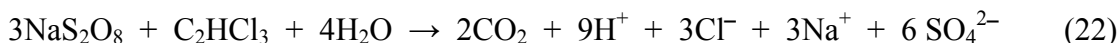

Sulfate free radical processes follow a much more complicated pathway and involve initiation, propagation, and termination steps as described in Equations 10–21. Not only is the sulfate radical (SO<sub>4</sub><sup>•-</sup>) formed, which is kinetically faster than persulfate anion, but hydroxyl radicals (OH<sup>•</sup>) and organic radicals may be formed. The formation of these multiple radicals provides a very effective tool in destroying recalcitrant compounds. Theoretically, if the chain-terminating processes are slow with respect to the chain-propagating paths, then relatively small amounts of sulfate radicals can generate significant contaminant decomposition, less than the stoichiometric quantities for the direct oxidation of Equation 22. As the persulfate anion is kinetically slow in oxidation, its interaction with NOM has been observed to be limited and much lower than that for peroxide or permanganate. Recent studies also have shown that the soil oxidant demand for sulfate radicals is much lower than that for permanganate and hydroxyl radicals. A confounding influence, however, is that chloride ions, as well as carbonate and bicarbonate ions, can act as radical scavengers for sulfate free radicals. If these scavengers are present at high concentrations, they can reduce oxidant effectiveness.

An interesting variant is currently being investigated in which an in situ thermal technology is being applied on sites where the contaminants are chlorinated ethanes, to be followed by a persulfate application, using the synergistic mechanism of thermal degradation of contaminants and thermal activation of persulfate to form sulfate free radicals. Thermal activation is very effective at initiating the production of sulfate radicals, and a heat-activated oxidative system also has the advantage that

many of the volatile organic compounds (VOCs) thermally degrade, thereby decreasing the amount of persulfate required and offsetting the cost of heating. Care must be taken to ensure that contaminants do not volatilize into the soil gas and migrate off site before destruction occurs.

Oxidation of VOCs in groundwater with persulfate also has the potential to lower the pH. In water, without soil present to buffer the pH, the pH generally drops to the range of 1.5–2.5, depending on the amount of persulfate used. This change in conditions could act to mobilize naturally occurring and/or anthropogenic metals present in the soil. In a soil environment, however, the pH drop may not be as severe as observed in water only because many soils have a pH-buffering capacity and can mitigate the formation of sulfuric acid. Theoretically, several concerns should be addressed when using persulfate to oxidize VOCs in soil and groundwater:

- Fe(II) does not appear to effectively activate persulfate with chlorinated ethanes (1,1,1-TCA, etc.) and methanes (chloroform, etc.). However, recent work with persulfate under alkaline conditions demonstrates effectiveness against these contaminants.
- The catalytic effect of the iron appears to decay with time and distance from injection. This decrease could be the result of either poor transport of the dissolved Fe(II) in a soil environment or the depletion of the iron as it activates the persulfate. Chelated iron effectively increases the iron solubility and longevity of Fe(II) in the groundwater.
- Low pH conditions may be generated by persulfate decomposition, which can cause dissolved metal concentrations to increase in the groundwater. Natural soil buffering capacity can help alleviate this phenomenon.
- Persulfate may degrade soft metals such as copper or brass. Materials of construction should be compatible with long-term persulfate exposure. Appropriate materials include stainless steel, high-density polyethylene, and polyvinyl chloride (PVC).
- As with all oxidants, the optimal oxidant loading, including both target and nontarget compounds, should be determined before injection.
- As with all oxidants, metals can be mobilized within the treatment zone due to a change in oxidation states and/or pH.

### 1.1.3 Peroxides/Fenton's Reagent

Like persulfate, hydrogen peroxide alone is an oxidant, but at low concentrations (<0.1%) it is not kinetically fast enough to degrade many hazardous organic contaminants before decomposition occurs. However, the addition of a ferrous salt iron(II) dramatically increases the oxidative strength of peroxide. This increase is attributed to the production of hydroxyl radicals (OH<sup>•</sup>). In addition, a chain reaction is initiated, causing the formation of new radicals. Because it was first discovered by H. J. H. Fenton, the reaction of iron catalyzed peroxide oxidation at pH 2.5–3.5 is called a “Fenton's reaction,” and the iron/peroxide mixture is known as “Fenton's reagent.” Fenton's reaction was initially developed at peroxide concentrations of about 300 ppm (0.03%), oxidizing the iron(II) (Fe<sup>2+</sup>) to insoluble iron(III)(Fe<sup>3+</sup>). If the pH is less than 5, the iron(III) is reconverted to iron(II), and the iron remains in solution to continue the initiation of hydroxyl radical production. The basic hydroxyl radical chain initiating Fenton's reaction is as follows:



A classical Fenton's system cannot be readily created in situ as it is generally too difficult to maintain a well-mixed, low-peroxide concentration in the subsurface. In practice, more concentrated solutions of hydrogen peroxide are injected, ranging 4%–20%, with iron in acid solution either coinjected (separate injection strings or nozzles) or injected separately, sequentially. In some cases iron may be present in the subsurface at sufficient concentrations that may eliminate the need for further iron augmentation. Any deviation from the traditional low-concentration hydrogen peroxide/iron mixture is known as a “modified Fenton's system.” This includes the use of high concentrations of H<sub>2</sub>O<sub>2</sub> or calcium peroxide (Ca<sub>2</sub>O<sub>2</sub>), with or without chelating agents. This type of system is significantly more complicated than traditional Fenton's. Hydroxyl radicals are very strong oxidizing agents. A chain-propagating sequence usually takes place, which can also generate superoxide ions (O<sub>2</sub><sup>•-</sup>), hydroperoxide ions (HO<sub>2</sub><sup>•</sup>), and organic radicals (R<sup>•</sup>). As with persulfate, reactions involving radicals are either chain-propagating or chain-terminating reactions. Equation 23 is an example of a chain-initiating reaction because the initial hydroxyl radicals are formed. Other examples of radical reactions involving hydrogen peroxide are outlined below.

#### *Chain-Propagating Reactions*

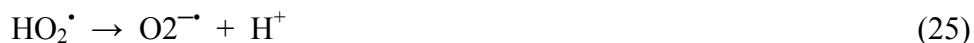

#### *Chain-Terminating Reactions*



When hydrogen peroxide is present in excess, many more radicals are produced when compared to Fenton's reaction. In addition to the reactions that occur between the oxidant and the organics present (Eqs. 26 and 27) as in Fenton's, radical-propagating reactions also occur involving the excess H<sub>2</sub>O<sub>2</sub> (Eqs. 24, 25, and 26). Therefore, there are more radicals available to react with the contamination. In almost all cases, the intermediates that are produced in these reactions are more biodegradable when compared to the parent compound. An important side reaction also occurs resulting in the formation of precipitates—it involves the reaction of two end products of this chain reaction, hydroxide ions and Fe(III):

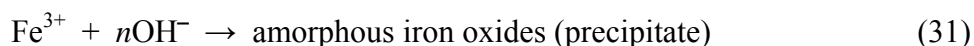

This side reaction consumes available iron and is favored by a basic pH. Therefore, it is necessary to either lower the pH or use chelating agents to maximize the available iron(II). The optimal pH is

acidic, ranging 3.5–5. Typical acids commonly used to alter the subsurface pH include HCl, H<sub>2</sub>SO<sub>4</sub>, and acetic acid. However, organic acids have a tendency to increase side reactions that are undesirable in high-organic soils. Another way to increase the iron solubility is to use a chelating agent. It should be noted that inorganic metal compounds present in the subsurface, manganese, for example, can cause terminating reactions to occur as well as provide the conditions (in principle) for a modified Fenton propagating sequence.

Certain physical properties are very important to successful applications using in situ oxidation with hydrogen peroxide. For example, peroxide's exothermic characteristic, when controlled, can be very beneficial to enhance the desorption and dissolution of sorbed and nonaqueous-phase liquid (NAPL) mass, making it available for effective treatment by oxidation or mass transfer systems. When not controlled, these same characteristics can cause migration of the contaminants. This exothermic but short-lived reaction can be extended when modified by the reduction in concentration of peroxide and rate of application or by the use of chemical additive stabilizers or inhibitors that delay the reaction rate of the peroxide.

As with other oxidation technologies, metal mobilization due to the lowering of pH appears to be generally short-lived. In most cases, the pH rapidly reverts to preinjection conditions because of the buffering capacity of the soil. However, under the right conditions, there is a potential for vigorous uncontrolled reactions in the subsurface with H<sub>2</sub>O<sub>2</sub>, resulting in the release of heat. The higher the concentration of H<sub>2</sub>O<sub>2</sub> injected, the more aggressive the reaction. It should be noted that volatile compounds may be released to the subsurface air by even moderate changes in temperature. Therefore, care must be taken in the design process to either minimize or utilize the heat generated from the H<sub>2</sub>O<sub>2</sub> reactions. The presence of hydroxyl radical scavengers must also be considered. Carbonate ions and metal compounds can react with radicals, thereby terminating the chain reaction. This phenomenon can increase the demand for oxidant and must be evaluated as part of the design. As a side benefit, aerobic biodegradation of contaminants can benefit from the presence of O<sub>2</sub> released during H<sub>2</sub>O<sub>2</sub> decomposition. There are several concerns should be addressed when using H<sub>2</sub>O<sub>2</sub> to oxidize VOCs in soil and groundwater.

- A low pH can cause dissolved metal concentrations to increase in the groundwater.
- Heat will be generated if strong solutions of peroxide (>10%) are used.
- There is potential gas generation/volatilization of contaminants.
- Carbonate ions exert a strong demand on hydroxyl radicals and acids (H<sup>+</sup> ions).
- As with all oxidants, the optimal oxidant loading, including both target and nontarget compounds, should be determined before injection.

#### 1.1.4 Ozone and Ozone with Hydrogen Peroxide

Ozonation is a very common municipal water treatment technology. However, over the past 20 years, more and more literature has been published that supports the concept of also using ozonation for treating complex organic pollutants. Ozone-based processes are unique to most other ISCO processes in that they involve application of a gas (ozone) posing very different design and operational issues than those faced with the application of the peroxide, persulfate, and permanganate liquid systems. There are two distinct forms of in situ ozone application: vadose zone injection of ozone gas and ozone sparging below the water table. More recently ozone has been

injected dissolved in water. Because of the differences in subsurface flow physics and chemical transport in these different applications, the operational and treatment considerations for these approaches are very different than that of the other oxidants. For ozone-based systems, ozonation (application of ozone alone) and peroxone (application of ozone and hydrogen peroxide) are most often considered. ISCO ozonation can also be applied using adjusted elevated pH conditions. This approach is a strategy for increasing hydroxyl radical production, which results in increased degradation rates of some pollutants (such as phenolics).

Ozone is one of the strongest oxidants available for ISCO. It is an allotrope of oxygen and is more soluble than oxygen in water. It is usually generated on site using ozone generators. Commercial generators using an air or oxygen stream usually generate ozone within the 2–10 wt% range. When ozone is introduced via the gas phase, the application rate is controlled by the phase equilibrium between gases and liquids. When typical ozonated feed gases are sparged into tanks containing clean water, the aqueous equilibrium ozone concentrations generally range 5–30 mg/L (Langlais, Reckhow, and Brink 1991). More recently, ozone has been injected in a dissolved phase as ozonated water or as an ozone/peroxide mixture, both of which have liquid distribution properties. This type of application is similar to that of the other oxidants.

Ozone oxidation chemical reactions may be divided into two categories: direct oxidation and indirect oxidation. Direct oxidation involves the oxidation of the targeted chemical by the parent oxidizer, ozone. Direct oxidation does not rely heavily on the hydroxyl radical ( $\text{OH}^\bullet$ ) for achieving targeted results. This process has found significant usage in water treatment. The second form of ozone oxidation reactions follows an indirect pathway and results in the production of the hydroxyl radical ( $\text{OH}^\bullet$ ) for contaminant oxidation. Hydroxyl radicals are nonselective oxidizers, which rapidly attack organic contaminants and break down their carbon-to-carbon bonds. Oxidation by hydroxyl radicals is a faster reaction than direct oxidation by the ozone itself. Oxidation products of most organic compounds are usually hydroxylated products, aldehydes, ketones, carboxylic acids, carbon dioxide, and water. For the direct oxidation pathway, typical modes of attack involve the insertion of the ozone molecule into unsaturated carbon-carbon bonds which results in the formation of an ozonide (Qui et al. 1999).

#### *Direct Ozone Reaction*

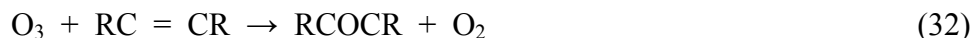

The second mode of organic oxidation is through the reaction with hydroxyl radicals, which are usually formed during ozonation due to the reaction with the hydroxide ion at neutral to basic pH ranges. Hydroxyl radicals can also be formed in the presence of ultraviolet light and by the reaction with certain cations. In addition to the production of these radicals, a chain reaction is also initiated causing the formation of new radicals.

#### *Chain-Initiating Reactions*



Within soil systems, the hydroxide ion and cationic-initiating steps are the most likely initiators. Promotion of hydroxyl radical formation may occur in the presence of key organic compounds such as alcohols, carboxylic acids, and humics (all fairly common constituents of most soil matrices). The hydroxyl radical chain-propagating and -terminating reactions are similar to those outlined for hydrogen peroxide and are summarized below.

*Chain-Propagating Reactions*

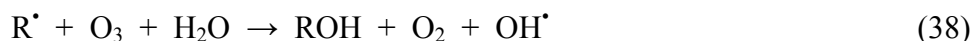

*Chain-Terminating Reactions*



The radical chain reaction can be terminated as outlined in the peroxide systems. In addition, radical scavengers are also common within soil matrices, including naturally occurring carbonates and oxidation products, mainly humic acids, and tertiary alcohols. These scavengers consume ozone and increase the ozone demand due to the nonselectivity of ozone and the hydroxyl free radical. However, only those reactions that result in pollutant removal are of value, while the others actually adversely affect remediation by increasing both cost and time requirements. In terms of ozonated ISCO processes, the key aquifer soil constituents of concern are high levels of bacteria biomass, total organic carbon, iron, manganese, hydrogen sulfide, and carbonates. The actual level of each that poses potential problems cannot be simply listed because of unique matrix effects that the combination of different matrix chemistries may impart. However, soils containing elevated levels of any one constituent listed above should offer some level of concern, and thus it is suggested, when there is doubt, some laboratory or pilot testing be initiated to ensure site compatibility (Dragun and Chiasson 1991). One particular scavenger that is not soil derived and yet can be very problematic is the overdosing of hydrogen peroxide (a common practice with Fenton's reagent applications), resulting in the scavenging reaction of the hydrogen peroxide with the generated hydroxyl radical.

Because many reactions are occurring at the same time, both  $\text{H}^+$  and  $\text{OH}^-$  are being generated, and the pH does not change appreciatively. Generally, the direct attack mechanism tends to lower the pH, while the radical pathway tends to increase it. ) The half-life of ozone in the presence of water is typically 30 minutes at standard temperatures and pressures, but it can be longer in subsurface environments because of natural deviation from standard temperatures and pressures. Since the mass



transfer of ozone to groundwater is limited, ozonation is typically sustained over a longer period of time than with other oxidants. To maximize mass transfer to groundwater, ozone is commonly delivered via sparge screens with very small orifices such that fine bubbles form. Also, ozone can potentially be dissolved into water and injected in dissolved form. The contaminants are treated in situ, converted to innocuous and/or naturally occurring compounds (e.g., H<sub>2</sub>O, CO<sub>2</sub>, O<sub>2</sub>, halide ions).

Because ozone is a gas, it can easily be used to remediate vadose zone contamination. As a side benefit, when it decomposes, ozone provides oxygen to the microbial community, which can aid in bioremediation. However, it can also be a sterilizing agent in high concentrations or long residence times, so ozone must be carefully controlled if bioremediation is to be encouraged. Groundwater with a high carbonate concentration can limit the effectiveness of this oxidant.

Several issues involved with the use of ozone to oxidize VOCs in groundwater:

- Longer injection times may be required than for other oxidants.
- There is potential gas generation/volatilization of contaminants.
- There is a potential for subsurface sterilization with longer injection times, but this effect is usually localized to within a few feet of the injection well and is a temporary phenomenon.
- Carbonate ions exert a demand on hydroxyl radicals.
- As with all oxidants, the optimal oxidant loading, including both target and nontarget compounds, should be determined before injection.
- As with all oxidants, metals can be mobilized within the treatment zone due to a change in oxidation states and/or pH.

Numerous successful applications of ozonation ISCO processes have been reported using ozone injection alone as well as ozone in combination with hydrogen peroxide (Nelson and Brown 1994; Amarante 2000; Nimmer, Wayner, and Morr 2000). Ozone–hydrogen peroxide reactions result in enhanced generation of hydroxyl radicals. This mechanism for the formation of hydroxyl radical during ozone–hydrogen peroxide treatment involves production of hydroxyl radicals by direct hydrogen peroxide and ozone reactions and through intermediate ozone and hydrogen peroxide reactions. The general reaction can be summarized as follows:



This mechanism for the formation of hydroxyl radicals during peroxone treatment is complex and involves the production of hydroxyl radicals by peroxide and ozone independently and with intermediate products (Langlais, Reckhow, and Brink 1991). Some of these reactions are outlined below:

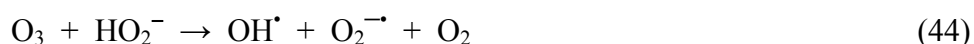



Many of the reactions that take place produce additional dissolved oxygen. For most ozone-injection systems that use an oxygen feed supply (as opposed to atmospheric air) to the ozone generator, a significant amount of oxygen can also be directly injected into groundwater (in some cases, ozone generators using an oxygen feed supply may be injecting approximately 90% oxygen and 10% ozone). Due to the significant amount of oxygen being injected into the subsurface and the oxygen-producing reactions, dissolved oxygen levels during ozone–hydrogen peroxide injection are typically very high and can help promote aerobic bioremediation downgradient of the injection points. Although microorganism populations can be limited in source areas, they can thrive downgradient where the oxidizing species are not present and water is saturated with oxygen.

Ozone–hydrogen peroxide injection has been used for many years to treat contaminants in water ex situ. Much research has been conducted during the past two to three years to implement effective in situ ozone–hydrogen peroxide injection (Wang et al. 2001, Fleming 2000, Tiang and Zappi 2003). It is important to understand the chemistry behind the ozone and hydrogen peroxide reactions to inject the appropriate volume of reactants. Ozone and hydrogen peroxide injection is considered to be one of the most aggressive forms of in situ chemical oxidation technologies due to the high yields of hydroxyl radicals obtainable (Hoigne and Bader 1983, Hong et al. 1996, Kuo and Chen 1996). In many cases ozone–hydrogen peroxide injection is much more aggressive for the removal of petroleum-based pollutants than ozonation and Fenton’s reagent used alone. In summary, when implementing ozone–hydrogen peroxide injection, there are more oxidizing species introduced into the subsurface reacting with many different contaminants and there can be significant downgradient dissolved oxygen bioremediation effects. Issues involved with the use of ozone–hydrogen peroxide to oxidize VOCs in groundwater are the same as those for the individual oxidants.

## 1.2 Appropriate and Applicable Uses of ISCO Technology

ISCO is potentially applicable over a range of contaminant concentrations from source area mass reduction to intercepting of plumes to remove mobile contaminants. Table 1-5 summarizes the general applicability of ISCO for treatment of organic contaminants at various concentration ranges, and describes alternative technologies that should also be considered in many cases.

Each oxidant has its own unique advantages and disadvantages. Contaminants of concern (COCs) commonly remediated through oxidation technologies include chlorinated solvents, PAHs, and petroleum products. This includes PCE and daughter products, the BTEX compounds, as well as naphthalenes. Stronger oxidants have been proven to be effective with chlorinated alkanes (chloroform, carbon tetrachloride, etc.). Table 1-6 contains more details on the suitability of oxidants for specific contaminants.

**Table 1-5. General applicability of ISCO**

Organic contaminant concentration range	ISCO applicable?	Considerations
Mobile NAPL*	Possible, but challenging	High oxidant dose
Residual NAPL*	Yes, but challenging	High oxidant dose
High groundwater concentrations*	Yes, a good fit	Standard
Low groundwater concentrations*	Yes, but may not be cost-effective	Cost driven by matrix oxidant demand and size of plume

\* Mobile NAPL—Continuous NAPL pools.  
Residual NAPL—Discontinuous NAPL globules.  
High groundwater concentrations—>10 mg/L.  
Low groundwater concentrations—<1 mg/L.

**Table 1-6. Oxidant effectiveness for contaminants of concern**

Oxidant	Amenable COCs	Reluctant COCs	Recalcitrant COCs
H <sub>2</sub> O <sub>2</sub> /Fe	TCA, PCE, TCE, DCE, VC, BTEX, CB, phenols, 1,4-dioxane, MTBE, <i>tert</i> -butyl alcohol (TBA), high explosives	DCA, CH <sub>2</sub> Cl <sub>2</sub> , PAHs, carbon tetrachloride, PCBs	CHCl <sub>3</sub> , pesticides
Ozone	PCE, TCE, DCE, VC, BTEX, CB, phenols, MTBE, TBA, high explosives	DCA, CH <sub>2</sub> Cl <sub>2</sub> , PAHs	TCA, carbon tetrachloride, CHCl <sub>3</sub> , PCBs, pesticides
Ozone/H <sub>2</sub> O <sub>2</sub>	TCA, PCE, TCE, DCE, VC, BTEX, CB, phenols, 1,4-dioxane, MTBE, TBA, high explosives	DCA, CH <sub>2</sub> Cl <sub>2</sub> , PAHs, carbon tetrachloride, PCBs	CHCl <sub>3</sub> , pesticides
Permanganate (K/Na)	PCE, TCE, DCE, VC, BTEX, PAHs, phenols, high explosives	Benzene, pesticides	TCA, carbon tetrachloride, CHCl <sub>3</sub> , PCBs
Activated Persulfate	PCE, TCE, DCE, VC, BTEX, CB, phenols, 1,4-dioxane, MTBE, TBA	PAHs, explosives, pesticides	PCBs

The two most critical success factors in all ISCO projects are the effective distribution of the reagents in the treatment zone and the reactivity of a particular oxidant with the contamination present. This combination requires careful site characterization, screening, and feasibility testing. Failure to account for subsurface heterogeneities or preferential flow paths can cause an uneven distribution of the oxidant, resulting in pockets of untreated contaminants. The applied reagents also consume natural organic matter in the soil, some of which has sorbed contamination. As the natural organic matter is consumed, the sorbed contamination will be released. Therefore, when applying liquid oxidants in the both the saturated and vadose zone, there is a potential to release contamination to the groundwater. This phenomenon is highly dependent on the transport properties of the soil. The more permeable the soil, the greater chance for release to groundwater because the oxidant has less time for reacting with the contaminants. Desorption of contamination can be

considered a benefit for remediation purposes because reactions typically occur in the aqueous phase and more contamination is available for reaction. The remedial design must account for both the sorbed and dissolved-phase contamination for effective site cleanup.

Important advantages of ISCO include its relatively low cost and the speed of reaction. However, because of the reactivity of the oxidants, there is potential to cause a significant change in both the concentration and distribution of contamination, potentially resulting in large changes in a site's established equilibrium of contaminants between the vapor, liquid, and sorbed phases. Therefore, experts should be consulted when designing all remediation projects. Table 1-7 identifies some considerations for in situ chemical oxidation treatment. Site-specific information is always needed for effective field application.

**Table 1–7. Considerations for in situ treatment with ISCO**

	<b>Peroxide</b>	<b>Ozone</b>	<b>Permanganate</b>	<b>Persulfate</b>
Vadose zone treatment	Successful	Successful	Successful	Successful
Potential detrimental effects	Gas evolution, heat generation, by-products, resolubilization of metals	Gas evolution, by-products, resolubilization of metals	By-products, resolubilization of metals	By-products, resolubilization of metals
PH/alkalinity	Effective over a wide pH range, but carbonate alkalinity must be taken into consideration	Effective over a wide pH range, but carbonate alkalinity must be taken into consideration	Effective over a wide range	Effective over a wide pH range, but carbonate alkalinity must be taken into consideration
Persistence	Easily degraded in contact with soil/groundwater unless inhibitors are used	Easily degraded in contact with soil/groundwater	The oxidant is very stable	The oxidant is very stable
Oxidant demand	Soil oxidant demand varies with soil type; contaminant oxidant demand is based on total mass and mass distribution (sorbed, dissolved and free phase)			
Soil permeability and heterogeneity	Low-permeable soils and subsurface heterogeneity offer a challenge for the distribution of injected or extracted fluids			

For chlorinated hydrocarbon remediation via chemical oxidation methods, the risk of a fire is reduced since those compounds are less flammable than BTEX. However, caution should be exercised to prevent the release or migration of quantities and concentrations of chlorinated vapors that may be harmful from a toxicological or environmental standpoint. Design and implementation considerations related to success include the following:

- Venting or negative pressure systems may be appropriate for some sites with ozone or Fenton's reagent to accommodate off-gasses and relieve pressure and buildup of organics. This

consideration is especially important if the ground surface is paved. Some state regulatory agencies may require negative pressure systems when using certain ISCO technologies.

- Utility surveys should be conducted to account for the effect of underground piping, utilities, or trenches on preferential pathways and/or pockets for organic decomposition, explosive liquids and vapors, and oxygen.

### 1.3 Integration of ISCO with Other Technologies

Historically, ISCO has been viewed as a stand-alone treatment technology for achieving cleanup objectives at many sites where the time factor and the nature of contamination require a more aggressive, rapid approach. This view, however, is being revisited as ISCO technologies prove useful as integral parts of sequential or more complex remedial approaches. This trend is being driven by a variety of site-specific concerns involving one or more of the following:

- complex mixtures of contaminants and/or intermingled plumes;
- the presence of NAPL;
- geologic, hydrogeologic, and geochemical limitations; and
- facility constraints such as ease of access and wellhead protection concerns.

ISCO is becoming a vital component of many site closure strategies whereby it is used to rapidly reduce high concentrations in soil and groundwater or to destroy mass present as NAPL. This approach enables other longer term and generally less expensive technologies to treat zones of lower concentration. In addition, under some circumstances, ISCO has been found to enhance mass transfer from soil to groundwater by breaking down NOM (and sorption sites) or increasing temperature, which can result in a more complete remediation of a site because both soil sources and groundwater contamination are removed or destroyed. The major improvements in the overall effectiveness of remedial designs when integrating ISCO involve supplementing traditional mass transfer (pump and treat, air sparging/soil vapor extraction [SVE], dual-phase extraction) and/or monitored natural attenuation (MNA) technology applications.

Current/emerging industry practice related to application of ISCO to specific soil/groundwater plumes includes the use of multiple ISCO technologies in concurrent or sequential fashion, using ISCO with other technologies, and enhancing ISCO with other technologies such as radio-frequency heating or surfactants. Table 1-8 provides general examples of how ISCO has been applied on projects across the United States.

**Table 1-8. Summary of ISCO project implementation scenarios**

<b>Initial technology</b>	<b>Following/concurrent technology</b>
Pump and treat	All oxidants
Air sparging/SVE	All oxidants
Resistive heating	All oxidants
Surfactants*	All oxidants
Persulfate or peroxide	Permanganate
All oxidants	Enhanced bioremediation

\*When considering the application of a peroxide based-treatment after the use of a surfactant flush, a treatability evaluation should be performed to ensure that the

surfactant is not polymerized by the peroxide. This polymerization could result in the severe reduction of permeability in the formation during the application if significant volumes of surfactant remain in the formation after their use.

### 1.3.1 ISCO Integration with Traditional Mass-Transfer Strategies

Traditional mass-transfer technologies are limited in their effectiveness because they must rely on the natural slow and inefficient desorption of the contaminants of concern from the soil. Desorption rates are related to the temperature and geochemical conditions of the site and the contaminant soil partitioning coefficient ( $K_{oc}$ ). In most cohesive or high organic content soils, the majority ( $\geq 80\%$ ) of the contaminant mass can be sorbed or present as NAPL. These systems have a tendency to rapidly reach an asymptotic slow recovery rate throughout mass-transfer remediation techniques. It is fairly easy to clean up soil gas and groundwater to acceptable levels without affecting the sorbed contamination. This situation increases the potential for contaminant rebound as the sorbed phase contamination equilibrates with the clean soil gas and groundwater. However, chemical oxidation technologies have the ability to release the sorbed contaminants by oxidizing the organic matter onto which the contaminant is sorbed and changing the chemical equilibrium between the sorbed mass and the groundwater, greatly increasing the effectiveness of traditional mass transfer technologies.

### 1.3.2 ISCO Integration with Biological Treatment Strategies

It has been demonstrated at many sites with varying lithologies and with a wide range of contaminants in both oxidizing and reducing environments that ISCO can enhance biological activity. Contaminant degradation is twofold: reduction of toxic source area contamination and the addition of chemicals beneficial to biological degradation of most organic contaminants (e.g.,  $O_2$  for aerobic microbes). It is extremely difficult for ISCO technologies to render a site biologically inactive, even those involving reductive dechlorinating (anaerobic) bacteria. Ozone, the only known oxidant with this potential, requires very high concentrations and long injection time frames to achieve complete biological inactivation. Even if this state occurs, it is only temporary and localized near injection points. Natural soil and groundwater systems are not closed systems, so bacteria repopulate areas where they have been depleted. Studies involving both chlorinated and nonchlorinated organic contaminants have shown that, in most treatment areas where ISCO is used, microorganisms are initially dormant before remediation due to the toxic concentrations within the source area. When these concentrations are reduced to less toxic levels, the environment becomes more acceptable for bacterial growth. Bacteria typically become quite viable if other, sufficient environmental conditions permit. Post-treatment populations have been demonstrated to grow rapidly within short periods after even the most aggressive treatments.

Aerobic biological enhancement occurs because the contaminant source and dissolved plume are reduced to less toxic concentrations and the dissolved oxygen content of the groundwater is increased, creating a subsurface environment for aerobic bacteria to flourish. Where chlorinated organics are being treated, some of the intermediate products of the degradation (e.g., cis-1,2-DCE) can be used by the indigenous aerobic bacteria as a food source. However, reducing environments are usually rapidly restored as the oxidant is consumed by the aerobic bacteria, NOM, and the contaminant targeted for oxidation.

Anaerobic biological enhancement in an in situ chemical oxidation post-treatment environment has been demonstrated (Rowland et al 2001, EPA 2004). Other investigators (Dennis, Hood, and Major 2004) have commented on the effects of permanganate on anaerobes. The enhancement mechanisms involved appear to include (a) the reduction of the contaminant source as free phase or DNAPL and as dissolved phase; (b) the increased availability of NOM substrate (through partial oxidation of NOM) for anaerobes; and (c) pH buffering. Reducing environments (and the viability of anaerobic contaminant-degrading microorganisms) are usually rapidly restored as the oxidant is consumed by NOM or the contaminant targeted for oxidation.

### 1.3.3 Enhancing ISCO with Innovative Approaches

ISCO's effectiveness is often hampered by site conditions such as low permeability and contaminated soils that are not fully saturated with water. The following processes should be considered to optimize the effectiveness of ISCO:

- ISCO is an aqueous-phase technology, so except for ozone, the oxidant must be applied to a saturated or near-saturated soil matrix.
- The oxidant must be evenly dispersed throughout the contaminated soil matrix with minimal forced migration of the contamination outside of the treatment area.

Low soil permeability is a barrier to all forms of remediation. Ozone can be used to take advantage of the much higher gas-phase permeability. Transport properties can also be enhanced by soil fracturing, thereby increasing secondary porosity. This approach may result in the use of fewer injection points. However, each site must be evaluated adequately to ensure that the fracturing does not preferentially bypass contaminated zones or provide a path to enable contaminant migration.

Hydration of the unsaturated zone soils may be required when applying ISCO in the vadose zone because water is the reaction medium for chemical oxidation. This requirement does not necessarily apply to ozone, but hydroxyl radical formation may be increased in the presence of water. Techniques to hydrate the site include injection of large quantities of oxidant to saturate and maintain saturation during the treatment period, artificial hydration of the treatment area, and use of surfactants. The "overinjection of oxidant" approach is generally inefficient and has the potential to enhance the release and migration of the target contaminants. If treatment occurs near the saturated zone of the site without an impervious layer between the vadose zone and the saturated zone, there is a tendency to mobilize both contaminants and products of the reaction. Hydration with wells or infiltration galleries is generally effective and is less likely to mobilize contaminants due to the low hydration pressures and saturation rates. Contaminant location, infiltration rates, and soil permeability are important variables that must be considered.

## **2. SITE CHARACTERIZATION AND CONCEPTUAL SITE MODEL**

To properly design and implement ISCO, a site must be adequately characterized. In fact, the completion of thorough site characterization is the most important factor in the success of any remediation project. Adequate site characterization entails more than simply measuring contaminant concentrations. It also includes determination of the nature and mass of the contaminants present

(sorbed, dissolved, and/or free-product phases), an understanding of the subsurface geology including the identification of the major migration pathways for the COCs, and the direction/gradient of groundwater flow. A conceptual site model should be created that incorporates all of these parameters as an ongoing process for all successful remediation projects. Important features of a conceptual site model include the above-mentioned site characterization parameters, as well as site topography, aquifer geochemistry, the presence of surface and subsurface structures and/or underground utilities, surface water features/uses, and potential receptors in the area. When developing a conceptual site model, all sources of existing information should be researched, including facility permits and licenses, operating records, waste disposal records, interviews, site reconnaissance maps, aerial photographs, and previous environmental/engineering reports.

In completing the site characterization, a thorough sampling and analysis plan based on specific data quality objectives (DQOs) should be developed for the site according to U.S. Environmental Protection Agency (EPA) requirements and/or specific state regulations. Consult the ITRC Web site ([www.itrcweb.org](http://www.itrcweb.org)) for other appropriate guidance documents concerning site characterization procedures, including accelerated site characterization guidance (ITRC publications ASC-1 to ASC-4) and *An Introduction to Characterizing Sites Contaminated with DNAPLs* (ITRC's DNAPLs-4).

## **2.1 Specific Geologic and Chemical Data Needs**

Site-specific geochemical data should be collected to establish baseline conditions prior to treatment, determine oxidant dosage, and evaluate the effectiveness of ISCO treatment. Baseline conditions should be established, including the measurement of initial contaminant concentrations and field water quality parameters prior to treatment using ISCO. Geologic and chemical field data that should be measured as part of the development of a conceptual site model are discussed below.

### **2.1.1 Hydrogeologic Data**

Delineation of the lithology and characterization of the subsurface soils are the initial steps in the development of a conceptual site model. This process includes the collection of detailed lithologic logs from borings drilled at the site, as well as the determination of hydrogeologic data, including hydraulic conductivity/permeability, particle size distribution, soil porosity, and the groundwater flow direction and gradient. It is extremely important to delineate heterogeneous soils and determine the presence of preferential flow paths, if any, to determine the major contaminant migration pathways as well as to understand the ultimate fate of oxidants injected into the subsurface.

Hydraulic conductivity is a measure of the ease by which water can move through the saturated zone of the subsurface geologic media. This measurement helps us understand how easily and how fast both the dissolved-phase contamination and the injected oxidant can move. Hydraulic conductivity can be determined via geotechnical laboratory testing using ASTM Method D5084 or by aquifer testing. Because of subsurface heterogeneity and the difficulty of obtaining an undisturbed sample that is representative of the subsurface environment, field aquifer testing can result in a better evaluation of site-specific conditions than laboratory hydraulic conductivity tests. Hydraulic conductivity is important for estimating a zone of influence, determining the spacing of wells



required to achieve optimal distribution of the injected oxidant, and minimizing forced migration of the contamination (displacement of contaminated groundwater) during injections.

Another parameter similar to the hydraulic conductivity is soil permeability. Permeability is the measure of the ease of which *any* fluid travels through the subsurface materials. It is a property of the soil matrix only and does not take into account any properties of the fluid. Permeability can be determined for either the saturated or the unsaturated zone. It is determined via geotechnical laboratory testing using API Method RP40. Saturated zone permeability is useful to understand the potential migration of free-phase (LNAPL or DNAPL) and dissolved-phase contamination as well as to determine the volume/pressure required to evenly distribute the injected oxidant. Unsaturated zone (air) permeability is useful for ozone projects to determine air flow patterns in the vadose zone.

Particle size distribution is determined via geotechnical laboratory testing using ASTM Method D4464M. This is a quantitative determination of soil particle sizes, including the percent gravel, sand, silt, and clay of a sample. Boring logs may be used to qualitatively evaluate the variation and heterogeneity in soil types, but soil should be tested for particle size analysis to confirm (support) the soil type determination, especially in the source area. The soil type and heterogeneity greatly influences the dispersion of an oxidant. This measurement is comparable to the aforementioned hydraulic conductivity/permeability in the development of the conceptual site model.

Soil porosity (total porosity and effective porosity) is determined via geotechnical laboratory testing using API Method RP40 or ASTM D425M. It is a measure of the void space present in the soil. Soil porosity is necessary to estimate the required injection volume to achieve the desired radius of influence. However, it should be noted that in fine-grained soils much of the void space can be considered to be dead end pores from which water will not drain. Therefore, a more accurate measure of porosity in fine-grained soils is the effective, or drainage, porosity. The effective soil porosity may also be estimated based on aquifer testing conducted to determine the hydraulic conductivity.

The hydraulic gradient is determined by collecting groundwater level measurements from a number of surveyed reference points, usually monitoring wells or piezometers (at least three measurements are necessary). The hydraulic gradient is necessary for estimation of groundwater flow direction and velocity. Properly evaluated hydrogeologic data allows for a more complete understanding of the physical setting of the site. It should be noted that in situations where the subsurface geology is not very permeable (i.e., silts and clays), the presence of manmade conduits, whether current or historic, (sewer, storm, gas, electric, and water lines, improperly abandoned boreholes) may create or contribute to contaminant migration pathways in the subsurface and should be thoroughly evaluated prior to implementing an ISCO remediation project. These conduits can provide a pathway not only for the contamination, but also for the oxidant and/or the products of the reaction. Volatilized (gas-phase) organics can move into the conduit, through the utility fill, or along the buried conduit, creating a potentially explosive atmosphere. Care should be made to locate and monitor these structures during the treatment program to ensure that the conduit atmosphere is maintained at a nonexplosive level. In addition, when working in enclosed environments such as basements, the area should be monitored and ventilated, and all ignition sources (pilot lights, blower motors, etc.) extinguished during the treatment period.

### 2.1.2 Contaminants and Chemical Data

The most common COCs for ISCO projects are measured via laboratory testing using specific EPA methods. The COC concentrations are essential for estimating contaminant mass/location as well as determining baseline levels (preinjection) and evaluating treatment effectiveness (post-injection). EPA methods for some common COCs are summarized below:

<b>EPA method:</b>	<b>Analytical parameters/instrument:</b>
8015B	Nonhalogenated organics (TPH) by gas chromatograph (GC)/flame ionization detector (FID)
8081A	Organochlorine pesticides by GC
8082	PCBs by GC
8260B	VOCs by GC/mass spectrometer (MS)
8270C	Semivolative organic compounds by GC/MS
8310	PAHs by high-performance liquid chromatography (HPLC)
8330	Nitroaromatics and nitramines by HPLC

Laboratory analysis of all the above organic compounds should be performed at least once during the site characterization to determine whether any nontarget COCs are present at levels which may require additional treatment. ISCO is a nonspecific treatment process that will act on any organic contaminants present (see Table 1-6), so it is important to delineate all contamination present in the subsurface. The contaminant mass is determined empirically from measured COC concentrations. The estimation of contaminant mass (in pounds) should include a full lateral and vertical assessment of the saturated zone (including any free-phase product) and the smear zone. Both the dissolved and sorbed phases of contamination should be included in the mass estimation. Collection of soil samples below the water table is critically important in the determination of the sorbed-phase COCs. It is essential to know the mass/location of all contaminants present in the subsurface (within practical limitations) to design an optimal injection system. This estimation is essential when determining oxidant dosing and for placement of an appropriate number of oxidant injection points (or wells). Because chemical oxidants attack the sorbed phase of contaminants as well as the dissolved phase, it is extremely important to include investigation of the sorbed contaminant mass as part of the site characterization. As the oxidant attacks the sorbed mass, the contaminants will be released into the dissolved phase. Therefore, source areas must be adequately delineated to estimate the entire mass present (both sorbed and dissolved). One of the measuring sticks used in determination of the success of chemical oxidation is the net reduction in mass of the contaminant of concern, including all phases.

In all ISCO projects it is important to know what metals are present in the soil and groundwater because this treatment technology can oxidize some metals, including iron, chromium, and selenium, to a more soluble form, thereby increasing their migration potential. This process also creates an additional demand for the oxidant. Knowing which metals are present will aid in the selection of metals that should be monitored throughout the injection and the amount of additional demand for the oxidant. Metals concentrations are determined via laboratory testing using EPA Method 6010B or 200.7 Series. The initial investigation should include the following metals at a minimum: arsenic, barium, cadmium, chromium, copper, iron, lead, and selenium. In addition, hexavalent chromium

should be tested using EPA Method 7199, since chromium<sup>+3</sup> can be temporarily converted to chromium<sup>+6</sup> under oxidizing conditions.

A general minerals analysis includes total dissolved solids (TDS), major anions (chloride, sulfate, nitrate, fluoride), and major cations (calcium, sodium, magnesium, potassium, manganese). It is determined via laboratory testing using EPA Method 300.0 (for anions), EPA Method 6010B (for cations), and EPA Method 160.1 (for TDS). These analyses are useful to determine baseline levels and to track changes in mineral composition due to oxidant treatment.

The number of remediation sites where multiple remediation technologies have been, or are being, deployed sequentially or simultaneously (by design or otherwise) is growing rapidly. Application of most remediation technology classes, ISCO included, involves the temporary or permanent alteration of subsurface conditions. If an ISCO technology is being considered for application at a site after other technologies have been or are to be used, it is appropriate to evaluate the potential impacts the other technologies may have on ISCO technology effectiveness. For example, chemical flooding and enhanced bioremediation technologies involve the introduction of chemicals and/or the promotion of biomass growth that may increase oxidant demand. Chemical flooding technologies include surfactant/cosolvent-enhanced aquifer remediation technologies. Enhanced bioremediation technologies are centered on introduction of labile carbon sources and nutrients, which, if used efficiently, can result in increased biological growth. All of these introduced compounds may result in significant oxidant demand. After injection, these chemicals are often recovered from the subsurface or biodegrade very rapidly, but some amount of the injected chemicals usually remains in situ. The remaining mass of chemicals may exert a significant oxidant load above and beyond natural oxidant demand, alter the redox state, or modify the nature of the contamination. Where biological growth has been stimulated, significant organic carbon increase may be observed, and this must also be considered in evaluating the feasibility or performing the detailed design.

Quantification of the potential impacts of other remediation technologies on ISCO effectiveness may be supported by collecting and sending in specific samples for laboratory analytical and bench-scale tests prior to completing the ISCO feasibility analysis or design. The types of analytical tests will vary depending on the chemicals known or suspected of being utilized previously or expected to be used, the type of oxidant potentially to be used, and the local geology/geochemistry.

### 2.1.3 Oxidizable Matter

Oxidizable matter refers to those naturally occurring organic and inorganic compounds in soil and groundwater that will react with an oxidant. The purpose of analyzing a sample for oxidizable matter is to help determine the natural “oxidant demand.” Laboratory tests are performed on soil and groundwater samples to estimate the concentration of oxidant that will be consumed by both the contaminants and the natural reducing agents during a given treatment time. Results obtained from these tests are used to estimate oxidant dosage requirements. In the subsurface, the oxidant attacks the naturally occurring organics and inorganics as easily as it does the organic COCs. Experience has shown that the rate and degree of degradation of compounds such as TCE and PCE increase with increasing concentrations of oxidant above the natural oxidant demand (NOD). The oxidizable matter present in the subsurface can be measured using several different methods. The most common methods were developed by bench-scale testing and are described below.

“Natural oxidant demand” refers to the consumption of an oxidant due to reactions that are unrelated to degradation of the COC and is usually measured during a bench test. A NOD measurement is a direct estimate of the oxidant consumption by organic and inorganic components in the matrix (soil or water). Such estimation is valuable in determining oxidant dosing. NOD measurement is typically done on uncontaminated samples (background) or samples from which the volatile COCs (VOCs) have been removed. Natural organic matter, also measured with a bench test, is a measure of the oxidant consumption by organic materials in the soil matrix. NOM has a high oxidant demand and therefore can be important when estimating the required chemical dosage. For highly organic soils with high values of NOM, chemical oxidation may not be an economically feasible technology. Soil oxidant demand (SOD) is also measured during a bench test. SOD is a direct determination of the oxidant consumption by both organic and inorganic component of the soil aquifer matrix. A SOD test is typically done with the COCs present in the sample. Not all of the aforementioned tests for organic matter have been standardized. Some are performed under complete mixed conditions while others are flow-through column tests. The amount of time the oxidant is allowed for degradation is another factor that varies. Care should be taken when interpreting the results of these tests as some may overestimate the amount of oxidant needed. Site conditions should be considered when choosing the type of test and interpreting the results.

Other standard laboratory measurements of oxidizable matter in groundwater include the chemical oxidant demand (COD), total organic carbon (TOC), and total inorganic carbon (TIC). COD is determined via laboratory testing using EPA Method 410.4. It is a common groundwater measurement used to estimate the organic pollution load in groundwater. It may be used as a general tool for estimating oxidant dosing. COD values would incorporate the oxidation potential of groundwater, including the oxidant demand imposed by dissolved/suspended oxidizable material and therefore can be a useful indicator of oxidant demand. COD does not include the demand from the soil itself and therefore is of limited value for design of ISCO systems. TOC is determined via laboratory testing using EPA Method 415.1. TOC is a measurement of the organic content of the groundwater and basically represents the NOM present. TIC, a measurement of the total inorganic carbon, and is a potential issue in limestone aquifers and in areas where coal has been handled, mined, or processed. Inorganics can potentially have a large impact on the effectiveness of any treatment due to their absorptive properties (absorbs the contaminants), high oxidant demand, and reactivity with peroxide. Because inorganic carbon is not considered a drinking water pollutant, it does not have an EPA method and must be determined by a British thermal unit (BTU) per pound method and compared to BTU values for coal and petroleum hydrocarbons.

#### 2.1.4 Field-Measured Water Quality Parameters

Measurements of field water quality parameters can be useful in determining an oxidant’s distribution and the effectiveness of the remediation project. Measurements of pH, oxidation reduction potential (redox), dissolved oxygen, dissolved carbon dioxide, temperature, and specific conductance should be taken to establish baseline conditions as well as during and after injection of the oxidant.

The pH of the groundwater can be determined inexpensively by field instrument. Baseline pH values are useful in determining the suitability of an oxidant’s effectiveness, especially for peroxide

injections, which may require a lowered pH to promote the production of hydroxyl radicals. The pH should be measured periodically during treatment to monitor changes. The oxidation reduction potential (ORP or “redox,” sometimes referred to as “Eh”) can also be determined by field instrument. It is a measure of the oxidizing environment and can be used to determine oxidant movement in the field. Positive values of redox reflect oxidizing conditions and generally coincide with the oxidant movement. Dissolved oxygen (DO) is another useful parameter that can be determined by field instruments. The DO content of water is an indicator of its organic pollutant load (i.e., DO decreases with increasing contaminant concentrations). Increases in DO concentrations reflect oxidizing conditions and generally coincide with the oxidant movement. Carbon dioxide is a by-product of the oxidation process and can be an indication of the rate and extent of oxidation at the site. It should be noted that this gas is also produced by carbonate in the formation and should be used for evaluation purposes only. Temperature can also be determined by field instrumentation. Increases in groundwater temperature are often detected immediately after injection of hydrogen peroxide. For safety reasons, downhole temperatures for peroxide projects should be closely monitored and controlled. Conductivity/specific conductance is the last useful parameter determined by field instrument. Slight increases in conductivity are frequently observed following oxidant injections. Conductivity can also be an important parameter to establish baseline conditions and to track the extent of oxidant dispersion. Field-measured parameters are inexpensive to obtain, yet they can add value to the conceptual site model throughout the remediation project. The delineation of the dispersion of the injected oxidant through field water quality measurements is valuable information that can be easily and inexpensively obtained.

#### 2.1.5 Additional Data Needs for Permanganate

Permanganate treatment requires the collection of additional data to aid in the design of an injection project. Manganese groundwater concentration is determined via laboratory testing using EPA Method 6010B. Background measurements of manganese concentration should be collected to establish existing conditions prior to injection of permanganate. The potential for manganese dioxide precipitation and clogging of aquifer pore space should also be evaluated. In addition to the potential to mobilize metals, some of the commercially available potassium permanganate products already contain elevated levels of metal impurities (e.g., chromium). Therefore, metal concentrations in groundwater should be monitored throughout the remediation project. Permanganate concentrations can be measured by colorimetry using a spectrophotometer. This approach allows potential real-time field collection of permanganate concentration data that is valuable in determining permanganate distribution in the subsurface.

#### 2.1.6 Additional Data Needs for Persulfate

Persulfate treatment also requires additional data collection to aid in the design of the injection. Sulfate levels in the groundwater should be monitored throughout the remediation project. Sulfate concentrations are determined via laboratory testing using EPA Method 300.0. Background measurements of sulfate concentration should be collected to establish existing conditions prior to injection of persulfate.

If there is adequate iron in the soil matrix, it may not need to be added per se but may be released by acid addition or a chelant. Total iron content is determined via laboratory testing using EPA Method

6010B or 200.7. These are measurements of the total iron present, not the available iron necessary for persulfate activation [Fe(II)]. This iron must be converted to Fe(II) before it can be used to activate persulfate. The baseline iron content in the groundwater should be factored in to estimate the iron dosing requirements for persulfate injections. Similar to peroxide reactions, persulfate treatment requires a baseline iron content to properly dose (and not overdose) the groundwater. Overdosing of iron can reduce the aquifer permeability due to formation of iron oxides and also contribute to radical termination reactions. Bench tests are suitable for determining this parameter and a pilot test in the field to confirm.

#### 2.1.7 Additional Data Needs for Peroxide

Peroxide treatment also requires additional data collection to aid in the design of an injection program and to establish an adequate monitoring program. The baseline iron content in the groundwater should be factored in to estimate the iron dosing requirements for peroxide injections. A high baseline iron content could cause the overdosing of iron, which may result in reducing the aquifer permeability (due to formation of iron oxides) and increase radical termination reactions. Iron content can be determined via laboratory testing using EPA Method 6010B.

Another important parameter, alkalinity, is determined via laboratory testing using EPA 310.1. In general, alkalinity is a measure of the carbonate and bicarbonate concentrations in water. Alkalinity measurements help determine the amount of acid required to reduce the pH level for Fenton's injections. Hydroxyl radicals are also reportedly scavenged in the presence of highly alkaline water. Therefore, estimates of peroxide dosage need to account for the presence of alkalinity.

Field-measured parameters can be inexpensive but can also be extremely valuable to ensure a safe environment when injecting peroxide. Temperature increases in groundwater are often detected immediately after injection, and for safety reasons downhole temperatures should be closely monitored. Oxygen gas can also be determined by field instrument. Off-gases emanating from the injection well casing often contain elevated oxygen levels due to the generation of oxygen that occurs during peroxide reactions. Carbon dioxide can also be determined by field instrument or via laboratory testing using Standard Method 4500-CO2D. Carbon dioxide emissions often increase following injection of hydrogen peroxide and ozone oxidants. The lower explosive limit (LEL) is another important measurement determined by field instrument. If anthropogenic features exist in close proximity to the site, the indoor air of buildings and/or manmade conduits should be screened for the presence of explosive gases before and during chemical dosage. These measurements help establish baseline conditions and monitor migration of explosive gases.

#### 2.1.8 Additional Data Needs for Ozone

Ozone treatment projects often require additional data needs focused on the permeability and chemical content of site soils. The three most critical data needs are the determination of soil permeability, moisture content, and determination of the NOD as ozone by standard methods. The measurement of specific field parameters, such as oxygen, carbon dioxide, and LEL, are also useful in establishing a safe monitoring program.

Permeability is determined via geotechnical laboratory testing using API Method RP40 and/or a field pilot study using SVE-radius of influence (ROI) analysis or a standard pump test. Soil permeability is required to determine dispersion of ozone through site soils (both saturated and vadose zone) and for spacing of ozone injection points. Soil moisture content is determined via geotechnical laboratory testing using ASTM Method D2216. Moisture content is important in ozone injections since it has been reported that the dispersion of ozone gas is reduced with increase in soil moisture. The presence of high moisture content reduces the air-filled porosity and therefore restricts advective flow of ozone gas to the contaminated zone. Soil moisture can be easily reduced by application of SVE prior to, or simultaneously with, zone injection. Carbon dioxide is measured by field instrument or via laboratory testing using Standard Method 4500-CO2D. Carbon dioxide emissions often increase following injection of ozone. Oxygen and ozone gases are also measured by field instrument. Off-gases often contain elevated oxygen levels due to the generation of oxygen that occurs during an ozone reaction. Similar to Fenton's injections, LEL should also be measured during ozone injections. These measurements help establish baseline conditions and monitor migration of explosive gases. Gases are commonly monitored at the wellhead, sensitive receptors, and utility vaults.

#### 2.1.9 Additional Data Needs for Supporting Microbial Benefits

Measurement of the aerobic microbial benefits of ISCO focuses on the post-oxidative effects of enhancing biological removal of a chemical COC. In many cases this post-oxidative effect acts as a "polishing" step to help bring contaminants below risk-based concentrations, although it can also be a primary method for reducing overall contaminant mass. When biologically based MNA or enhanced passive remediation (EPR) is part of a remediation design (as with the oxidants of ozone, peroxide, persulfate, or Fenton's reagent, followed by aerobic biological reduction of residual organic contaminants), there are additional pre-, post-, and in-process analytical parameters of interest that should be measured and recorded, including the following:

##### *Groundwater parameters:*

- dissolved organic carbon (DOC)
- alkalinity
- orthophosphates
- total (Kjeldahl) nitrogen
- Nitrogen as Nitrate
- total phosphorus
- dissolved contaminant (e.g., BTEX)
- ORP
- pH
- DO

##### *Soil parameters:*

- phospholipid fatty acids (PLFA)
- heterotrophic plate counts (or other method of identifying microbes)
- foc (fraction of soil that is organic carbon)
- contaminant (e.g., chloroethenes)
- NOD

Measurement of the anaerobic microbial benefits of ISCO focuses on the post-oxidative effects of enhancing biological reductive dechlorination (e.g., halorespiration) of the chemical contaminant of concern. In many cases this post-oxidative effect acts as a “polishing” step to help bring contaminants below risk-based concentrations. The aquifer commonly reverts to preinjection conditions within six months after the oxidant is consumed, which in many cases is an anoxic environment. The reduction of contaminant levels and the production of intermediates more biodegradable can enhance anaerobic degradation in the post-oxidation environment.

When biologically based MNA or EPR is part of a remediation design (as with permanganate oxidation of chloroethenes followed by *Dehalococcoides ethenogenes* reduction of residual chloroethenes), there are additional pre-, post-, and in-process analytical parameters of interest that should be measured and recorded, including the following:

*Groundwater parameters:*

- chloride (field and/or lab)
- bacterial substrate (e.g., ethanol)
- DOC
- alkalinity
- fluoride tracer (field and/or lab)
- orthophosphates
- total (Kjeldahl) nitrogen
- nitrogen as nitrate
- total phosphorus
- dissolved contaminant (e.g., chloroethenes)
- ORP
- pH
- DO

*Soil parameters:*

- PLFA
- polymerase chain reaction (enzymes such as TCE reductase, VC reductase)
- Dehalococcoides ethenogenes* (or other microbes of interest)
- foc
- contaminant (e.g., chloroethenes)
- NOD (e.g., permanganate demand)

## 2.2 Screening Tools for Site Characterization

There have been many advances in site characterization technologies in recent years. Many of these technologies can result in valuable information acquired at a lower cost. This section outlines some of the technologies useful for screening sites for potential ISCO applications.



### 2.2.1 Direct-Push Technologies

Direct-push technology has been used to provide a rapid and low-cost screening tool to provide valuable subsurface data for site characterization. One of the greatest advantages of using direct-push technology is the elimination of soil cuttings generated with normal hollow-stem auger drilling. The two most common direct-push technologies are discussed below.

A Geoprobe<sup>®</sup> is a hydraulically powered rig used to drive a small-diameter (typically 3/4- to 2-inch-diameter) probe for collection of subsurface samples. A powerful combination of hydraulic force and percussion hammer is used to provide up to 18,000 pounds of downward force. A soil penetration rate of 5–20 feet per minute can be accomplished. Depending on soil type, the Geoprobe can be commonly driven to a maximum depth of approximately 30–60 feet below ground surface (bgs). Geoprobe rigs are capable of collecting soil, soil gas, and groundwater samples at discrete depths or at continuous intervals if needed. To provide access to hard-to-reach locations, Geoprobe rigs can be mounted on many types of vehicles, including four-wheel-drive trucks, all-terrain vehicles, tractors, golf carts, track-powered units, and skid-mounted rigs.

Cone penetrometer testing (CPT) is a direct-push technology that typically uses a much larger (up to 25-ton) rig to drive a stainless steel cone for collection of both lithologic data and subsurface samples. A piezocone is an electronic device used to continuously measure tip and sleeve resistance, pore pressure, and electrical conductivity with depth. These data are plotted and interpreted to provide a continuous stratigraphic profile of soil behavior and types. This technique allows for early identification of specific soil zones of concern, which then can be sampled for laboratory testing using conventional techniques. CPT combined with a rapid optical screening tool or a membrane interface probe (MIP) attachment can quickly and easily delineate lithology and contaminant levels with depth.

### 2.2.2 Rapid Optical Screening Tool

The rapid optical screening tool (ROST) can be used in conjunction with either a Geoprobe or a CPT rig to provide a qualitative profile of petroleum hydrocarbons with depth. Petroleum hydrocarbons are characterized in real time from the fluorescence response induced in the PAHs present in the soil. Laser-induced fluorescence spectroscopy is used in the tip of the probe to excite the petroleum hydrocarbons that are encountered with depth. The intensity and duration of the fluorescence as well as the spectrum of wavelengths of light emitted by the petroleum hydrocarbons are continuously recorded. In some cases, a determination of the type of petroleum hydrocarbon present (gasoline, diesel, jet fuel, or creosote) is possible by comparing the waveform signatures of common petroleum products to the ROST results. The benefit of using ROST technology is the ability to screen several hundred feet of soil in a single day. The actual depth of ROST sampling depends on soil type. ROST results can be plotted on a three-dimensional map, and locations can then be selected to collect samples for analytical testing and confirmation. Targeted soil sampling can then be performed on a select number of samples to reduce overall analytical costs.

### 2.2.3 Membrane Interface Probe

The membrane interface probe is similar to ROST in that it can be used with either a Geoprobe or a CPT rig; however, the MIP can detect all types of organic constituents in the soil, not just petroleum hydrocarbons. The MIP probe is 1.5 inches in diameter and approximately 12 inches long. As the probe is advanced, a polymer membrane allows VOCs to diffuse inside the probe. The membrane is heated (80–125°C), causing the VOCs to partition into a carrier gas, which is returned to the surface where three detectors (FID, photoionization detector, and electron capture detector) are used to measure concentrations of the VOCs. The MIP can also measure soil conductivity, which is useful in identification of sands (lower conductivities) and silts and clays (higher conductivities). The MIP can continuously detect both contaminant levels and lithology, but because the sensitivity of MIP is limited (common detection limits are 100 µg/L), it should be used primarily for areas of high contamination (source areas). This technology can be used to characterize contaminant mass in source areas and support geologic data collected at the site. MIP data in conjunction with groundwater flow direction can be used to quickly locate additional downgradient monitoring wells. MIP data can also ensure the oxidant injection design has targeted the contaminant mass and taken into consideration the permeability of the injection zones.

### 2.2.4 Partitioning Interwell Tracer Test

Typically, when NAPL (either LNAPL or DNAPL) is present at a contaminated site, the vast majority of the anthropogenic organic contamination is present in the NAPL phase. It is imperative that the presence of NAPL be ruled out or confirmed as part of an effective site characterization effort. If NAPL is confirmed, the location, composition, total mass, and typical pore saturation levels should be estimated accurately to support an effective feasibility evaluation, design, and application with respect to ISCO. A number of site characterization technologies may be applicable for investigating NAPL at a given site. An effective site characterization design will incorporate multiple technologies as there is no one technology that can accurately determine NAPL presence, location, composition, total mass, and typical pore saturation levels. For example, certain technologies may be effective in relatively permeable subsurface environments, while others are somewhat effective in low-permeability settings. Also, certain technologies rely on the information obtained from more basic tests as input to operate at a higher level of complexity with the intended outcome of obtaining a more detailed understanding of subsurface NAPL conditions.

The partitioning interwell tracer test (PITT) is specifically directed at detection and quantification of NAPL. Unlike the screening tools (some discussed herein), contamination in the dissolved and sorbed phases do not interfere with the PITT. Also unlike these other tools, the PITT can be used to confirm the presence of NAPL, identify the location(s) of NAPL, and estimate the total volume or mass and average saturations of NAPL. To achieve these ends, a limited amount of site characterization data must be available on the geology, geochemistry, and contamination from soil borings; sampling and analysis of soils; and if possible any NAPL encountered. Hydraulic conductivity should be on the order of  $10^{-4}$  cm/sec or greater. A PITT can be conducted in the vadose zone or the saturated zone and involves the establishment of a forced-gradient flow field and the injection and recovery of a suite of tracers into and then out of the forced-gradient flow field. The forced-gradient flow field is established by injecting and extracting air-soil gas (for vadose zone) or potable water-groundwater (for saturated zone) using wells at constant flow rates over a

period of days. The wells may be existing wells but are often specifically located and designed to support the PITT. A suite of at least two tracers is used: one must be a conservative tracer relative to the NAPL, and the other must be a partitioning tracer relative to the NAPL. Often, three to five tracers are used to improve accuracy and in the case of vadose zone PITTs to estimate average water saturation as well. Partitioning coefficients for the tracers and NAPL (and water in some cases) are determined in the laboratory and, together with tracer break-through curves developed through on-site sampling and analysis of recovery well effluent, the total volume and average saturation of NAPL in the swept pore volume can be calculated. Multilevel samplers in boreholes or individual clustered sampling points are often used as observation and sampling points within the swept pore volume, and with these point estimates of NAPL presence and pore saturation are possible. One of the key advantages associated with a site characterization strategy that includes the PITT is the high-quality information that is produced on not only NAPL but also subsurface hydraulics. Remedial planning can be greatly accelerated using PITT. In addition, with proper foresight and planning, the PITT can be used in a performance assessment mode in which a PITT is performed before remediation and then (using the same wells) after some period of remediation to evaluate the effectiveness of the remedial effort in removing or destroying the NAPL.

### 3. HEALTH AND SAFETY ISSUES

Hydrogen peroxide, potassium permanganate, and sodium persulfate are relatively safe chemicals when handled and stored according to the manufacturers' guidelines. However, as with the handling and storage of any oxidizing chemical, appropriate care should be taken, and the material safety data sheets (MSDSs) always consulted prior to use. Skin and eye contact with oxidizing chemicals should be avoided, and special care should be taken to avoid breathing the chemicals in the form of dust or mist. Consequently, proper personal protective equipment should be employed per the MSDS. Also, oxidizing chemicals should never be stored or directly mixed with combustible materials (such as fuels, paper, or solvents) or reducing agents (such as metals or sulfites). Oxidizing chemicals may not only react energetically with combustible materials or reducing agents but also release oxygen and heat during decomposition that could help support a fire. Additionally, some oxidizing agents are incompatible with one another. For example, potassium permanganate should never be mixed with concentrated hydrogen peroxide because the former acts as a reducing agent (1.44 V), the latter acts as an oxidizing agent (1.77 V), and a rapid and energetic reaction ensues. Product labeling typically warns against these dangers. Complete familiarization with the safe handling and storage practices of these oxidants and proper use of personal protective equipment are strongly recommended to avoid incident or injury. National Fire Prevention Association guidelines should be followed when storing significant quantities of an oxidizer.

The primary route of toxicity associated with oxidizing chemicals is through direct inhalation of the chemicals; however, exposure may be irritating to the eyes and skin upon contact. Inhalation of hydrogen peroxide mist, potassium permanganate dust, or sodium persulfate particulates can irritate the respiratory tract. Inhalation of large quantities of permanganate dust can result in pulmonary edema, which could develop several hours to several days after the exposure and possibly result in death. (Note: This is highly unlikely for use in environmental remediation applications.) Exposure to high levels of persulfate dust may cause difficulty in breathing in sensitive persons. Since the above oxidizing chemicals are not volatile, inhalation of the chemicals could only occur if the chemicals

were handled in a manner that would create airborne mist or dust. Workers should therefore handle the chemicals in a manner that minimizes the creation of mist or dust. Proper respiratory, eye, face, and skin protection should always be worn when working directly with these chemicals. Once the chemicals are placed into solution or into the subsurface, exposure to the chemicals through inhalation pathways is very unlikely. Therefore, the threat of toxic exposure is primarily limited to those individuals working directly with the chemical in solid form. The life span of the above oxidizing chemicals is short after the chemicals are introduced into the subsurface for in situ oxidation. For example, the life span of hydrogen peroxide may last from several hours up to several days before it is completely decomposed. Persulfate may be stable for several days to weeks. Potassium permanganate, on the other hand, may remain in the subsurface for several months, depending on the organic content and mineral composition of the soils. Once reacted, the threat of toxic exposure of the aforementioned oxidizers is eliminated since the by-products of their decomposition reactions are considered safe and nontoxic.

None of these oxidizers themselves are flammable; however, they increase either heat or oxygen or both in the surrounding environment when in contact with oxidizable materials or reducing agents, increasing the potential for fire. In addition, hydrogen peroxide can undergo self-accelerating decomposition when in contact with metals or combustible compounds at elevated temperatures. During decomposition, hydrogen peroxide releases heat and oxygen gas that can create an explosive environment both in situ and in confined spaces. The amount of heat and gas that is released is directly related to the rate of decomposition of the peroxide and the amount of organics/catalytic inorganics in the treatment area. The rate of hydrogen peroxide decomposition can be controlled by using a lower-concentration hydrogen peroxide and by controlling the application of the peroxide. This control can be accomplished by using restricted flow, low concentrations of peroxide (<17.5%), low pressures (<5 psig), low temperatures (<140°F), and/or stabilizers/inhibitors. The control of the reaction rate can be determined only by the in situ real-time measurements of temperature, pressures, and gas generation. When higher concentrations of hydrogen peroxide are used, the exothermic decomposition of the peroxide generates heat, water vapor, and oxygen that tend to volatilize contaminants from the soil and/or groundwater. This rapid decomposition reaction could foreseeably create an explosive condition if used for treatment of flammable or combustible compounds due to the resulting mixture of heat, oxygen, and flammable compound. EPA has advised caution before approving the use of hydrogen peroxide for in situ chemical oxidation of flammable compounds such as for gasoline remediation. One such project conducted at an underground storage tank (UST) site in Cherry Point, North Carolina resulted in buckling of an asphalt parking lot and a subsequent fire and explosion. This event illustrates the potential danger of using high-strength peroxide for in situ remediation applications.

Potassium permanganate decomposes via a different mechanism than hydrogen peroxide, so the risks associated with rapid decomposition of permanganate differ from those of hydrogen peroxide. However, fire or explosion risks still exist if an individual or contractor improperly mixes permanganate with combustible or flammable compounds. Examples of such incompatibility include a barn fire that occurred when a farmer mixed formaldehyde and potassium permanganate for fumigation purposes. In another incident, a fire and subsequent plane crash occurred when a crop duster mixed permanganate with elemental sulfur in the crop-dusting bins. A remediation worker recently received thermal burns while working on a permanganate ISCO project at a Department of Energy facility in Piketon, Ohio. In each case, the injured individuals apparently did not possess the

required chemical knowledge or expertise to be working directly with the chemicals. These examples demonstrate why environmental contractors must have adequate safe handling, storage, and use training and knowledge of oxidizing chemicals before implementing ISCO in the field.

Sodium persulfate is a very stable, crystalline material. However, excessive heat or moisture can result in the decomposition of the persulfate. Decomposition should occur within the crystalline material where there is low thermal conductivity, potential examples being at the bottom of a pallet or the center of a drum. The heat generated may induce a self-accelerating decomposition. The resultant oxygen and heat release may result in the combustion of surrounding materials. Thus, sodium persulfate should be stored in a cool, clean, dry place away from point sources of heat (such as radiant heaters) and moisture (such as rain). Contamination of opened product should be avoided, as soils and dirt may contain reducing agents or oxidizable components. In case of fire, deluge with plenty of water to control the decomposition. Aqueous solutions of persulfate can safely be made for injection into the subsurface, as normal aqueous decomposition of persulfate will not lead to excessive heat generation due to the heat capacity of the water. Solutions of sodium persulfate should be used soon after preparation, as the aqueous decomposition of the persulfate leads to the eventual loss in persulfate concentration.

Since ozone is generated on site, handling and transportation concerns do not apply to its use. However, pure ozone is an explosive gas in addition to being an oxidizer. High concentrations (>2 ppm) of ozone can cause irritation or damage to the eyes and respiratory tract. When used for in situ chemical oxidation, ozone is typically mixed with air prior to injection, but nearly pure ozone may be present in the generating apparatus or build up in the enclosure containing the equipment. Therefore, adequate ventilation of this enclosure is necessary, and all ignition sources should be kept away from the equipment.

Potassium permanganate and hydrogen peroxide may cause burns to the skin, eyes, and mucous membranes upon contact. As with all oxidizing chemicals, the severity of the chemical reaction depends on the concentration of the oxidant in solution. The dangers of high-strength peroxide were illustrated earlier, and similar dangers may result from the use of high-strength permanganate solutions. The solubility of potassium permanganate in water is typically limited to 3%–6% (depending on the temperature of the water). This lower concentration of permanganate causes burns to the skin upon prolonged exposure. However, sodium permanganate has a much higher solubility and can therefore cause immediate and severe burns upon contact. Sodium persulfate may cause irritation on contact with the skin and may sensitize certain individuals.

#### **4. REGULATORY BARRIERS**

Since the previous version of this ITRC document was published, some states have modified permitting and variance requirements to become more supportive of the use of innovative treatment technologies (ITTs) like ISCO. As defined in *An Analysis of Barriers to Innovative Treatment Technologies: Summary of Existing Studies and Current Initiatives* (EPA 2000), regulatory and legislative barriers “are imposed by legislature and government agencies through specific statutes, regulations, policies and programs.” Three barriers were consistently mentioned:

- Permitting processes are inconsistent, involve numerous levels, and are time- and resource-intensive.
- Permitting and manifesting requirements under the Resource Conservation and Recovery Act (RCRA) often inhibit the development of ITTs.
- Contractors and others are concerned about financial liabilities they may incur by using ITTs.

Since the most common application of ISCO is aquifer remediation via an injection well, a typical regulatory barrier is the Underground Injection Control (UIC) program of the Safe Drinking Water Act (SDWA). Other possible barriers are RCRA; the Comprehensive Emergency Response, Compensation and Liability Act (CERCLA); and the Emergency Planning and Community Right to Know Act (EPCRA).

Appendix C contains examples of ways states can permit and/or implement ISCO as a soil and groundwater remediation technology. The six regulatory examples— from New Jersey, California, Florida, Kansas, Missouri, and Texas—provide the reader with several different permitting methods from across the United States.

#### **4.1 Safe Drinking Water Act/Underground Injection Control**

Injection wells are regulated by the UIC program under the SDWA. Under the UIC program, injection of any fluid into a well is prohibited except as authorized by permit or rule. State UIC programs may be delegated complete or partial enforcement responsibility (or primacy) by EPA. Injection wells incidental to aquifer remediation and experimental technologies are distinguished from hazardous waste injection wells and are designated as Class V under the UIC program. Class V wells covered by the federal UIC program are authorized by rule and do not require a separate UIC permit, but a Class V well regulated by a state UIC program may require a permit. Specific state requirements are outlined in Table 4-1. The purpose of the UIC program is to protect underground sources of drinking water (USDW) by prohibiting injections that may affect water quality. Contaminated aquifers at Superfund sites may not serve as a USDW, and therefore UIC requirements may not apply to wells at CERCLA sites.

#### **4.2 Resource Conservation and Recovery Act**

ISCO may take place via injection or mixing methods. When mixing occurs ex situ and potential hazardous wastes may be generated, the need for a permit for treatment, storage, and disposal is an issue. Although RCRA remediation staging piles and presently allow for on-site treatment of wastes, the permit requirements for these management plans can be time-consuming and expensive.

#### **4.3 Comprehensive Environmental Response, Compensation and Liability Act**

As part of CERCLA, releases of certain quantities of hazardous chemicals are required to be reported to the National Response Center. In regards to ISCO of contaminated soils, it is likely that the treatment would be considered a “process” rather than a “release” and therefore exempt from CERCLA reporting. It is strongly recommended, however, that the appropriate regulatory agency be contacted prior to the commencement of an ISCO project to make certain that all reporting requirements are satisfied.

**Table 4-1. Regulatory permitting requirements for oxidant injection by state**

State	Chemical oxidant injection	Agency	Permit exceptions
Alabama	UIC permit	ADEM Water and Land Division	None
Alaska	No permit required, must inventory	EPA Region 10	NA
Arizona	No permit required, must inventory	EPA Region 9	NA
Arkansas	No permit required, must inventory	Dept. of Environmental Quality	NA
California	No permit required, must inventory	EPA Region 9	NA
Colorado	No permit required, must inventory	EPA Region 8	NA
Connecticut	UIC permit	Dept. of Environmental Protection	Emergency authorization permit
Delaware	UIC Authorization	Dept. of Natural Resources and Env. Control	NA
Dist of Columbia	No permit required, must inventory	EPA Region 3	NA
Florida	UIC permit	FLDEP Division of Water Resource Management	Injection permit variance
Georgia	UIC permit	GEPD Geologic Survey	None
Hawaii	No permit required, must inventory	EPA Region 9	NA
Idaho	No permit required, need approval	Dept. of Water Resources	NA
Illinois	No permit required, must inventory	Env. Protection Agency Bureau of Land	NA
Indiana	No permit required, must inventory	EPA Region 5	NA
Iowa	No permit required, must inventory	EPA Region 7	NA
Kansas	UIC permit	KDHE Bureau of Water Env Geology Unit	None
Kentucky	No permit required, must inventory	EPA Region 4	NA
Louisiana	UIC permit	LDNR Office of Conservation	None
Maine	License by rule, must inventory	Dept. of Environmental Protection	NA
Maryland	UIC permit	Dept. of the Environment	None
Massachusetts	No permit required, need approval	MADEP Regional Offices	NA
Michigan	No permit required, must inventory	EPA Region 5	NA
Minnesota	No permit required, must inventory	EPA Region 5	NA
Mississippi	No permit required, must inventory	Dept. of Environmental Quality	NA
Missouri	UIC permit	MDNR Water Pollution Control Program	Pilot study exception (<1-year duration)
Montana	No permit required, must inventory	EPA Region 8	NA
Nebraska	UIC permit	Dept. of Environmental Quality	Authorization for pilot study
Nevada	UIC permit	Dept. of Environmental Protection	None
New Hampshire	UIC registration	Dept. of Environmental Services	NA

**Table 4-1. Regulatory permitting requirements for oxidant injection by state (continued)**

<b>State</b>	<b>Chemical oxidant injection</b>	<b>Agency</b>	<b>Permit exceptions</b>
New Jersey	UIC permit	NJDEP Site Remediation Program	Permit-by-rule for 90-day pilot studies
New Mexico	UIC permit	Environment Dept.	Temporary permit for pilot study
New York	No permit required, must inventory	EPA Region 2	NA
North Carolina	UIC permit	Dept. of Env and Nat Resources	None
North Dakota	No permit required, must inventory	Dept. of Health	NA
Ohio	No permit required, need exemption	Ohio EPA	NA
Oklahoma	UIC approval	Dept. of Environmental Quality	NA
Oregon	UIC permit	Dept. of Environmental Quality	Authorization by rule
Pennsylvania	No permit required, must inventory	EPA Region 3	NA
Rhode Island	UIC permit	Dept. of Environmental Management	Approval needed
South Carolina	UIC permit	Dept. of Health and Environmental Control	None
Tennessee	No permit required, must inventory	EPA Region 4	NA
Texas	No permit required, need approval	TCEQ Groundwater Protection Division	NA
Utah	No permit required, must inventory	Dept. of Environmental Quality	NA
Vermont	No permit required, need approval	Dept. of Environmental Conservation	NA
Virginia	No permit required, must inventory	EPA Region 3	NA
Washington	No permit required, need approval	Dept. of Ecology	NA
West Virginia	UIC permit	Division of Environmental Protection	Authorization by rule
Wisconsin	No permit required, need approval	Dept. of Natural Resources	NA
Wyoming	UIC permit	Dept. of Environmental Quality	Department Lead Remediation Project



#### 4.4 Emergency Planning and Community Right-to-Know Act

EPCRA created a national program for emergency planning, notification, and reporting for releases of extremely hazardous or toxic chemicals. There are generally three sections of EPCRA (310, 311, and 312) that apply to ISCO treatment. Section 302 requires facilities to prepare a comprehensive emergency response plan if an extremely hazardous substance will be stored or handled in quantities greater than established limits. For example, if 1,000 pounds or greater of H<sub>2</sub>SO<sub>4</sub> is stored at a facility for in situ Fenton's oxidation, a comprehensive emergency response plan must be prepared. Section 311 requires the submission of MSDS sheets to state and local planning commissions and to fire departments if extremely hazardous substances and/or CERCLA hazardous substances are stored in quantities greater than the established limits. Section 312 requires an emergency and hazardous chemical inventory form to be submitted to state and local planning commissions and to the local fire department for hazardous substances and/or CERCLA hazardous substances stored in quantities greater than the established limits. It should be noted that Section 311 reporting requirements are not much of a burden, whereas Section 312 may not be applicable for most ISCO projects if chemical storage no longer occurs once chemical injection into the subsurface takes place.

#### 4.5 Solutions to Regulatory Barriers

State variances have been granted from the various rules that prohibit "zones of discharge" for injections through remediation wells. Typically, these variances are contingent upon the following:

- A corrective action plan must be approved by the state agency.
- The discharge (of treatment chemicals) must be through a UIC well which meets all of the applicable construction, operating, and monitoring requirements of the state agency.
- The zone of discharge must be acceptable to the state agency, typically a 10-foot radius from the point of injection, but always within the contamination plume.
- The rate and volume of reagent injection must not cause undesirable migration either of the reagents or of contaminants already present in the aquifer.
- The corrective action plan must address groundwater monitoring requirements associated with the use of the technology based on site-specific hydrogeology and conditions.

Some states have implemented modifications to the above rules which allow the discharges without a variance under certain conditions, for example:

- a closed-loop system is proposed in which the reagent is withdrawn from the aquifer and then reinjected with the extracted groundwater and its contaminants that are only partially treated or
- the injected reagent does not contain secondary components that are not chemically involved in the oxidation process which would trigger their own violations of groundwater standards.

Most typical of the latter circumstance are permanganate reagents, which may be accompanied by small quantities of heavy-metal impurities (arsenic, cadmium, chromium, etc.), which are primary drinking water contaminants. If such a reagent is employed, the impurities may call for a UIC variance, or an assay may be requested from the vendor to verify that injection of the reagent will not trigger violation(s) of groundwater standards by the secondary components.

Federal EPA initiatives to reduce regulatory (and legislative) barriers have been implemented, such as the following:

- Since 1992, EPA has been granting states the authority to implement the Treatability Exclusion Rule; the Research, Development, and Demonstration Permit Program; and the Subpart X Permit Program. Those authorities are granted to states to simplify the approval process for technologies and to allow flexibility in testing and demonstrating ITTs.
- To further promote the use of innovative technologies, in 1994 EPA revised its Treatability Study Sample Exclusion Rule (59 Federal Register [F.R.] 8362) to allow treatability studies on up to 10,000 kg of media contaminated with nonacute hazardous waste without the requirement for permitting and manifesting.
- In addition, EPA encouraged streamlining RCRA permits and orders for ITT development and use and encouraged state adoption and streamlining of EPA authorization to administer the treatment study sample exclusion rule.
- In 1993, EPA issued the Superfund Response Action Contractor Indemnification Rule (58 F.R. 5972), designed to help contractors who use ITTs obtain lower deductibles on liability insurance.
- EPA's area of contamination (AOC) policy allows soils to be excavated, moved, treated and redeposited within the AOC without triggering RCRA regulatory requirements.

Individual state regulations may be more restrictive than the above-mentioned EPA requirements. Thus, individual state regulations must always be reviewed.

## **5. APPLICATION DESIGN**

This section describes the theoretical and practical issues related to field application and design processes of in situ oxidation technologies. It uses theoretical knowledge gathered in the laboratory as well as the practical experience obtained in the field. The discussion provided herein generally applies to all in situ oxidation technologies, but unique considerations for specific oxidants are presented separately where applicable.

### **5.1 Laboratory Treatability Studies**

For most ISCO applications, laboratory-scale testing is performed to ensure successful full-scale implementation. Laboratory-scale testing is used to quantify treatment efficiencies of chemical oxidants with specific contaminants in both saturated soil and the dissolved phase. It can also be used to evaluate the oxidant demand due to the soil matrix and the potential for metals mobilization in cases where soil metals concentrations are high.

The results of laboratory-scale testing of an ISCO technology may or may not be directly (linearly) applied to the design of a corresponding pilot-scale study. Nonlinear scaling up of the results from a small scale to a larger scale may be required. Laboratory scale results are often based on extremely small volumes of disturbed soil and/or groundwater relative to the actual volume that requires treatment. The test apparatus often does not adequately recreate the geometric nature or flow characteristics of the physical system observed in the field. For example, one-dimensional columns and two-dimensional batch reactors are often used as convenient means to simulate the three-

dimensional environment. Test boundary conditions (e.g., wall effects) that are not present in the field can become important in the laboratory test. Also, laboratory-scale tests often are based on well-mixed static systems, while the field implementation involves more heterogeneous flow. Nonetheless, laboratory-scale tests are essential for estimating site-specific oxidant demand due to the soil matrix.

The difficulty in using bench-scale studies to estimate field-scale oxidant demands may be explained by the high degree of subsurface heterogeneity and the oxidant demand testing protocol. At the site scale, lithologic heterogeneity implies a similar degree of heterogeneity of the oxidant demands, since oxidant demand is primarily a function of geochemical properties of the soil, including organic carbon content and the presence of reduced mineral phases. Little is understood about this phenomenon with respect to persulfate, Fenton's reagent, or ozone. In the case of permanganate, the slow reaction kinetics of this relatively stable oxidant typically lead to overestimates of the actual oxidant demand because of the complete mix conditions present in bench-scale studies but not present in situ.

## 5.2 Pilot-Scale Studies

Pilot studies provide the necessary information to perform a full-scale design, including determining appropriate injection well/point spacing and determining appropriate injection flow rates for liquid and or gas delivery and to compare various oxidation approaches. Pilot testing is also performed to determine injection parameters required to estimate full-scale remediation costs. These parameters include oxidant concentrations, injection rates, temperature, pressures, radius of influence, and injection volumes. Pilot-scale testing can also be used to confirm complex subsurface geologic formations and to determine treatment effectiveness for COCs. These tests are actually full-scale remediation performed at a small area of the site. Before performing any pilot-scale testing, it is important that all stakeholders have a realistic expectation of how the pilot-scale test results will be used to support full-scale remediation design.

General technical considerations that should be addressed in planning for pilot-scale testing of ISCO technologies are outlined below:

- Perform the on-site pilot test in a location that is most representative of site conditions. This is normally a smaller contaminated portion of the site in an area that will allow for uninterrupted operation. If the entire plume will not be treated in the pilot test, it is important to choose a side-gradient portion of the contaminant plume, if practical, to ensure that treated areas will not be recontaminated and to enable observation of unaffected downgradient areas.
- Design an oxidant injection program using existing wells, new injection wells, direct-push injection points, or a combination thereof. Appropriate spacing and alignment of injection points (i.e., grid formation) is important. To ensure uniform oxidant delivery throughout the contaminated zone, the zones of influence of all injection points should overlap. The amount of oxidant delivery should be determined by analyzing the amount of contaminant mass and soil oxidant demand.
- Design a groundwater monitoring network with wells in the vicinity of each injection point. Monitoring wells must be located near and downgradient of each injection point, so additional

temporary monitoring wells may need to be installed. The monitoring wells should be located at differing distances from the injection points so that dispersion of the oxidant can be tracked and adequate monitoring data can be collected. At a minimum the perimeter of the contaminant plume must be monitored to ensure no off-site migration of oxidant and/or contamination.

- Establish a field monitoring and sampling program that will adequately monitor both the dispersion of the oxidant and the effectiveness of the treatment in three dimensions. Usually measurements concerning oxidant dispersion are conducted more frequently than COC analysis.
- For gas injection systems, pilot testing should be performed to substantiate the gas-phase influence area around an injection point. This can be performed by evaluating pressure influence, DO increases, helium tracing, water table mounding, and concentration dispersion of the injected gas.
- For liquid-injection systems, the pilot test should substantiate the dispersion of the solution into groundwater (and should be performed separate from any gas-injection testing) to ensure that there is an appropriate influence area at varying injection flow rates. This can be performed by evaluating pressure influence, DO increases, water table mounding, or concentration of the injected fluid.

Both laboratory tests and pilot studies are valuable tools for determining the mass of oxidant necessary to adequately remediate a site. In most cases the oxidant demand of the soil matrix greatly exceeds the stoichiometric demand of the COCs present. Therefore, it is essential to include this variable in the design process.

### **5.3 Design of Oxidant Concentration and Volume**

The oxidant injection design concentration and volume is determined by considering several factors:

- the total oxidant dose required to degrade contaminants in the sorbed, dissolved, and nonaqueous (i.e., NAPL) phases, in excess of the losses caused by reactions with natural reductants and oxidant scavengers (i.e., organic carbon, reduced minerals, carbonates);
- oxidant reaction rates and subsurface persistence, which in some cases can limit the radius of oxidant delivery; and
- the desired radius of influence.

The injection volume is directly related to the fraction of the subsurface pore volume of the target area for treatment. Care must be taken to ensure that the contaminants are not displaced outside of the treatment zone by the injection.

The theoretical basis for determining the volume of oxidant necessary to achieve the desired hydraulic radius of influence is related to the pore space of the soil. The fluid injected into the subsurface will displace the fluid in the pore spaces. For the general case of injecting a liquid oxidant into the saturated zone of an isotropic, homogeneous aquifer, the volume of the aqueous oxidant injected displaces the same volume of water from the pore space. Porosity ( $\eta$ ) is the common measurement of the pore space of the soil:

$$\text{porosity } (\eta) = \text{volume of voids/total volume}$$

In an isotropic, homogeneous medium, this displacement takes the form of a cylinder, as shown in Figure 5-1. Knowing the desired radius and the height of this cylinder, one can determine the theoretical volume of soil that would be affected by the injection. Multiplying this total soil volume by the porosity determines the volume of void space from which the water is displaced. This volume can be considered a baseline against which the target injection volume can be compared. There is not a standard criterion for how many pore-volumes of oxidant solution must be injected to attain adequate treatment because it depends on the delivery method, oxidant dispersion/diffusion, and other site-specific factors.

The consideration of an idealized cylindrical injection volume is a highly simplified model of an injection. In reality, the subsurface environment is highly heterogeneous and usually anisotropic, and sometimes the secondary porosity (fractures, bedding planes, anthropogenic conduits, etc.) can represent most of the water movement in the subsurface. Also, many of the pores in the subsurface media are not interconnected, and water is not displaced from these dead-end pores. Diffusion is also taking place as the injected fluid displaces the water in the pore space. Many vendors take this into account by displacing only a percentage of the pore space in the desired ROI. Injection design must take all of these factors into account.

The concentration of the oxidant injected is related to the specific oxidant used, the oxidizable mass present, and the volume injected. The oxidant mass required is estimated based on laboratory testing and site contaminant delineation. This mass must be dissolved in the volume required for adequate distribution in the subsurface to determine the concentration of the injection fluid. Special considerations for each individual oxidant are discussed below.

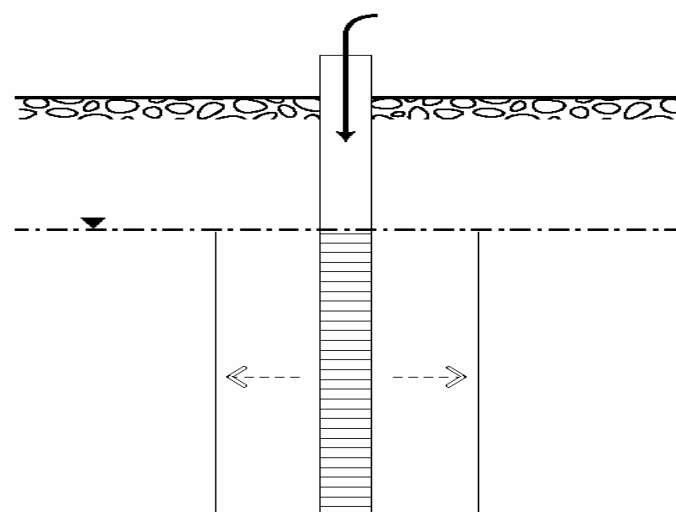
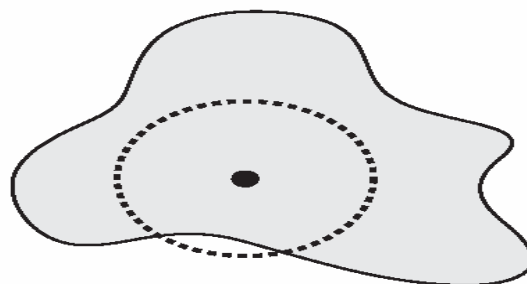

**Figure 5-1. Hydraulic radius of influence.**

### 5.3.1 Permanganate

Important environmental and design parameters can influence the ability to achieve effective oxidation using permanganate. As the dose concentration is increased, under otherwise comparable conditions, the rate of organic degradation increases, as would be expected. However, the amount of permanganate consumed also increases. The mechanism underlying this behavior may be associated with the decomposition of permanganate by the  $MnO_2$  solids produced by the oxidation reaction. NOM and reduced mineral species are also important to consider because it is usually necessary to add excess oxidant to overcome the oxidant demand of nontarget compounds. The kinetics of these nontarget reactions are considered fast, such that nontarget reductants can often compete with the target contaminants for the available oxidant.

Changes in conditions are important for evaluating system effectiveness as well as the long-term impacts of treatment at a site. Of note are changes in pH, Eh, ionic strength and composition, and the generation of  $MnO_2$  solids. These variables affect metal speciation and mobility and can also influence subsurface permeability/hydraulic conductivity. For example, at a site with limited buffering capacity, a decreased pH may result from treatment, causing the unintentional mobilization of many metals within the treatment zone because they are more soluble at a low pH. In some instances involving large masses of permanganate or where permanganate reactions are focused on a DNAPL interface, the production of  $MnO_2$  (s) may significantly lower the permeability of the soil matrix and/or may form a coating on DNAPL. However, as part of the Interagency DNAPL Consortium demonstration project at Cape Canaveral, 150,000 pounds of  $KMnO_4$  was injected into a 50- × 75- × 45-foot volume, and no reduction in soil permeability was discerned (Crimi and Siegrist 2003).

While the specifics of applications are very site dependent, ISCO systems have been engineered to include potassium and sodium permanganate solutions at concentrations ranging 1%–40% for treatment of contaminated groundwater using vertical and horizontal wells operated as either batch injection wells or as injection/recovery/recirculation well networks. For treatment of contaminated soil, potassium permanganate in concentrated solution or solid form (~50% by weight) has been delivered using injection lances, deep soil mixing, or hydraulic fracturing techniques. The choice between potassium and sodium permanganate is primarily based on economic considerations. While the unit cost of the solid material ( $KMnO_4$ ) is significantly lower than that of  $NaMnO_4$ , the use of large quantities of  $KMnO_4$  can require the use of sophisticated oxidant storage, transfer, and mixing equipment to produce a concentrated oxidant solution from the crystalline powder. In contrast, dilution of  $NaMnO_4$  to the desired injection concentration may be achieved using only a metering pump. Accordingly, the economic savings realized through the use of  $KMnO_4$  are offset by the higher associated handling cost, suggesting that the selection of either oxidant should be considered on a site-by-site basis using the design concentration, volume, and flow rate to guide the selection of preferred form of permanganate.

### 5.3.2 Sodium Persulfate

Sodium persulfate is the newest of the oxidants, and manufacturers and consultants have formed a joint development to develop the use of sodium persulfate for ISCO. Although there is limited peer-reviewed scientific literature for this process, some research has determined that chelated iron(III)

compounds can act as effective activators for the persulfate-based oxidation of VOCs. In many cases the activity of the chelated iron(III) activators is comparable to that of the iron(II) salts. Iron-EDTA will stay active in a soil environment, and it does not appear to come out of solution as do iron(II) salts. Thus, iron(III) EDTA will transport with the persulfate. The optimal catalyst loading for persulfate oxidation is 100–200 mg/L as Fe.

The research also determined that sodium carbonate can be added to persulfate mixtures to effectively buffer the pH. The carbonate does slow the reaction of persulfate some but does not inhibit the ultimate oxidation of VOCs. The optimal carbonate loading is approximately 20% of the persulfate loading on a mole basis. At this ratio, the pH stays above 4–5. Carbonate also appears to improve the stability of the persulfate. The concentration of persulfate appears to affect reactivity. Generally, the higher the persulfate concentration, the more rapid and effective it is in oxidizing VOCs. Persulfate does not appear to react readily with NOM.

### 5.3.3 Hydrogen Peroxide

Concentrations of peroxide injections typically vary 3%–35%  $H_2O_2$  (by weight), which can be applied at low or high pressures. Traditional approaches require a pH in the application wells to be 3.5–5 to maintain the solubility of the ferric iron activator. Many types of acid have been used to achieve this pH adjustment; however, the selection should be made to ensure that the acid is compatible with the geochemistry and contaminant so that adverse reactions do not occur. It should be noted that only the amount of acid necessary to initiate the reaction should be applied prior to peroxide application. Acid applied after the reaction has been initiated slows down or terminates the reaction. Typical acids include hydrochloric acid (HCl), sulfuric acid ( $H_2SO_4$ ), citric acid, and phosphoric acid ( $H_3PO_4$ ). Some modified approaches do not require pH adjustments. Instead the ferric iron solubility is maintained through the use of a chelating agent. This technique can be used at neutral pH conditions, which can be very beneficial in aquifers containing significant carbonate content where acid addition is impractical.

The 3% minimum  $H_2O_2$  concentration is generally used to initiate the reaction and in some cases is more applicable to injection without Fe to augment bioremediation of BTEX contaminants by adding additional oxygen to the subsurface. The 35% maximum is more typical of DNAPL recovery projects, where Fenton's reagent reaction heat and higher-pressure injection is solely intended to be used to mobilize residual DNAPL for capture in a nearby recovery wells.

The initial weight (or equivalent volume) of  $H_2O_2$  and Fe catalyst is based on contaminant levels in the saturated soil (sorbed or residual DNAPL) and aqueous phase, subsurface characteristics of the saturated soil and/or groundwater volume to be treated (i.e., hydraulic conductivity and effective porosity), as well as the specific stoichiometry of  $H_2O_2$ :Fe determined during a laboratory study. In all cases excess  $H_2O_2$ :Fe is applied to account for subsurface heterogeneity and related injection distribution inefficiencies, as well as uncertainties with site characterization in regards to presence, quantity, and location of DNAPL or sorbed contaminants.

#### 5.3.4 Ozone

Ozone concentrations are in the range of 5%–10% (by weight) when generated from oxygen and about 1% when generated from atmospheric air. Ozone generator capacities are typically expressed in terms of mass output (i.e., pounds ozone per day). Since the ozone generators produce a continuous ozone stream, the in situ oxidation process using ozone is a continuous process, compared to the batch injection approaches that are common with permanganate, persulfate, and Fenton's reagent. The ozone generator capacity required is determined from the overall oxidant loading required, the gas flow rates that the subsurface will accept, and the allowable time frame for treatment. For example, if 7,000 pounds of ozone is required to meet the matrix demand and the contaminant demand at the site and if one year is allowed for treatment, then the ozone generator capacity is determined from  $7,000 \text{ pounds} \div 365 \text{ days} = \sim 20 \text{ pounds ozone per day}$ . Since many ozone generators are very limited in flow rate capacity, it is important to select an ozone generator that will be capable of injecting the appropriate volume and flow rate of ozone. Some ozone generators inject less than 1 scfm, which may result in very limited (<5-foot) influence areas at each injection wells.

As with any ISCO process, it is important to have an estimate of the demand that a polluted aquifer will have on the oxidizer applied to properly design ozonation equipment and schedule remediation times. The total oxidant demand is defined as the total mass of oxidizer which brings a soil system to the point at which additional oxidizers can be added without any net reaction or loss of the dosed oxidizer within the soil matrix due to reactions with natural soil constituents. However, in many instances contaminant treatment may be obtainable at a lower oxidant dose. For ozone, this phenomenon relates to the fact that ozone degrades to oxygen and promotes aerobic biodegradation in combination with the ozone oxidation process. Ozone demand can be estimated for soil systems by tracking ozone reaction and transfer efficiency within small bench-scale reactors containing 30% (by weight) slurries of the actual site soils and water (using the site groundwater is best). By closing the mass balance of introduced ozone around the reactor, it is possible to calculate ozone demand using units such as milligrams of ozone per gram of dry site soil. Using aquifer porosity and soil specific gravity, ozone demand can be recalculated as pounds of ozone reacted over time per unit volume of aquifer.

#### **5.4 Design of Oxidant Delivery**

In general, oxidants are applied using a sufficient number of points/wells such that there is adequate overlap of horizontal and vertical "effective zones" where an oxidant is in contact with contaminants. In many cases, multiple application events or extended system operation are required when significant contaminant mass is present either sorbed to soil or as residual and free-phase DNAPL. Also, uncertainty in subsurface characterization data frequently leads to a phased approach, providing a more flexible strategy for treating the site contaminants. This allows for treatment of difficult contaminant hot spots without delivery of excess of oxidant to other areas of the site.

Oxidant transport can be reaction limited because the oxidants are being depleted as they move through the subsurface. Therefore, the effective radius of oxidation treatment may be substantially less than the hydraulic (or pneumatic in the case of ozone gas) ROI. Faster rates of oxidant reaction (i.e., shorter half-lives) lead to more limited transport distances. Modeling of the reactive transport



of oxidants is promising but not yet developed to the level where it is applicable to project designs on a routine basis. An extensive research program funded by the Strategic Environmental Research and Development Program is evaluating the rate and extent of oxidant demand reactions exerted by porous media for both permanganate and Fenton's reagent, with the objective of developing predictive models for oxidant transport.

The options for oxidant delivery are as varied as the range in techniques for drilling, well construction, and solution injection. Former monitoring, SVE, pump-and-treat, and temporary direct-push wells can be used for either injection or monitoring purposes. However, it is ideal if monitoring wells are not used for injection purposes to ensure they are monitoring general subsurface conditions and are not directly affected by the injection. Caution should be used when using existing monitoring wells that are screened above the water table since the injected oxidant (even if injected with a packer in the well) will likely be directed up the well-packing material (between the well and the boring) where a packer does not exist. In many cases, using specifically designed injection points or equipment may be more appropriate. Depending on the oxidant and oxidant concentration that is injected (for example, for high-concentration ozone delivery), stainless steel injection points may be needed. Injections can also be completed through direct-push batch injections. For oxidants which have a longer in situ half-life, such as permanganate and persulfate, oxidant delivery may also be approached using groundwater recirculation. With this option an oxidant solution can be injected in and upgradient of the target zone and then extracted downgradient of that target zone and reamended with additional oxidant prior to reinjection. The advantage of this approach over batch addition for the more stable oxidants is that it provides hydraulic control in the treatment zone and ensures that any excess oxidant traveling downgradient of the treatment zone is captured and reinjected. However, the recirculation approach requires more complicated and costly aboveground infrastructure, making it cost-effective for only highly contaminated sites.

The oxidant injection pressure and flow conditions are also important and relate closely to oxidant transport. Injection at low to moderate flow rates under Darcian-flow (i.e., laminar) conditions usually involves gravity feed into an injection point. On the other hand, if an oxidant is injected under substantial pressure or velocity, the turbulent flow can result in hydraulic fracturing or soil jetting. Pressurized injection may be advantageous because it can result in less plug-flow displacement and faster lateral transport. However, if the soil fracture pressures are exceeded, then caution is needed to ensure that the fracture geometry is controlled so that the fractures do not move upward to a nontarget zone or potentially breach to the ground surface. In cases where the oxidant is being applied for DNAPL treatment, the mobility of the DNAPL from the pressurized injection must also be considered prior to application.

There are numerous techniques for using direct-push technologies with many vendors developing customized direct-push tools or injection well designs to get better vertical and horizontal distribution of reagents. Injection wells are used when multiple injection events are planned, when the depth to contamination is beyond the capabilities of direct-push injection, and in bedrock. Injection wells may need to be built to additional specifications to be able to hold pressures generated from subsurface reactions. Usually this process involves the use of bentonite chips versus grout to seal the well bore. Additionally, when injections are under buildings or streets, horizontal wells may be used. During these cases it is important to ensure equal distribution of reagent along the entire horizontal well length. During injection well construction, implementation of a quality

assurance/quality control plan is critical to ensuring injection wells are constructed per specifications. Additionally, injection wells are usually screened from 10- to 20-foot intervals to ensure uniform distribution of reagents.

Direct-push injection is often used where the depth to contamination is <100 feet and there are no geologic barriers that result in refusal. The advantages of direct-push injection are that it is easy to move the injection locations during additional treatment events to target specific hot spots. Additionally, injection tools can target 1-foot intervals, ensuring uniform vertical distribution of reagents in the treatment zone. Where injections are required in public streets or through building floors, direct-push injection can result in less disturbance in daily operations. Vendors have developed customized injection tooling to provide more effective distribution of reagents than by just injecting from the end of the direct-push rod. It is important to understand material compatibility with the various oxidants when designing injection systems.

#### 5.4.1 Radius of Influence—Liquid Injections

Typical ROIs for injections range from 2.5 feet for tight clays to 25 feet in permeable saturated soils. In addition to lithology, the ROI varies based on the oxidant properties, the injection technique, and pressure. The reaction rates of the oxidant injected can limit the distance it can travel in the subsurface. Faster-reacting oxidants, those that use the radical reaction pathway, will react before they have time to travel appreciably. Therefore the hydraulic ROI will overestimate the actual oxidant dispersion for faster-reacting oxidants. Subsurface environments are rarely homogeneous and isotropic, and the injection design must also take this fact into account. For example, Figure 5-2 illustrates a system in which there are two layers of differing permeabilities in the injection zone. The upper zone has a relatively low permeability (e.g., silty clay), and the lower zone has high permeability (e.g., sand). Because the oxidant can enter the sand zone easier than the silty clay zone, the ROI will be greater in the sand. If oxidant distribution in the silty clay is desired, the injection zone must not intersect the sand.

Figure 5-3 illustrates another example of how the injection design can affect ROI. Many ISCO injections are completed with a geoprobe and use a bottom-to-top injection scheme. In this type of application the geoprobe rod is pushed to the desired depth, and the oxidant is injected in intervals from the bottom upwards. As the rods are raised toward the surface, the thickness of the injection zone increases, so the volume of oxidant required to achieve the desired ROI increases. If this fact is not taken into account and equal volumes are injected in each interval, the volume of the subsurface media treated resembles an inverted cone rather than a cylinder. The variation in ROI is an important reason to perform effective pilot testing. Effective pilot-test data enable a design engineer to ensure that the injection system is appropriately designed.

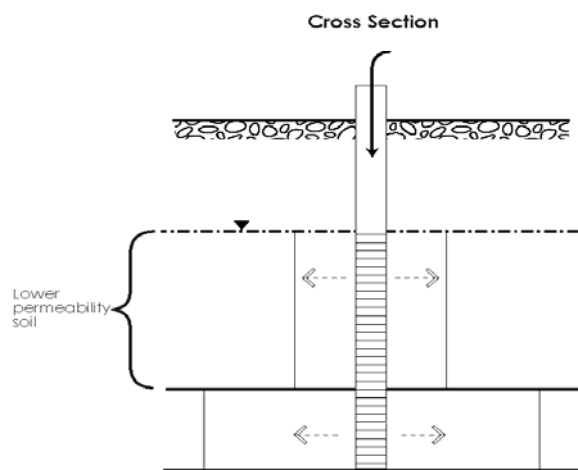
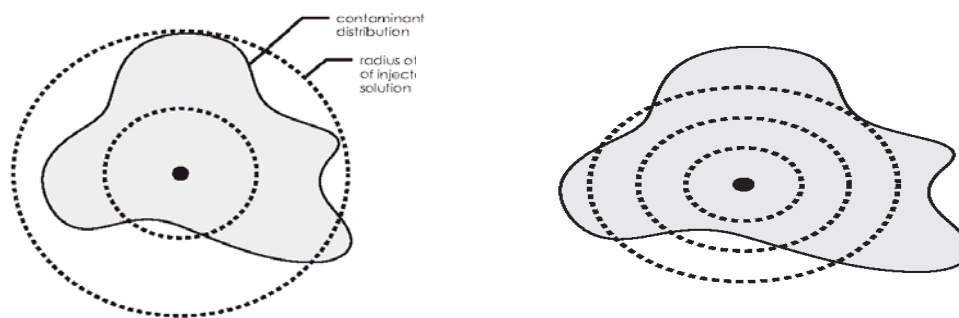

**Figure 5-2. Permeability influences.**

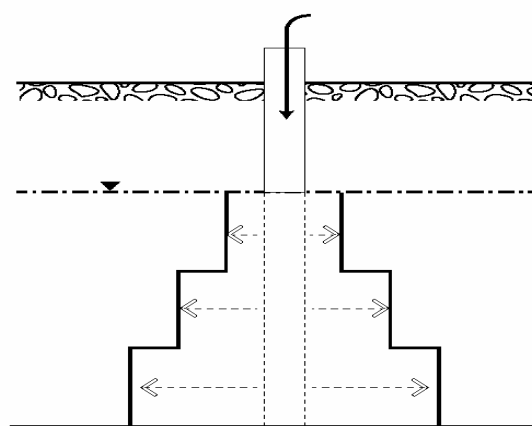

**Figure 5-3. Bottom-up injections.**

#### 5.4.2 Radius of Influence—Gas Injection

For gas injection systems, feasibility tests should be performed to substantiate the design flow rate and pressure at various injection wells. The delivered gas during feasibility testing is typically ozone or air. Air can be used instead of ozone to determine flow/pressure versus influence area data (ozone distribution in the subsurface acts similarly to air injection at similar injection flow rates and pressures). Air may even be used during the actual oxidation event to help distribute the oxidizing species or to increase ozone flow rates.

Feasibility testing should be performed similar to air sparging tests, where the gas being injected is delivered into a screened point installed within saturated soils at varying injection pressures and flow rates. During each injection step, the pressure and flow rate should be increased so that influence area data can be collected. Influence data that should be collected includes, monitoring for water table mounding due to groundwater displacement, observing pressure influences at surrounding observation wells (gas injection will typically result in pressure changes in the vadose zone within the areas of influence), DO changes at surrounding observation wells, or increased head space and/or dissolved concentration of the injected gas (performed when injecting ozone). It is also possible to

inject a tracer gas (such as helium) with the injection gas that can be more easily detected at observation wells.

One of the most common limitations with ozone injection systems is the design flow rate of the ozone system. Many small ozone generators cannot provide an effective influence area due to the limited flow rate capacity of the generator. These problems typically occur when pilot testing is not performed and ozone equipment is selected without a design basis. Pilot testing should always be conducted prior to the system design to understand the appropriate flow rate needed at each injection point to achieve an effective influence area and to appropriately identify the well spacing.

### 5.4.3 Soil Fracturing

Fracturing technologies, originally developed in the oil and gas production industry, have been used for environmental applications to enhance a wide variety of remediation technologies, including pump and treat, bioremediation, air sparging, SVE, and ISCO. Fracturing is used primarily in low-permeability soils (e.g., clays) and bedrock to enhance the permeability or hydraulic conductivity of the formation. Increases in hydraulic conductivity (K) ranging 1.5–175 times the prefractured K values have been reported. The increase in hydraulic conductivity is usually accompanied by an increase in the effective ROI of the treatment wells, thus requiring fewer wells to treat a given area. Additionally, the network of established fractures may shorten diffusive pathways and provide access to “pockets” of contamination that cannot be otherwise accessed.

In ISCO applications, fracturing has generally been conducted prior to oxidant injection to create distinct fractures, which increase both the ROIs and the potential injection rates for oxidant injection. However, oxidants may also be delivered as a supplement during the fracturing process. Fracturing technologies can generally be divided into two categories, hydraulic and pneumatic fracturing.

Hydraulic fracturing is used in low-permeability and overconsolidated clays to create sand-filled fractures. A slurry consisting of water, sand and a thick gel is injected into the subsurface under high pressure to create radial fractures. The residual gel biodegrades, leaving a sand-filled fracture. Fracture radii of up to 60 feet and up to 1–2 cm in thickness have successfully been developed. Fracture radii generally increase with depth. Injection flow rates on the order of 20–30 gpm and pressures on the order of 1.5–2 psi per foot of depth are common.

Pneumatic fracturing is used in bedrock and well-indurated sediments. Air is injected in short bursts under high pressure to create a radial fracture zone. Pneumatic fracturing differs from hydraulic fracturing in that no proppant (e.g., sand) is injected to maintain the fracture aperture after the fracturing is complete. Thus, the aquifer material must be sufficiently strong so that the fractures stay open. Swelling clays and other low-strength materials are not appropriate for pneumatic fracturing. Fracture radii of up to 70 feet have been reported. Fracture thicknesses, after settling, are much smaller than propped hydraulic fractures and generally range on the order of 0.5–1.0 mm. Air injection flow rates on the order of 700–1,000 cfm and injection pressures in the range of 70–150 psi are common. Pneumatic fracturing is a proprietary technology offered by a single vendor.

Both hydraulic fracturing and pneumatic fracturing are commonly conducted from a cased borehole, which is sealed above and below the desired fracture zone by packers, surface casing, or other means. The fluid is injected under pressures high enough to dilate the borehole wall and open adjacent cracks. Once the pressure exceeds a critical value, a fracture begins to propagate and continues to grow until the fracture intersects the surface (“daylights”) or a subsurface barrier, the pressure dissipates through the fracture trace walls, or the injection is ceased. The resulting fractures are usually horizontal or somewhat vertically inclined. The inclination of the fractures is a function of the injection pressure, the lithology of the formation (e.g., strong bedding planes, wetting/drying history, etc.), the depth of the fracture, and the overconsolidation ratio of the soil. Fractures may remain open naturally or may be held open by a proppant, such as sand.

Under the best of circumstances, it is still difficult to predict the fracture pattern, radius of fracturing, or inclination of fractures using available models. For this reason, fracturing near structures, utilities, or other sensitive areas should be approached with extreme caution. In addition to the high pressures experienced in the subsurface during fracturing, surface deflections (e.g., a rise in the ground surface) are usually experienced during fracturing. These surface deflections normally recede to an extent over time, but some permanent deflection (on the order of 1–2 cm) should be expected, particularly for hydraulic fracturing applications where a proppant is added.

In fact, measurement of surface deflections at multiple locations during and after the fracturing is one of the methods utilized to estimate the formation and pattern of subsurface fractures. Electrical resistivity equipment such as tiltmeters are also commonly employed to measure ground surface slopes created during fracturing. Injection of graphite or other conductive material into the fractures to allow tracing of the fractures using conductance measurements has also been reported.

#### 5.4.4 Permanganate Delivery

There are two main approaches for delivering permanganate solutions into the subsurface, batch addition and recirculation (Figure 5-4). Permanganate has also been incorporated into a solid slurry for remediation of low-permeability clay units using hydraulic fracturing. Permanganate is more persistent in the subsurface than  $H_2O_2$  or ozone, so the ultimate ROI in highly permeable saturated soils can be >100 feet. This fact should be taken into account when designing injection volumes.

A recirculation approach is commonly selected for this oxidant in cases where the area or quantity of contamination is very large. Again, the type and location of injection and extraction wells varies widely and selection must be site specific. As part of the infrastructure design, some consideration should be made for the potential for any extracted contaminants to react with the permanganate above ground, which can produce manganese dioxide precipitates. This effect can be achieved through removal of the contaminants prior to oxidant addition (i.e., air sparging in a storage tank, air stripping) or removal of solids after oxidant addition (i.e., using a settling tank or in-line filters).

In some projects permanganate has also been injected in a solid crystallized form as a reactive barrier. In these cases the solid permanganate has been mixed into contaminated soil using large augers. This approach is most applicable to shallow contamination within the vadose zone. Soil mixing is illustrated in Figure 5-5.

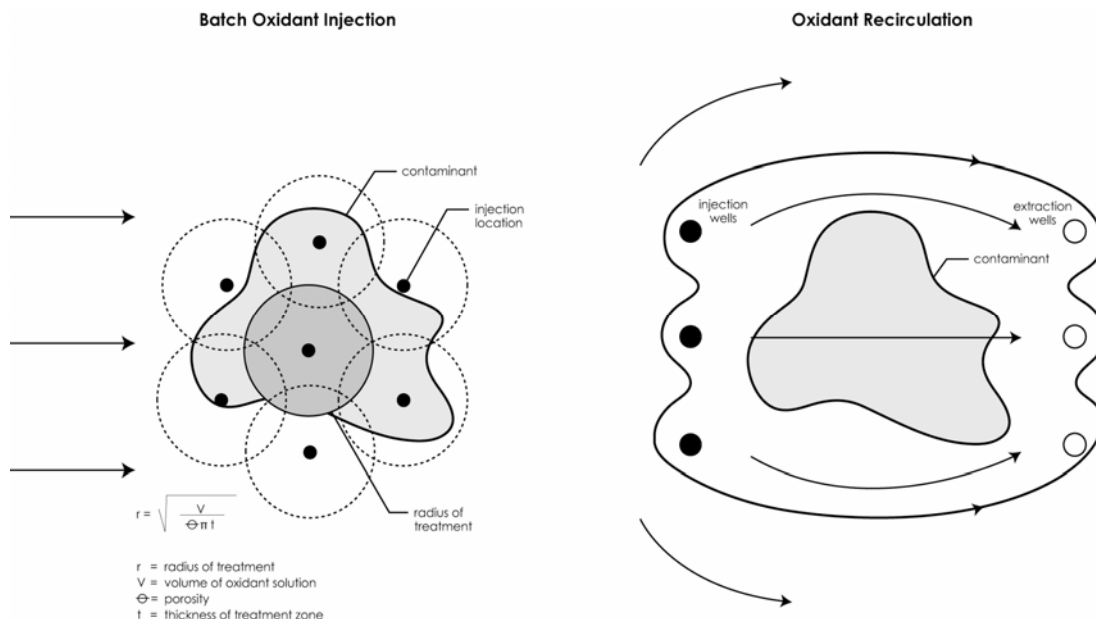

**Figure 5-4. Batch versus recirculation.**

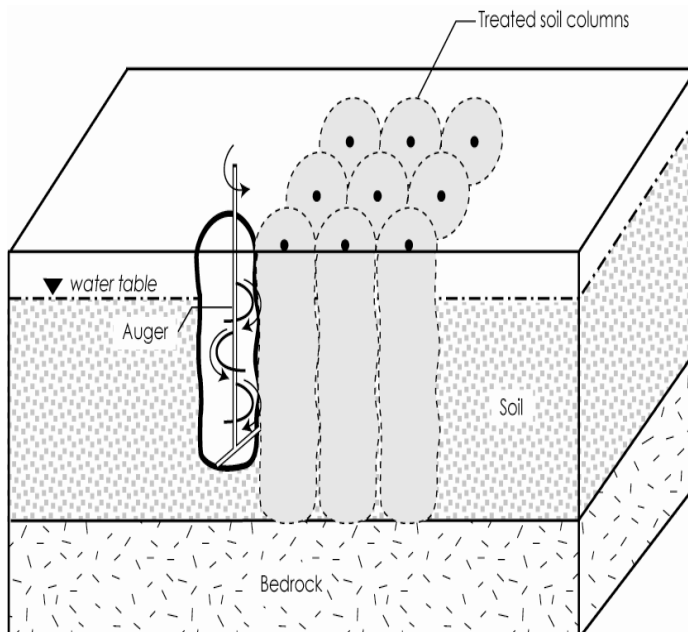

**Figure 5-5. Soil mixing.**

#### 5.4.5 Persulfate Delivery

There are two main approaches for delivery of persulfate solutions into the subsurface, batch addition and recirculation. Persulfate is more persistent in the subsurface than H<sub>2</sub>O<sub>2</sub>, or ozone, so the ultimate RIO in highly permeable saturated soils will be greater. This fact should be taken into account when designing injection volumes. As with permanganate, well pressurization doesn't occur

for persulfate as there is also a limited release of gases in delivery wells. A recirculation approach can be selected for this oxidant in cases where the area or quantity of contamination is very large. Again, the type and location of injection and extraction wells can vary widely and selection must be site specific.

#### 5.4.6 Fenton's Reagent Delivery

There are several approaches for applying Fenton's reagent. The most common are as follows:

- A sequential injection of  $H_2O_2$  and Fe ensures distribution of reagents before reacting. There appears to be no benefit of applying either reagent first.
- $H_2O_2$  and Fe can be injected concurrently and mix at the end of well bore; thus they are distributed while reacting.

If injection wells are used with pH adjustment, stainless steel wells are required to accommodate the acid injection. Reagents can be injected at either low (<25 psi) or high pressure. High pressure is typically used to mobilize DNAPL and LNAPL prior to recovery or for achieving better distribution in a less permeable zone.

It should be noted that, because iron initiates a potentially vigorous reaction, the mixing of iron and peroxide not be performed in tanks prior to injection. In certain instances when ferrous Fe is available in situ, the design can even forgo the application of the Fe catalyst. The heat generated from the reaction can also be used to encourage contaminant volatilization and thermal oxidation. At a number of sites, a top-down injection approach has been implemented with Fenton's reagent when significant contamination exists just below the surface. By delivering the reagents into the groundwater at a shallow depth, a "blanket" can be created to consume organics as they rise due to volatilization from the heat generated by the exothermic reaction.

One advantage of applying  $H_2O_2$  at lower concentrations is that the most efficient generation of the superoxides and hydroxyl radicals occur at low temperature (<160°F) and at low pressures (<0.42 psi/foot of soil). Besides the obvious safety benefits of working with a lower concentration of  $H_2O_2$ , low concentration applications reduce the chance of excessive heat and gas generation (e.g., short-circuiting) and reduce the potential of simply stripping contaminants from aqueous phase to the vapor phase without oxidizing them (Frisbie 1992). In these cases, a vapor recovery system is required. Additionally lower concentrations and no acid injection are more amenable to ongoing natural attenuation once treatment has been completed. Most shipments of  $H_2O_2$ , either in drums or bulk, are 35% or 50%  $H_2O_2$ . Vendors have demonstrated the ability to safely blend and inject at lower concentrations using water as the diluting fluid.

In most peroxide applications, bench- and pilot-scale testing are performed to ensure the successful full-scale implementation. Bench-scale testing is used to quantify treatment efficiencies of contaminants in saturated soil and the dissolved phase. In addition, the bench test identifies any adverse reactions or precipitates that could affect the efficiency of the reaction in the soil or groundwater. Pilot-scale testing is performed to confirm injection parameters, such as reaction rates, temperature, pressures, ROI, and injection volumes and rates.

In areas with water tables close to the surface, exothermic reactions must be controlled to a greater extent because the heat generated causes the expansion of the water and may result in aboveground flooding. Heat generation should be minimized in these cases to avoid this outcome.

#### 5.4.7 Ozone Delivery

The most common type of ozone generator on the market is the corona discharge generator, used almost exclusively with ISCO applications. This generator produces ozone by passing dry air or oxygen between two concentric, annular metallic tube electrodes of opposite charge, resulting in the production of ozone in 2%–5% and 4%–10% (by weight) ranges, respectively. Key considerations for ISCO applications are the need for dry air, oxygen concentrators, or oxygen sources on site; the requirement of cooling water for the generator; and a generator compressor having higher pressure capacities than typically used with ozone generators within water treatment systems.

The requirement of an ozone generator can dramatically increase capital costs. However, the reduced cost of continuously supplying ozone via the generator over the length of the remediation project as compared to always paying for delivered oxidants coupled with potentially shorter remediation times may easily offset this higher up-front cost. Additionally, ozone generator costs can be reduced if multiple sparge points are serviced by one generator. Ozone is corrosive with many materials, so special considerations are required for the selection of process equipment that will contact ozonated media. Stainless steel, Teflon, and Kynar are excellent materials for this purpose.

Since ozone is contained within a gas stream (<10% levels of ozone within air or oxygen), mass transfer of the ozone from the gas phase into the water phase is required. The most common ways of accomplishing ozone introduction are sparging into the aquifer, using designs similar to those successfully used with in situ air sparging for stimulated aerobic biotreatment, or injection of ozonated water into the aquifer via tank sparging or the use of a venturi in-line gas injector. Of the two introduction options, in situ sparging is the better and more commonly used option because of the high oxidizer demands associated with most aquifer systems. For perozone oxidation, ozone is introduced the same way as with ozonation, while hydrogen peroxide is introduced using the well-established techniques used with Fenton's reagent applications.

Diluted air streams are sometimes blended with ozonated gases prior to injection into sparge points. Potential sparge points are usually vertical or horizontal wells screened within the saturated zone. Often numerous wells are sparged as "clusters" using a cycling sparge schedule (for perozone, hydrogen peroxide dosing must be conducted immediately prior to ozonation for the sparge points). Depending on the volatility of the pollutants, sparge rates can range from 1/4–2 scfm for most applications, but if contaminant volatility is not an issue, even higher rates of gas addition are possible depending on site conditions (for this case, following high-rate aquifer air sparging designs). One interesting aspect concerning volatile pollutants is the very rapid degradation rates observed for both benzene and TCE within air phase reactions reported. These data offer some evidence that reactions of ozone with volatile pollutants within the gas phase occur even to the point where no pollutants or ozone may escape from the ground surface.



## 6. MONITORING REQUIREMENTS

There are two types of monitoring conducted at remedial sites, process and performance monitoring and post-treatment and closure monitoring. Process and performance monitoring is completed during the most active phase of remediation on a frequent basis to ensure adequate distribution of the oxidant and monitor migration of both solubilized metals and contamination. Post-treatment and closure monitoring is conducted on a less frequent basis after the subsurface reaches equilibrium mainly to verify contaminant destruction.

### 6.1 Process and Performance Monitoring

From the regulatory perspective, one of the most important topical areas within ISCO remediation is process and performance monitoring. Process and performance monitoring is important to all stakeholders in ISCO remediation projects because it addresses the following basic concerns regarding the selected technology:

- applicability,
- effectiveness,
- safety,
- time to completion,
- rebound potential, and
- final cost.

As a remediation plan is implemented, the process should be monitored to continually confirm that the technology is operating as designed. One of the most challenging aspects of conducting remediation is determining whether the action was a success or failure. This determination can be made in a defensible way only through an adequately designed performance monitoring and assessment process that demonstrates achievement of treatment objectives, e.g., reduction in mass flux resulting in shutdown of pump-and-treat systems. Performance monitoring and assessment must provide information compatible with the agreed-upon regulatory framework treatment objectives.

Process monitoring is done as a quality control measure before, during, and immediately after the injection operation. Common objectives of process monitoring include the confirmation of oxidant injection concentrations, volumes, flow rates, and the ROI of the injection. For some oxidants it also includes the measurement of oxidant impact on groundwater temperature and pressure within the injection well. Process monitoring is also an important component of a comprehensive health and safety program. Performance monitoring includes establishing baseline conditions at the site prior to remediation, determining the measurement of contaminant reduction, and monitoring contaminant release and/or migration. Process and performance monitoring is usually completed on a more frequent schedule than post-treatment and closure monitoring.

Establishing baseline conditions includes the analysis of soil and groundwater samples from the site for target contaminant(s); potential biological or abiotic degradation by-products; metals; and parameters such as pH, ORP, and DO. For example, ISCO has a potential to generate by-products. After the oxidant application, it is easier to identify the by-product(s) as a reaction by-product or rule it out as a preexisting or baseline condition. For a site remediation situation that includes oxidant

application under an occupied building, it is beneficial to screen the indoor air for VOCs prior to oxidant application. Then it would be relatively easy to determine whether media transfer is taking place due to off-gassing of contaminants. Additionally, establishing a baseline condition helps gauge the progress of the reactions and determine when the oxidation-reduction reactions are complete. Ideally, monitoring point(s) should be located upgradient of a contaminated zone of a site for establishing the baseline conditions.

An issue that must be resolved when assessing treatment effectiveness is the role of displacement of contaminated water away from the injection points. Depending on sampling locations observed, post-injection declines might reflect the displacement of contaminated water rather than actual contaminant mass destruction. The before-and-after monitoring results at the site should indicate whether or not displacement occurred. The results of monitoring at all locations in the plume should show a decline after the injections if displacement is minimized. If contaminated water had been displaced from the source zone into the plume, increases in contamination at one or more plume locations would be expected. Another concern inherent in remediation performance assessment is the potential for rebound of contaminant concentrations in the treated zone as a result of persistent residual DNAPL dissolution. Comprehensive post-injection sampling should be completed at least three months after the last injection. Rebound will be high if appreciable DNAPL mass remains in the source zone and soil/groundwater equilibrium should be reached within this timeframe.

For both saturated and unsaturated zone contamination, analysis for organic contaminants in both soil and groundwater is critical for in situ oxidation. Analysis of groundwater alone does not enable determination of the mass of contaminant desorbed from saturated soil. Groundwater analytical data obtained during the in situ oxidation process frequently shows transient increases and decreases in contaminant levels because of the desorption of contaminants in soil. A common observation is that dissolved organic contaminant levels increase after injection events, followed by a permanent decrease as the contaminant mass is degraded and the aqueous phase reequilibrates with the saturated soil. This observation reinforces the importance of a comprehensive saturated soil investigation and adequate monitoring well network. For sites where only the unsaturated zone is contaminated, analysis for organic contaminants in groundwater is necessary to monitor the leaching of organics from the unsaturated zone. The spatial location of the monitoring points should be carefully selected so that they are located downgradient of the contamination, and the screened interval of these points should be at the proper depth. For example, a sample from a well screened from 25–30 feet bgs may miss the migration of contaminants in the formation if the source of contamination is only 5 feet bgs. A good conceptual site model including subsurface lithology and contaminant mass/location is essential in the creation of an adequate monitoring network.

To accurately represent the performance of a remediation technology, it is important to modify the sampling and analysis protocol for the target contaminant and/or potential by-products. Unless sampling and analysis is conducted in situ by portable instrumentation, it is critical to remove oxidant(s) from the sampling vial prior to sending out samples for analysis at a laboratory. Current EPA methods for analysis of VOCs allow for a 14-day holding time prior to analysis; therefore, contaminant concentrations in a media at the time of analysis will be lower than on the date of sampling when an oxidant is present in the sampling vial.

Generally, injection points are not suited for either performance monitoring or post-closure monitoring to provide accurate insight of the success of a cleanup. Concentrations of target contaminants in an injection well are expected to be lower than in the formation because of the presence of higher concentration of oxidant, and therefore such measurements are not representative of site conditions. However, if sufficient time is allowed for the hydrogeologic conditions to equilibrate after an oxidant is used up, monitoring at the injection points may be useful. Temporary direct-push wells may be an inexpensive way to augment an existing monitoring well network.

Where DNAPL is involved, it is important to reach consensus among stakeholders on how saturated soil and dissolved-phase concentrations will be used to determine the reduction of residual and free-phase DNAPL. In some instances a mass flux monitoring approach may be used to demonstrate the reduced flux of contaminants from the DNAPL leaving the site and impacting sensitive receptors (ITRC 2000). Given the difficulties in collecting reproducible soil samples at sites where DNAPL may be present and the reliance of regulatory agencies on groundwater criteria for determining site closure requirements, groundwater monitoring is a critical component of process monitoring of an ISCO system during treatment system operation. In particular, monitoring the concentration of chloride, a typical product of chlorinated solvent oxidation, can provide evidence of ongoing treatment by the injected oxidant. Contaminant concentrations in groundwater should be measured on a frequent basis initially to ensure released contaminants do not migrate away from the site. For sites with LNAPL or DNAPL under an occupied building, ISCO should not be used unless a design for adequate collection of gases is in place.

Analysis of dissolved metals in groundwater is also important, since certain redox-sensitive metals can be oxidized to a more soluble state, especially with a more persistent oxidant like permanganate. The primary metals of concern include arsenic, barium, cadmium, chromium, copper, iron, lead, and selenium. All of these metals are more mobile in an oxidized state. They may currently be in a chemically reduced, insoluble state at a particular site and therefore not detected in groundwater. However, because they are more soluble under oxidizing conditions, these metals can be mobilized by in situ oxidation. Sites where this effect could be a potential problem can include sites where either naturally occurring metals concentrations in soils are elevated or historical metals contamination was attenuated by naturally occurring chemical reduction processes. Metals released by historic processes may be bound up with organic substances (such as humic acids) and may be released when these substances are oxidized by the oxidant. In most cases, field and laboratory data have shown that the metals liberated by oxidation are readily attenuated back to background conditions. However, this may not always be the case.

To minimize the possible risk of mobilizing metals at a site where ISCO is implemented, several steps can be implemented for site screening:

- Soil laboratory data of total metals content can indicate whether the site contains sufficient metals to be problematic.
- More detailed evaluation can be performed by conducting laboratory treatability tests using samples of soil and groundwater from the site. In these bench-scale tests, aquifer materials are subjected to oxidation, and the solution water is analyzed for metals content before and after treatment. If metals are liberated into the aqueous solution, this solution can then be exposed to

site soils to determine the ability of the soils to attenuate the metals to background or baseline conditions. At the field scale, metals analysis of groundwater samples is important to verify that metals mobilization is not occurring.

Common field monitoring parameters and suggested analyte techniques are summarized below:

- contaminants, EPA SW 846 8260B;
- oxidant, field test kit;
- metals, EPA Method 200.7 (ICP), SM 3120B;
- major ions (Na, K, Ca, Mg, Fe), EPA Method 200.7 (ICP) SM 3120B;
- nitrate, sulfate, and chloride, EPA Method 300—ion chromatography;
- alkalinity, as CaCO<sub>3</sub>, EPA Method 310.1, SM 2320B;
- ORP (Eh) field measurement, SM 18 ED 2580B;
- pH, hydrogen ion field measurement EPA Method 150.1, 18 ED;
- temperature, field measurement EPA Method 170.1, 18 ED; and
- specific conductance, field measurement EPA Method 120.1, 18 ED.

In sensitive settings such as a site overlain by occupied buildings, monitoring of key parameters—including VOCs, temperature, LEL, etc.—should be initiated. This monitoring is particularly important for application of Fenton’s reagent injected at high concentrations and at high pressure. For ozone, continuous monitoring of ozone gas, VOCs, and oxygen should be conducted.

#### 6.1.1 Permanganate

To confirm ROI, permanganate can be detected in monitoring wells by the purple color and measured with a field spectrophotometer. Since the kinetics of permanganate oxidative reactions are second order, they are concentration dependent. Thus, the sufficient concentration of the permanganate is necessary for the degradative reaction to proceed. The rule of thumb is that all monitoring wells in the treatment zone should have >50 ppm, which would be dark purple in color. It is important to measure metals and contamination in downgradient monitoring wells frequently to ensure that these constituents are not mobilizing and/or migrating. This phenomenon usually occurs in the initial stages, so monthly sampling for the first three months is recommended.

#### 6.1.2 Sodium Persulfate

To confirm ROI, iron, pH, or persulfate can be measured in monitoring wells. It is also important to measure metals and contamination in downgradient monitoring wells frequently to ensure that these constituents are not mobilizing and/or migrating. This phenomenon usually occurs in the initial stages of implementation, so monthly sampling for the first three months is recommended.

#### 6.1.3 Hydrogen Peroxide

During applications, several key parameters in the application wells should be measured to ensure that the design application is maintained and that a safe application can be assured. Table 6-1 outlines the injection well process monitoring parameters.

**Table 6-1. Injection well process parameters**

<b>Parameter</b>	<b>Method</b>	<b>Frequency</b>
PH	Field screening tool	Beginning and daily
Temperature	Thermocouples	Constant
Pressure	Application well gauge	Constant

Each of these parameters should be within the specific design range to ensure the optimum efficiency of the process and that the reaction will remain within safe parameters to avoid excessive off-gassing, contaminant migration, or overconsolidation of the soil. In addition to the application of well process monitoring, it is beneficial to observe process parameters at the adjacent monitoring wells to determine the rate at which the process reaches it, the optimum treatment radius or the process ROI. Table 6-2 outlines useful field parameters and the measurement frequency for Fenton's applications.

It should be noted that the sustained design ROI is not reached instantaneously but in many cases may take several days to achieve and stabilize. This fact is important when performing a pilot application to ensure that the optimum ROI is achieved and maintained. In sensitive settings such as a site overlain by occupied buildings or subsurface structures, monitoring of key parameters, including VOCs and temperature, should be initiated. This monitoring is particularly important for application of Fenton's reagent injected at high concentrations and at high pressure.

**Table 6-2. Monitoring well process parameters**

<b>Parameter</b>	<b>Method</b>	<b>Frequency</b>
pH	Field screening tool	Beginning and daily
Temperature	Thermocouples	Constant
ORP	Application well gauge	Daily start and close
DO	Downhole field tool	Daily start and close
Conductivity	Downhole field tool	Daily start and close
Iron	Field screening tool	Daily start and close
VOCs	Field screening tool	Daily start and close
CO <sub>2</sub>	Downhole field tool	Daily start and close

Since reduction of contaminant mass in the saturated soil is a key component of successful groundwater remediation, baseline and post-treatment saturated soil samples are critical in assessing performance. Section 2 presents guidance for evaluating total mass. It is also important that all stakeholders are in agreement as to the methodology used to select sample locations, collect samples, and interpret results.

#### 6.1.4 Ozone

Continuous monitoring of ozone gas, and VOCs, should be conducted. Since ozone is a strong oxidant gas, safety procedures must be followed when performing in situ or process monitoring to avoid contact with ozone gas, which may be present in site monitoring wells or system piping.

## **6.2 Post-Treatment and Closure Monitoring**

One of the most challenging aspects of conducting a remediation is determining whether the remedial action was a success or failure. This determination can be made in a defensible way only through an adequately designed post-treatment and closure monitoring and assessment process that demonstrates achievement of treatment objectives, e.g., reduction in mass flux resulting in shutdown of pump-and-treat systems. Post-treatment and closure monitoring and assessment must provide information compatible with the agreed-upon regulatory framework treatment objectives.

Subsurface conditions after oxidant injection should be allowed to reequilibrate prior to post-treatment and closure monitoring. Monitoring for temperature, presence of residual oxidant, LEL (for indoor air and utility areas), etc. can help determine whether chemical reactions are completed. To determine the effectiveness of treatment and to evaluate whether the desired degree of oxidation and desorption was achieved in both saturated soils and the aqueous-phase contaminant, monitoring should continue quarterly for at least one year following the completion of treatment and oxidant activity to ensure no rebound occurs. During this post-treatment monitoring phase, it is expected that the site should have come back into equilibrium and concentrations can be expected to approach treatment goals. Should concentrations increase over two consecutive quarters, it is most likely that rebound is occurring and that there is still untreated contaminant mass in the saturated soils causing increasing dissolved-phase concentrations. A subsequent injection may be necessary.

States differ on the amount of monitoring necessary to achieve site closure. Most states like to see data collected long after the injection takes place to ensure the new equilibrium has been achieved. It is not uncommon for states to require annual monitoring for three years to conclude that the contamination will remain below the target levels in the long term.

## **7. TRIBAL AND STAKEHOLDER CONCERNS**

Stakeholders and representatives of any affected tribes should be involved at every stage of the evaluation, selection, and permitting of treatment systems and in the selection and performance evaluation of vendors. Such involvement leads to better, more defensible solutions and expedites cleanup of contaminated sites. One of the objectives of the responsible parties must be to integrate tribes and stakeholders into all of their processes.

Since chemical oxidation methods are a relatively new technology, when such technology is being considered for permitting or deployment for the first time in a given area, stakeholders and tribal representatives should be given the opportunity to comment and to make their issues, needs, and concerns known. Information about the technology, including alternatives analysis, should be made widely available for public comment.

Chemical oxidation methods may have the potential benefit of cleaning up a contamination problem quickly and therefore may be regarded favorably by tribes and stakeholders. However, since chemical oxidation methods involve the introduction of a chemical reagent into the environment, tribes and stakeholders will have the obvious question: Will it do any harm? This question must be addressed carefully and honestly.

In some instances, one can cite the examples where the technology has been tried before and report on its success or failure in each situation. In the case of an immature technology, one may be in a situation where one is proposing a solution that is believed to be likely to work but has not been tried previously in a parallel situation. Explain all of the reasons why you believe that the technology is likely to work. Give the details of what you believe to be the possible failure scenarios. How likely is the technology to fail? What damage might be done? Have public discussions about the alternatives. It is possible that tribes and stakeholders will embrace an opportunity to try a new solution to a contamination problem, particularly if there is a good chance that it may succeed where other solutions are likely to fail. Be open to the potential risks and benefits. Affected tribes and stakeholders must be given the opportunity to weigh the potential risks against the potential benefits since they are often the ones most directly affected by the contamination and by the success or failure of the cleanup technology. In certain cases, they are also the ones who bear the cost of the cleanup or, at the very least, as taxpayers in practice serve as the insurer of last resort.

In 1997, the Tribal and Stakeholder Working Group (TSWG), working with the U.S. Department of Energy (DOE) Office of Science and Technology, developed a set of principles for the integration of tribes and stakeholders into the process of evaluating and developing new technologies for the treatment of mixed low-level waste. Below we discuss the applicable TSWG principles and how they translate to a situation where ISCO is being considered for the remediation of subsurface contamination.

1. Minimize effluents: Clean up contamination as quickly as possible. Avoid fouling. Avoid the generation of reaction side products and new contaminants.
2. Minimize effects on human health and the environment: Protect present and future drinking water supplies and impacts to surface water. Minimize the potential for accidents.
3. Minimize waste generation: Avoid the production of waste from the cleanup effort.
4. Address social, cultural, and spiritual considerations: Minimize land use in the cleanup process. Discuss the transport of chemical reagents with the tribes and stakeholders and adapt such transport to address their concerns. Respect the social, cultural, and spiritual values of specific sites. Minimize noise and traffic. Protect local vistas. Include the costs of tribal and stakeholder participation in cost estimates and budgets. Include the costs of compliance with intergovernmental agreements in cost estimates and budgets.
5. Provide timely, accurate, complete, and understandable information: Explain the technology screening and evaluation process. Provide information about any previous applications of the technology. Provide information about the hazards and risks and also potential hazards and risks, as well as benefits and potential benefits. Keep tribal and stakeholder representatives involved and informed throughout the evaluation, selection, permitting, and deployment processes. Independent technical advisory resources should be made available to the tribes and stakeholders whenever feasible.

6. Incorporate tribal and stakeholder involvement into the responsible parties' procurement process, the permitting process, and the performance evaluation of contractors.

One of the current uncertainties about ISCO is that the ROIs for different types of injections have not been established yet for all soil types and hydrogeological conditions. Recent case studies suggest that, for situations where the soil is tight, the number, geometry, and technique of injection are probably critical to the success or failure of the ISCO treatment. Thus, in turn, the motivation level of the responsible party can be a key factor in the success or failure since some experimentation and multiple attempts with injection configuration and injection method may be necessary.

When a new technology such as ISCO is considered for application to a difficult problem such as DNAPL contamination of subsurface water and soil, there necessarily will be uncertainties about the efficacy and risks of the technology in a given situation. Public acceptance of a new technology is more likely if tribes and stakeholders are involved in a timely and meaningful manner in the evaluation process. Such involvement enables the early identification of significant issues and the joint resolution of these issues. In turn, public involvement promotes faster and more efficacious cleanup of contamination and increases public acceptance of novel approaches to such cleanup.

## **8. CASE STUDIES**

The ITRC ISCO Team presents the following case studies and suggests locations where descriptions of other case studies may be located for review and, perhaps, application at other contaminated sites undergoing remediation. These case studies are presented for the sole reason to illustrate the effective in situ use of an oxidant at a particular place and time, under site-specific hydrogeologic conditions and project operation protocols. Each remediation site is different.

It is the responsibility of each regulatory agency official assigned to an environmental remediation project to establish the criteria for project success. See Table 8.1 and Appendix D for case studies. Published collections of case studies are noted in the Section 9. Persons interested in additional detail concerning these case studies are encouraged to call the identified regulatory agency and/or vendor.



**Table 8-1. Case studies included in Appendix D**

<b>Site</b>	<b>Technology (scale)</b>	<b>Geology</b>	<b>Contaminant</b>
Sunbelt Precision Products, Ft. Lauderdale, FL	Potassium permanganate (full scale)	Medium sands with a coarse sand layer at 57 feet bgs, unconfined aquifer with groundwater 1–5 feet bgs	TCE, TCA
USG Corporation Facility, La Mirada, CA	Potassium permanganate (field pilot)	Silty sand/sandy silt alluvial aquifer, 80–100 feet bgs	PCE
Former Manufacturing Facility, Quincy, MA	Sodium permanganate (full scale)	Fill material beneath a parking lot	PAHs
Union Chemical Company Superfund Site	Potassium permanganate followed by biological reductive dehalogenation (field pilot)	Low-permeability glacial till and fractured schist	TCE, DCE, DCA
Former Gasoline Station, New Castle, IN	Persulfate activated by Fenton's reagent	Native glacial till soils, an unconfined aquifer with groundwater 8–15 feet below grade, including a 4-foot smear zone	BTEX, MTBE
Pierce Service Station, Los Angeles, CA	Hydrogen peroxide (Fenton's) (full scale)	Shallow silty sand alluvial aquifer, 30–45 feet bgs	BTEX, TPH-gas (no MTBE)
Retail Fueling Facility, Westport, MA	Hydrogen peroxide with biological catalysts (full scale)	Fine to coarse sand, with bedrock at 35–50 feet bgs	BTEX and MTBE
Residential Fuel Oil Release, Connecticut	Hydrogen peroxide	Fine to medium sands with numerous cobbles	Fuel oil
Active Retail Gasoline Station, Kenton, DE	Ozone and hydrogen peroxide (full scale)	Medium, well-graded sand with clayey sand to 32 feet bgs	BTEX, MTBE, TAME, TBA
Former Service Station Site, Southeastern PA	Ozone (full scale)	Silty sand and fill material	BTEX, MTBE, PAH (naphthalene)
Former Oil Distribution Terminal Ilion, NY	Ozone and oxygen (full scale)	Silty sand and fill material	PAH (naphthalene)
Former Automobile Sales and Service Center, Bound Brook, NJ	Ozone (full scale)	Glacial till over weathered shale	BTEX
Demolished Retail Service Station, Philadelphia, PA	Ozone (full scale)	Silty sand underlain by fractured schist and shale	Petroleum hydrocarbons
Former Wood Treatment Site, Sonoma County, CA	Ozone	Very heterogeneous stratified silty sands and clays	Pentachlorophenol and creosote (i.e., PAHs)

## 9. REFERENCES

- Adams, C., and S. Randtke. 1992. "Ozonation Byproducts of Atrazine in Synthetic and Natural Waters," *Environmental Science and Technology* **26**: 2218–27.
- Alfaro, M., and R. Wong. 2001. "Laboratory Studies on Fracturing Low-Permeability Soils," *Canadian Geotechnical Journal* **38**: 303–15.
- Amarante, D. 2000. "Applying In Situ Chemical Oxidation," *Pollution Engineering* (February).
- Bajpai, R., M. E. Zappi, and D. Gunnison. 1994. "Additives for Establishment of Biologically Active Zones During In Situ Bioremediation," in *Recombinant Technology DNA II, Annals of the New York Academy of Sciences* **721**: 440–49.
- Baker, D. P. 1997. *Application of Fenton's Reagent as an In Situ Remediation Technique*. M.S. thesis, Massachusetts Institute of Technology, Boston, Mass.
- Banerjee, M., and R. S. Konar. 1984. "Comment on the Paper 'Polymerization of Acrylonitrile Initiated by  $K_2S_2O_8$ -Fe(II) Redox System,'" *Journal of Polymer Science: Polymer Chemistry* **22**: 1193–95.
- Case, T. L. 1997. *Reactive Permanganate Grouts for Horizontal Permeable Barriers and In Situ Treatment of Groundwater*. M.S. Thesis, Colorado School of Mines, Golden, Colo.
- Cherry, J. A., R. W. Gillham, E. G. Anderson, and P. E. Johnson. 1983. "Hydrogeological Studies of a Sand Aquifer at an Abandoned Landfill: 2. Groundwater Monitoring Devices," *Journal of Hydrology* **63**: 31–49.
- Clayton, W. S. 1998. "Ozone and Contaminant Transport during In Situ Ozonation," presented at First International Conference on Remediation of Chlorinated and Recalcitrant Compounds, Monterey, Calif.
- Clayton, W. S. 2000. "Vadose Zone In-Situ Ozonation of Polycyclic Aromatic Hydrocarbons and Pentachlorophenol," in *Vadose Zone Science and Technology Solutions*, B. B. Looney and R. W. Falta, eds. Columbus, Ohio: Battelle Press.
- Cline, S. R., J. M. Giaquinto, M. K. McCracken, D. L. Denton, and R. C. Starr. 1999. *Laboratory Evaluation of In Situ Chemical Oxidation for Groundwater Remediation, Test Area North, Operable Unit 1-07B, Idaho National Engineering and Environmental Laboratory*. ORNL/TM-13711/V1. Oak Ridge, Tenn.: Oak Ridge National Laboratory.
- Crimi, M. L., and R. L. Siegrist. 2003. "Geochemical Effects on Metals Following Permanganate Oxidation of DNAPLs," *Ground Water* **41**(4): 458–69.
- Dahmani, A., K. Huang, G. Hoag, Z. Zhao, and P. Block. 2003. "Degradation of Volatile Organic Compounds with Activated Persulfate," presented at the 19<sup>th</sup> International Soils and Sediments Conference, University of Massachusetts.
- Dennis, P., E. D. Hood, and D. W. Major. 2004. "Impacts of Permanganate on Microbial Population, Diversity, and Dechlorinating Structure," presented at the 4<sup>th</sup> International Conference on Remediation of Chlorinated and Recalcitrant Compounds, Monterey, Calif.
- DOE (U.S. Department of Energy). 1996. *Hydraulic and Pneumatic Fracturing*. Office of Science and Technology Innovative Technology Summary Report.
- Dragun, J., and A. Chiasson. 1991. *Elements in North American Soils*. Greenbelt, Md.: Hazardous Materials Control Resources Institute.
- Drescher, E. A., A. R. Gavaskar, B. M. Sass, L. J. Cumming, M. J. Drescher, and T. Williamson. 1999. "Batch and Column Testing to Evaluate Chemical Oxidation of DNAPL Source Areas," pp. 425–32 in *Proceedings, International Conference on Remediation of Chlorinated and Recalcitrant Compounds*, Monterey, Calif.

- EPA (U.S. Environmental Protection Agency). 1994. *Alternative Methods for Fluid Delivery and Recovery*. EPA/625/R-94/003.
- EPA. 1995a. *In Situ Remediation Technology Status Report: Hydraulic and Pneumatic Fracturing*. EPA/542/K-94-005.
- EPA. 1995b. *State Policies Concerning the use of Injectants for In Situ Ground Water Remediation*. EPA/542/R-96-001. Technology Innovation Office.
- EPA. 1995c. *Surfactant Injection for Ground Water Remediation: State Regulator's Perspectives and Experiences*. EPA/542/R-95-011. Technology Innovation Office.
- EPA. 1996. *State Policy and Regulatory Barriers to In Situ Ground Water Remediation*. EPA/542/R-96-001.
- EPA. 1997a. *Analysis of Selected Enhancements for Soil Vapor Extraction*. EPA/524/R-97/007.
- EPA. 1997b. *Cleaning up the Nation's Waste Sites: Markets and Technology Trends*, 1996 ed. EPA/542/R99-001. Office of Solid Waste and Emergency Response.
- EPA 1998. *In Situ Remediation Technology: In Situ Chemical Oxidation*. EPA/542/R-98-008. Office of Solid Waste and Emergency Response.
- EPA. 2000. *An Analysis of Barriers to Innovative Treatment Technologies: Summary of Existing Studies and Current Initiatives*. EPA/542/B-00-003.
- EPA. 2004. *NRMRL Evaluates Microbial Responses to Groundwater Remediation Technologies*. EPA/54-N-04-002.
- ESTCP (Environmental Security Technology Certification Program). 1999. *Technology Status Review: In Situ Oxidation*. Washington, D.C.
- Federal Remediation Technologies Roundtable. 2002. "In Situ Physical/Chemical Treatment: Hydrofracturing." Available on the Internet at [www.frtr.gov/matrix2/section4/4-39.html](http://www.frtr.gov/matrix2/section4/4-39.html).
- Fleming, E. 2000. *Advanced Oxidation Processes for Remediation of Explosives Contaminated Soil*. Dissertation, Louisiana State University, Baton Rouge.
- Frisbie, S. H. 1992. *The Oxidation of Benzene in Aquifer Water Using Fenton's Reagent: A Feasibility Study*. Ph.D. dissertation, Cornell University, Ithaca, N.Y.
- Gardner F. G., N. E. Korte, J. Strong-Gunderson, R. L. Siegrist, O. R. West, S. R. Cline, and J. Baker. 1998. *Implementation of Deep Soil Mixing at the Kansas City Plant*. ORNL/TM-13532. Oak Ridge, Tenn.: Oak Ridge National Laboratory.
- Gates, D. D., R. L. Siegrist, and S. R. Cline. 1995. "Chemical Oxidation of Contaminants in Clay or Sandy Soil," in *Proceedings, ASCE National Conference on Environmental Engineering*. Pittsburgh: American Society of Civil Engineering.
- Gates-Anderson, D. D., R. L. Siegrist, and S. R. Cline. 2001. "Comparison of Potassium Permanganate and Hydrogen Peroxide as Chemical Oxidants for Organically Contaminated Soils," *Journal of Environmental Engineering* **127**(4): 337–47.
- Glaze, W. H., and J.-W. Kang. 1988. "Advanced Oxidation Processes for Treating Groundwater Contaminated with TCE and PCE: Laboratory Studies," *Journal of the American Water Works Association* **80**(5): 57.
- Greenberg, R., T. Andrews, P. Kakarla, and R. Watts. 1998. "In Situ Fenton-Like Oxidation of Volatile Organics: Laboratory, Pilot, and Full-Scale Demonstrations," *Remediation* **8**(2): 29–42.
- Haines, A. H. 1985. *Methods for the Oxidation of Organic Compounds*. Orlando, Fla.: Academic Press.
- Hartsfield, B. 2000. "In Situ Chemical Additives for Hazardous Waste Site Remediation," Florida Department of Environmental Protection Memorandum (April 4).

- Hill, S. 2000. “Innovative Technologies for Groundwater Cleanup: A Regulatory Perspective,” presented at the IT Corporation seminar “Innovative Technologies for Site Closure” (May 26).
- Hoigne, J., and H. Bader. 1983. “Rate Constants of Reactions of Ozone with Organic and Inorganic Compounds in Water—II, Dissociating Organic Compounds,” *Water Research* **17**: 185–94.
- Hong, A., M. Zappi, C. Kuo, and D. Hill. 1996. “Modeling the Kinetics of Illuminated and Dark Advanced Oxidation Processes,” *Environmental Engineering* **122**(1): 58–62.
- Hood, E. D., N. R. Thomson, D. Grossi, and G. J. Farquhar. 1999. “Experimental Determination of the Kinetic Rate Law for the Oxidation of Perchloroethene by Potassium Permanganate,” *Chemosphere* **40**(12): 1383–88.
- Huang, K., G. E. Hoag, P. Chheda, B. A. Woody, and G. M. Dobbs. 1999. “Kinetic Study of Oxidation of Trichloroethene by Potassium Permanganate,” *Environmental Engineering Science* **16**(4): 265–74.
- Hunkeler, D., and B. L. Parker. 2002. “Monitoring In Situ Oxidation of TCE by Permanganate Using Carbon Isotopes,” in *Treating Dense Nonaqueous Phase Liquids (DNAPLs)*, A. R. Gavaskar and A. S. C. Chen, eds. Proceedings of the 3<sup>rd</sup> International Conference on Remediation of Chlorinated and Recalcitrant Compounds, Columbus, Ohio: Battelle Press.
- IT Corporation. 2000. *Implementation Report of Remediation Technology Screening and Treatability Testing of Possible Remediation Techniques for The Pantex Perched Aquifer*. Amarillo, Tex.: DOE Pantex Plant.
- ITRC (Interstate Technology & Regulatory Council). 1998. *Technical and Regulatory Requirements for Enhanced In Situ Bioremediation of Chlorinated Solvents in Groundwater*. ISB-6.
- ITRC. 2000. *Dense Non-Aqueous Phase Liquids (DNAPLs): Review of Emerging Characterization and Remediation Technologies*. DNAPLs-1.
- Kislenko, V. N., A. A. Berlin, N. V. Litovchenko. 1995. “Kinetics of Glucose Oxidation with Persulfate Ions, Catalyzed by Iron Salts,” *Russian Journal of General Chemistry Part 2* **65**(7): 1092–96.
- Kolthoff, I. M., A. I. Medalia, and H. P. Raaen. 1951. “The Reaction between Ferrous Iron and Peroxides IV. Reaction with Potassium Persulfate,” *Journal of American Chemical Society* **73**: 1733–39.
- Kuo, C., and S. Chen. 1996. “Ozonation and Peroxone Oxidation of Toluene in Aqueous Solutions,” *Industrial and Engineering Chemistry Research* **35**(11): 1206–13.
- Kuo, C., L. Zhong, J. Wang, and M. Zappi. 1997. “Vapor and Liquid Phase Ozonation of Benzene,” *Ozone Science and Engineering* **19**(2): 109–27.
- Kuo, H., L. Zhong, and M. Zappi. 1996. “The Role of the Hydrogen Peroxide-Ozone Reactions in the Advanced Oxidation of Hazardous Pollutants,” pp. 177–190 in *Emerging Technologies in Hazardous Waste Management VI*, D. W. Tedder and F. G. Pohland, eds. American Academy of Environmental Engineers.
- Langlais, B., D. Reckhow, and D. Brink. 1991. *Ozone in Water Treatment*. Chelsea, Mich.: Lewis.
- Lee, D. G. 1980. *The Oxidation of Organic Compounds by Permanganate Ion and Hexavalent Chromium*. LaSalle, Ill.: Open Court.
- Leung, S. W., R. J. Watts, and G. C. Miller. 1992. “Degradation of Perchloroethylene by Fenton’s Reagent: Speciation and Pathway. *Journal of Environmental Quality* **21**: 377–81.
- Liang, C., C. J. Bruell, M. C. Marley, and K. L. Sperry. 2003a. “Persulfate Oxidation for In Situ Remediation of TCE: I. Activated by Ferrous Ion with and without a Persulfate-Thiosulfate Redox Couple,” *Chemosphere* (accepted for publication).

- Liang, C., C. J. Bruell, M. C. Marley, and K. L. Sperry. 2003b. “Persulfate Oxidation for In Situ Remediation of TCE: II. Activated by Chelated Ferrous Ion,” *Chemosphere* (accepted for publication).
- Liang, C., C. J. Bruell, M. C. Marley, and K. L. Sperry. 2003c. “Thermally Activated Persulfate Oxidation of TCE and 1,1,1-TCA in Aqueous Systems and Soil Slurries,” *Soil and Sediment Contamination* **12**(2): 207–28.
- Looney, B. B., and R. W. Falta, eds. 2000. *Vadose Zone Science and Technology Solutions*. Columbus, Ohio: Battelle Press, pp. 1049–54 and 1200–05.
- Lowe, K. S., F. G. Gardner, R. L. Siegrist, and T. C. Houck. 1999. *Field Pilot Test of In Situ Chemical Oxidation through Recirculation Using Vertical Wells at the Portsmouth Gaseous Diffusion Plant*. EPA/625/R-99/012. Washington, D.C.: EPA Office of Research and Development.
- Masten, S., and S. Davies. 1998. “Efficacy of In Situ Oxidation for the Remediation of PAH Contaminated Soils,” *Journal of Contaminant Hydrology* **28**: 327–35.
- McKay, D., A. Hewitt, S. Reitsma, J. LaChance, and R. Baker. 1998. “In Situ Oxidation of Trichloroethene Using Potassium Permanganate: Part 2. Pilot Study,” pp. 377–82 in *Proceedings, International Conference on Remediation of Chlorinated and Recalcitrant Compounds*. Monterey, Calif.
- Mohanty, N., and I. Wei. 1992. “Oxidation of 2,4-Dinitrotoluene using Fenton’s Reagent: Reaction Mechanisms and Their Practical Applications,” *Journal of Hazardous Wastes and Hazardous Material* **10**: 71–183.
- Nelson, C., and R. Brown. 1994. “Adapting Ozonation for Soil and Groundwater Cleanup,” *Chemical Engineering* (November): EE18–EE22.
- Nelson, M. D., B. L. Parker, T. A. Al, J. A. Cherry, and D. Loomer. 2001. “Geochemical Reactions Resulting from In-Situ Oxidation of PCE DNAPL by KMnO<sub>4</sub> in a Sandy Aquifer,” *Environmental Science and Technology* **35**(6): 1266–75.
- Nimmer, M., B. Wayner, and A. Morr. 2000. “In Situ Ozonation of Contaminated Groundwater,” *Environmental Progress* **19**(3): 183–96.
- Nuttal, H. E., S. Alin, W. L. Lundy. 2002. “Remediation of a VOC Plume at an Industrial Park Proceedings” in *Treating Dense Nonaqueous Phase Liquids (DNAPLs)*, A. R. Gavaskar and A. S. C. Chen, eds. Proceedings of the 3<sup>rd</sup> International Conference on Remediation of Chlorinated and Recalcitrant Compounds, Columbus, Ohio: Battelle Press.
- Nuttal, H. E., J. Bowden, and W. L. Lundy. 2002. “Remediation of a PAH Release at a Railroad Switchyard” in *Treating Dense Nonaqueous Phase Liquids (DNAPLs)*, A. R. Gavaskar and A. S. C. Chen, eds. Proceedings of the 3<sup>rd</sup> International Conference on Remediation of Chlorinated and Recalcitrant Compounds, Columbus, Ohio: Battelle Press.
- Oberle, D. W., and D. L. Schroder. 2000. “Design Considerations for In Situ Chemical Oxidation,” in *Proceedings, 2<sup>nd</sup> International Conference on Remediation of Chlorinated and Recalcitrant Compounds*, Monterey, Calif.
- Osgerby, I. T., H. Y. Takemoto, and R. W. Watts. 2002. “PCB Destruction in Pacific Soils Using Modified and Fenton Like Reactions,” in *Treating Dense Nonaqueous Phase Liquids (DNAPLs)*, A. R. Gavaskar and A. S. C. Chen, eds. Proceedings of the 3<sup>rd</sup> International Conference on Remediation of Chlorinated and Recalcitrant Compounds, Columbus, Ohio: Battelle Press.
- Patai, S. 1964. *The Chemistry of Alkenes*. New York: Interscience.
- Parker, B. L., J. A. Cherry, and T. A. Al. 2002. “Passive Permanganate Remediation of a Solvent DNAPL Source Zone,” in *Treating Dense Nonaqueous Phase Liquids (DNAPLs)*, A. R.

- Gavaskar and A. S. C. Chen, eds., Proceedings, 3rd International Conference on Remediation of Chlorinated and Recalcitrant Compounds. Columbus, Ohio: Battelle Press.
- Qiu, Y., C. H. Kuo, and M. Zappi. 2001. "Performance and Simulation of Ozone Absorption and Reactions in a Stirred-Tank Reactor," *Environmental Science and Technology* **35**: 209–15.
- Qui, Y., M. Zappi, C. Kuo, and E. Fleming. 1999. "A Kinetic and Mechanistic Study of the Ozonation of Dichlorophenols in Aqueous Solutions," *Journal of Environmental Engineering* **125**(5): 441–50.
- Rowland, M. A., G. R. Brubaker, K. Kohler, M. Westray, and D. Morris. 2001. "Effects of Potassium Permanganate Oxidation on Subsurface Microbial Activity," presented at In Situ and On-Site Bioremediation: The 6<sup>th</sup> International Symposium.
- Schnarr, M. J., and G. J. Farquhar. 1992. "An In Situ Oxidation Technique to Destroy Residual DNAPL from Soil," presented at the Subsurface Restoration Conference, 3<sup>rd</sup> International Conference on Ground Water Quality, Dallas.
- Schnarr, M. J., C. Truax, G. Farquhar, E. Hood, T. Gonully, and B. Stickney. 1998. "Laboratory and Controlled Field Experimentation Using Potassium Permanganate to Remediate Trichloroethene and Perchloroethene DNAPLs in Porous Media," *Journal of Contaminant Hydrology* **29**: 205–24.
- Schuring, J. R. 2002. *Fracturing Technologies to Enhance Remediation*. TE-02-02. Groundwater Remediation Technologies Analysis Center.
- Siegrist, R. L., K. S. Lowe, L. D. Murdoch, T. L. Case, D. A. Pickering, and T. C. Houck. 1998a. "Horizontal Treatment Barriers of Fracture-Emplaced Iron and Permanganate Particles," pp. 77–82 in *NATO/CCMS Pilot Study Special Session on Treatment Walls and Permeable Reactive Barriers*. EPA 542-R-98-003.
- Siegrist, R. L., K. S. Lowe, L. D. Murdoch, W. W. Slack, and T. C. Houck. 1998b. *X-231A Demonstration of In Situ Remediation of DNAPL Compounds in Low-Permeability Media by Soil Fracturing with Thermally Enhanced Mass Recovery or Reactive Barrier Destruction*. ORNL/TM-13534. Oak Ridge, Tenn.: Oak Ridge National Laboratory.
- Siegrist, R. L., K. S. Lowe, D. R. Smuin, O. R. West, J. S. Gunderson, N. E. Korte, D. A. Pickering, and T. C. Houck. 1998c. *Permeation Dispersal of Reactive Fluids for In Situ Remediation: Field Studies*. ORNL/TM-13596. Oak Ridge, Tenn.: Oak Ridge National Laboratory.
- Siegrist, R. L., K. S. Lowe, L. C. Murdoch, T. L. Case, and D. A. Pickering. 1999. "In Situ Oxidation by Fracture-Emplaced Reactive Solids," *Journal of Environmental Engineering* **125**(5): 429–40.
- Siegrist, R. L., M. A. Urynowicz, and O. R. West. 2000a. *An Overview of In Situ Chemical Oxidation Technology Features and Applications*. EPA/625/R-99/012. Washington, D.C.: EPA Office of Research and Development.
- Siegrist, R. L., M. A. Urynowicz, and O. R. West. 2000b. "In Situ Chemical Oxidation for Remediation of Contaminated Soil and Ground Water," *Ground Water Currents* 37. EPA 542-N-00-006. Washington, D.C.: EPA Office of Solid Waste and Emergency Response.
- Siegrist, R. L., M. A. Urynowicz, O. R. West, M. L. Crimi, and K. S. Lowe (eds.). 2001. *Guidance for In Situ Chemical Oxidation at Contaminated Sites: Technology Overview with a Focus on Permanganate Systems*. Columbus, Ohio: Battelle Press.
- Siegrist, R. L., M. A. Urynowicz, M. L. Crimi, and K. S. Lowe. 2002. "Genesis and Effects of Particles Produced during In Situ Chemical Oxidation Using Permanganate," *Journal of Environmental Engineering* **128**(11): 1068–79.

- Sole, M. 1997. "In Situ Chemical Oxidation Safety Advisory." Bureau of Petroleum Storage Systems, Florida Department of Environmental Protection.
- Spain, J., J. Milligan, D. Downey, and J. Slaughter. 1989. "Excessive Bacterial Decomposition of Hydrogen Peroxide During Enhanced Bioremediation," *Groundwater* **27**: 163–67.
- Stewart, R. 1964. *Oxidation Mechanisms*. New York: W. A. Benjamin.
- Struse, A. M. 1999. M.S. thesis, Colorado School of Mines, Golden, Colo.
- Struse, A. M., and R. L. Siegrist. 2000. "Permanganate Transport and Matrix Interactions in Silty Clay Soils," pp. 67–74 in *Chemical Oxidation and Reactive Barriers*, G. B. Wickramanayake, A. R. Gavaskar, and A. S. C. Chen, eds. Columbus, Ohio: Battelle Press.
- Taube, H., and W. Bray. 1940. "Chain Reactions in Aqueous Solutions Containing Ozone, Hydrogen Peroxide, and Acid," *Journal of the American Chemical Society* **62**: 3357–73.
- Tiang, I., and M. Zappi. 2003. *Chemical Oxidation Enhanced Bioremediation of Polycyclic Aromatic Hydrocarbon Contaminated Sediment*. MSU E-TECH Report, Mississippi State University.
- Trapido, M., J. Veressinina, and R. Munter. 1994. "Ozonation and AOP Treatment of Phenanthrene in Aqueous Solutions," *Ozone Science and Engineering* **16**: 475–85.
- Tratnyek, P. G., T. L. Johnson, S. D. Warner, H. S. Clarke, and J. A. Baker. 1998. "In Situ Treatment of Organics by Sequential Reduction and Oxidation," pp. 371–76 in *Proceedings, 1<sup>st</sup> International Conference on Remediation of Chlorinated and Recalcitrant Compounds*, Monterey, Calif.
- Urynowicz, M. A. 2000. *Reaction Kinetics and Mass Transfer during In Situ Oxidation of Dissolved and DNAPL Trichloroethene and Permanganate*. Ph.D. dissertation, Colorado School of Mines. Golden, Colo.
- Urynowicz, M. A., and R. L. Siegrist. 2000. "Chemical Degradation of TCE DNAPL by Permanganate," pp. 75–82 in *Chemical Oxidation and Reactive Barriers*, G. B. Wickramanayake, A. R. Gavaskar, and A. S. C. Chen, eds. Columbus, Ohio: Battelle Press.
- Vella, P. A., G. Deshinsky, J. E. Boll, J. Munder, and W. M. Joyce. 1990. "Treatment of Low-Level Phenols with Potassium Permanganate," *Research Journal of the Water Pollution Control Federation* **62**(7): 907–14.
- Vella, P. A., and B. Veronda. 1994. "Oxidation of Trichloroethene: A Comparison of Potassium Permanganate and Fenton's Reagent," pp. 62–73 in *In Situ Chemical Oxidation of the Nineties*, Vol. 3. Lancaster, Penn.: Technomic.
- Verschueren, K. 1983. *Handbook of Environmental Data on Organic Chemicals*. New York: Van Nostrand Reinhold, pp. 239, 1105, and 1194.
- Wang, W., M. Zappi, G. Albritton, A. Crawley, J. Singletary, N. Hall, and L. Karr. 2001. *Using Chemical Priming as a Means of Enhancing the Performance of Biocells for Treating Petroleum Products Containing Recalcitrant Species*. MSU E-TECH Report, Mississippi State University.
- Weeks, K. R., C. J. Bruell, and N. Mohanty. 2000. "Use of Fenton's Reagent for the Degradation of TCE in Aqueous Systems and Soil Slurries," *Soil and Sediment Contamination* **9**(4): 331–45.
- West, O. R., S. R. Cline, W. L. Holden, F. G. Gardner, B. M. Schlosser, J. E. Thate, D. A. Pickering, and T. C. Houck. 1998a. *A Full-Scale Field Demonstration of In Situ Chemical Oxidation through Recirculation at the X-701B Site*. ORNL/TM-13556. Oak Ridge, Tenn.: Oak Ridge National Laboratory.
- West, O. R., S. R. Cline, R. L. Siegrist, T. C. Houck, W. L. Holden, F. G. Gardner, and R. M. Schlosser. 1998b. "A Field-Scale Test of In Situ Chemical Oxidation through Recirculation," pp.

- 1051–57 in *Proceedings, Spectrum '98 International Conference on Nuclear and Hazardous Waste Management*, Denver, Colo.
- Yan, Y. E., and F. W. Schwartz. 1996. "In Situ Oxidative Dechlorination of Trichloroethene by Potassium Permanganate, in *Proceedings, 3rd International Conference on AOTs*, Cincinnati.
- Yan, Y. E., and F. W. Schwartz. 1999. "Oxidative Degradation and Kinetics of Chlorinated Ethylenes by Potassium Permanganate," *Journal of Contaminant Hydrology* **37**(3–4): 343–65.
- Yao, C., R. Spangord, and T. Mill. 1996. "Peroxone Oxidation of Aminodinitrotoluenes," in *Proceedings, Second Advanced Oxidation Conference*, San Francisco.
- Yin, Y., and H. E. Allen. 1999. *In Situ Chemical Treatment*. Pittsburgh: Groundwater Remediation Technologies Analysis Center.
- Yuteri, C., and M. Gurol. 1989. "Evaluation of Kinetic Parameters for the Ozonation of Several Drinking Water Contaminants," *Water Science and Technology* **21**: 465–76.
- Zappi, M. 1995. *Peroxone Oxidation of 2,4,6-Trinitrotoluene with and without Sonolytic Catalyzation*. Dissertation, Mississippi State University.
- Zappi, M. 1998. "Treatment of Explosives-Contaminated Groundwaters," pp. 2002–18 in *Encyclopedia of Environmental Analysis and Remediation*. New York: Wiley.
- Zappi, M. 1993. "Innovative Oxidation Technologies," *Ground Water Currents* (December). EPA/542/N-93/011. Washington, D.C.: EPA Office of Solid Waste and Emergency Response.
- Zappi, M., K. White, H. Hwang, R. Bajpai, and M. Qasim. 2000. "The Fate of Hydrogen Peroxide as an Oxygen Source for Bioremediation Activities Within Saturated Aquifer Systems," *Journal of Air and Waste Management* **50**(10): 1818–30.
- Zhang, H., and F. Schwartz. 2000. "Simulation of Oxidative Treatment of Chlorinated Compounds by Permanganate," pp. 1–8 in *Chemical Oxidation and Reactive Barriers: Remediation of Chlorinated and Recalcitrant Compounds (C2-6)*, G. B. Wickramanayake, A. R. Gavaskar, and A. S. C. Chen, eds. Columbus, Ohio: Battelle Press.
- Zhong, L., C. Kuo, and M. Zappi. 1997. "Kinetics of Gas Phase Ozonation of Trichloroethylene," *Journal of Chemical Industry and Engineering (China)* **48**(5): 571–75.

**Many internet sites include some useful information on chemical oxidation. The following sites are listed only to provide a beginning point for readers to start their own research:**

- Comprehensive bibliography by Eric Hood, University of Waterloo:  
[www.civil.uwaterloo.ca/groundwater/oxlitrev.html](http://www.civil.uwaterloo.ca/groundwater/oxlitrev.html)
- Department of Defense program site:  
[www.estcp.org](http://www.estcp.org)
- Federal Remediation Technologies Roundtable Case Studies:  
[bigisland.ttclients.com/frtr/info/abstracts.html](http://bigisland.ttclients.com/frtr/info/abstracts.html)
- Fenton's Reagent and Potassium Permanganate Implementation (PDF files):  
[ost.em.doe.gov/ifd/ost/pubs/scfa.htm](http://ost.em.doe.gov/ifd/ost/pubs/scfa.htm)
- "Field Applications of In Situ Remediation Technologies: Chemical Oxidation" (PDF file):  
[www.gwrtac.org/html/topics/inchemox.htm](http://www.gwrtac.org/html/topics/inchemox.htm)



- ITRC Web site:  
[www.itrcweb.org](http://www.itrcweb.org)
- Site Profiles of Remedial Technologies (EPA):  
[www.clu-in.org/PRODUCTS/siteprof/remdctg.cfm](http://www.clu-in.org/PRODUCTS/siteprof/remdctg.cfm)
- “Technology Status Review, In Situ Oxidation” (PDF file):  
[www.estcp.org/technical\\_documents.htm](http://www.estcp.org/technical_documents.htm)

# **APPENDIX A**

## **Acronyms**

## ACRONYMS

AOC	area of contamination
API	American Petroleum Institute
ASTM	American Society of Testing and Materials
bgs	below ground surface
BTEX	benzene, toluene, ethylbenzene, xylene
BTU	British thermal unit
CB	chlorinated benzene
CERCLA	Comprehensive Environmental Response, Compensation and Liability Act
COC	contaminant of concern
COD	chemical oxygen demand
CPT	cone penetrometer testing
DCA	dichloroethane
DCE	dichloroethene
DGW	discharge to ground water
DNAPL	dense, nonaqueous-phase liquid
DO	dissolved oxygen
DOC	dissolved organic carbon
DOE	U.S. Department of Energy
DQO	data quality objective
DTSC	(California) Department of Toxic Substances Control
EDTA	ethylenediamine tetra-acetic acid
Eh	oxidation reduction potential
EPA	U.S. Environmental Protection Agency
EPCRA	Emergency Planning and Community Right-to-Know Act
EPR	enhanced passive remediation
FID	flame ionization detector
foc	fraction of soil that is organic carbon
GC	gas chromatograph
HPLC	high-performance liquid chromatography
ISCO	in situ chemical oxidation
ITRC	Interstate Technology & Regulatory Council
ITT	innovative treatment technology
KDHE	Kansas Department of Health and Environment
LEL	lower explosive limit
LNAPL	light, nonaqueous-phase liquid
MIP	membrane interface probe
MNA	monitored natural attenuation
MS	mass spectrometer
MSDS	material safety data sheet
MTBE	methyl <i>tert</i> -butyl ether
NAPL	nonaqueous-phase liquid
NJPDES	New Jersey Pollution Discharge Elimination System
NOD	natural oxidant demand

NOM	natural organic matter
ORP	oxygen reduction potential
OST	(U.S. DOE) Office of Science and Technology
PAH	polycyclic aromatic hydrocarbon
PBR	permit by rule
PCB	polychlorinated biphenyl
PCE	perchloroethene or tetrachloroethene
PITT	partitioning interwell tracer test
PLFA	phospholipid fatty acids
PVC	polyvinyl chloride
RCRA	Resource Conservation and Recovery Act
ROI	radius of influence
ROST	rapid optical screening tool
RP	responsible party
SDWA	Safe Drinking Water Act
SOD	soil oxidant demand
SVE	soil vapor extraction
TBA	<i>tert</i> -butyl alcohol
TCA	trichloroethane
TCE	trichloroethene
TDS	total dissolved solids
TIC	total inorganic carbon
TOC	total organic carbon
TPH	total petroleum hydrocarbons
TSWG	Tribal and Stakeholder Working Group
UIC	underground injection control
USDW	underground source of drinking water
UST	underground storage tank
VC	vinyl chloride
VOC	volatile organic compound

## **APPENDIX B**

### **Glossary**

## GLOSSARY

**aldehyde**—a broad class of organic compounds having the generic formula RCHO and characterized by an unsaturated carbonyl group (C = O). They are formed from alcohols by either dehydrogenation or oxidation and thus occupy an intermediate position between primary alcohols and the acids obtained from them by further oxidation.

**alkanes**—a hydrocarbon containing only single carbon-carbon bonds.

**alkenes**—a hydrocarbon containing a double carbon-carbon bond.

**allotrope**—one of several possible forms of a substance.

**ammonium persulfate**—a white crystal obtained from the electrolysis of concentrated solution of ammonium sulfate and recovered by crystallization.

**anion**—a negatively charged ion.

**aquifer**—a water-bearing stratum of permeable rock, sand, or gravel.

**buffering capacity**—a system containing either a weak acid and its salt or a weak base and its salt, which resists changes in pH upon addition of acid or base.

**carboxylic acid**—an organic acid characterized by one or more carboxyl groups (-COOH).

**cation**—a positively charged ion.

**chelating agent**—a compound which forms a chelate with a metal ion.

**cleavage**—the breaking of a chemical bond in a molecule resulting in smaller molecules; of an alkene molecule, to divide in to two compounds at the double bond.

**dichloroethene**—chlorinated ethene used as a degreaser and a breakdown product of PCE and TCE.

**electron**—an elementary particle with a negative charge.

**electrophile**—when an ion or molecule donates a pair of electrons to an atomic nucleus to form a covalent bond, the nucleus that accepts the electrons is called an “electrophile.”

**ethenes**—a colorless flammable gaseous unsaturated hydrocarbon C<sub>2</sub>H<sub>4</sub> that is found in coal gas; can be produced by pyrolysis of petroleum hydrocarbons.

**ferrous salt**—soluble iron salt.

**half-life**—time required to reduce a compounds concentration to half of its initial value.

**hydrogen peroxide**—an unstable compound  $H_2O_2$  used especially as an oxidizing and bleaching agent, an antiseptic, and as a propellant.

**hydrolysis**—a chemical reaction in which water reacts with a compound to produce other compounds; a chemical process of decomposition involving the splitting of a bond and the addition of the hydrogen cation and the hydroxide anion of water.

**hydroxyl**—the chemical group or ion  $-OH$  that consists of one atom of hydrogen and one of oxygen and is neutral or negatively charged.

**hydroxylated**—a molecule that has been formed through the addition of one or more hydroxyl ( $-OH$ ) groups.

**hydroxylation**—a reaction which adds one or more hydroxyl ( $-OH$ ) groups to a molecule.

**hypochlorous acid**—an oxyacid of chlorine containing monovalent chlorine that acts as an oxidizing or reducing agent.

**hypomanganate diester**—short-lived intermediate in the permanganate oxidation of double bonds.

**ketone**—chemical compound with a carbonyl group (with a carbon to oxygen double bond); can be formed by the oxidation of organic matter or alcohols.

**oxidation**—chemical process of using oxygen to remove electrons from an ion, atom, or molecule.

**ozone**— $O_3$ ; highly reactive form of oxygen used for oxidizing, water treatment, and disinfecting.

**ozonide**—compound formed by the addition of ozone to an organic compound.

**perchloroethene**—PCE, or tetrachloroethene, commonly used and environmentally persistent hazardous substance; used as a degreaser and dry cleaning solvent.

**peroxone**—an ozone and hydrogen peroxide oxidation product not requiring a catalyst and used to treat contaminated soil and water.

**potassium permanganate**— $KMnO_4$ , oxidizing agent used to treat contaminated soil and water; characterized by its purple to pink color in solution.

**potassium persulfate**— $K_2S_2O_8$ , oxidizer used in water treatment.

**precipitates**—insoluble products formed by a reaction between two solutes.

**radicals**—highly reactive groups of atoms bonded together with unpaired electrons.

**reactivity**—the propensity of a chemical change or reaction to occur.

**redox**—oxidation-reduction reactions; reactions in which electrons are transferred between reactants.

**saturated aliphatics**—straight, open chain compounds such as the alkanes, methane, butane, propane, and pentane.

**sodium permanganate**— $\text{NaMnO}_4$ ; oxidant used to treat soil or water; more concentrated than potassium permanganate and available in liquid form.

**sodium persulfate**— $\text{Na}_2\text{O}_8\text{S}_2$ ; oxidizer used for soil and water treatment.

**solubility**—the amount of a substance that will dissolve in a given amount of liquid.

**stoichiometry**—the application of the laws of chemistry dealing with proportions and the conservation of mass and energy in chemical reactions.

**sulfate radicals**—an oxidant that is thermally activated; can be produced from sodium persulfate.

**trichloroethene**—TCE, commonly used and environmentally persistent hazardous substance; used as a degreaser; a degradation by-product of the reductive dechlorination of perchloroethene.

**valence state**—energy content of an electron in orbit about an atomic nucleus.

**vinyl chloride**—on environmental sites, this hazardous substance is typically a daughter product of the reductive dechlorination of trichloroethane, trichloroethene, and perchloroethene.



## **APPENDIX C**

### **Regulatory Examples**

## REGULATORY EXAMPLES

### EXAMPLE 1—NEW JERSEY

In New Jersey, we are required to issue New Jersey Pollution Discharge Elimination System (NJPDES) Discharge to Ground Water (DGW) permits for any actual or potential discharge of pollutants to the ground (this would include the federally initiated underground injection control permits). Injection or placement on/in the ground of any chemical has historically been interpreted to be a discharge of pollutants. However, for projects such as ISCO technologies, New Jersey has been using the permit-by-rule (PBR) provisions for pilot tests/feasibility studies to allow the responsible party (RP) to proceed without a final NJPDES permit. PBRs are initially for 90 days; an additional 90 days can be granted for modifications. However, 180 days is the maximum time period allowed, after which a full NJPDES-DGW is required. A PBR allows the New Jersey Department of Environmental Protection (NJDEP) to permit certain discharges just by writing a letter with certain conditions (sampling/technical requirements) to the RP.

An example of the PBR letter can be found below.

\* = Industrial Establishment

RE: Permit-by-Rule Discharge Authorization  
\*  
Municipality, County

Dear \_\_\_\_\_ :

This permit-by-rule discharge authorization is hereby issued pursuant to the New Jersey Pollutant Discharge Elimination System (NJPDES), N.J.A.C. 7:14A-1 et seq. Pursuant to N.J.A.C. 7:14A-22.4(b)5, a Treatment Works Approval is not required for the discharge to ground water authorized in this letter. The discharge approved through this permit-by-rule shall be conducted in conformance with the following requirements:

1. \* is authorized to discharge to the ground waters of the State of New Jersey (State) from:

a pilot treatment plant for the purpose of obtaining engineering design data where the discharge will not last more than 90 days from the first date of discharge, except for discharges related to in situ biotreatability studies where the discharge will not last more than 180 days from the first date of discharge.

monitoring well(s) used to measuring aquifer characteristics where the discharge will not last more than 30 days from the first date of discharge.

a facility or equipment used for monitoring, engineering remedial alternatives analysis, or design studies necessary to evaluate a contaminated site where the discharge will not last more than 90 days from the first date of discharge.

2. The discharge shall follow the proposed scope of work as outlined in the \_\_\_\_\_ dated: \_\_\_\_\_ as approved by the New Jersey Department of Environmental Protection (NJDEP) on \_\_\_\_\_ (oversight document). Failure to comply with the requirements of the oversight document will revoke the permit-by-rule authorization to discharge to the ground waters of the State.
3. \* shall comply with all provisions of the Additional Conditions Applicable to all UIC Permits of the NJPDES regulations, N.J.A.C. 7:14A-5.9, et seq.
4. All design plans and specifications for the treatment and/or reinjection system(s) shall be retained and made available to the NJDEP upon request. System performance will be evaluated against the effluent limits outlined in the oversight document. \* shall meet all effluent limits as outlined in the oversight document.
5. \* shall inspect the discharge weekly for evidence of malfunction including, but not be limited to, breakout, wet areas, ponding, odors, or an overabundance or loss of vegetative cover. At the first indication of a malfunction, \* shall notify the NJDEP pursuant to N.J.A.C. 7:14A-2.5(a)14vi.
6. Seasonal application of water to the land surface via an overland flow or spray irrigation system shall be to a vegetated area and shall not erode the land surface. The application rate must allow for infiltration prior to the property boundary and prior to reaching any surface water body or other receptor. All applications shall cease when the ground is frozen or snow/ice covered.
7. The discharge of water via any discharge to ground water unit shall not adversely impact the behavior of the plume, create an unpermitted discharge to any surface water of the State, create a persistent standing, ponded or surface-flowing fluid condition, or adversely impact a water supply well. The permittee shall take any and all action necessary to prevent ground water contamination from impacting a water supply well.
8. \* is advised that this permit-by-rule authorization is limited to the timeframe noted above. Any discharges after this timeframe will require a full NJPDES permit pursuant to N.J.A.C. 7:14A-1 et seq.
9. Upon completion of the remediation, all temporary discharge to ground water units shall be properly closed and abandoned. Closure plans for the unit(s) shall be submitted to the Case Manager for review and approval under the oversight document. All temporary UIC-Class V injection wells shall be properly abandoned in accordance with N.J.A.C. 7:14A-5.10(a)6.

## **EXAMPLE 2—CALIFORNIA**

California does not have any statewide policy regarding the use of ISCO at groundwater cleanup sites. However, two of the Regional Water Quality Control Boards (Los Angeles Region and the North Coast Region) have recently adopted a General Permit for such activities.

## Background

Responsibility for groundwater cleanup in California is delegated to two CalEPA agencies. The State Water Resources Control Board (State Water Board) regulates groundwater cleanup through its nine semiautonomous Regional Water Quality Control Boards (Regional Water Board). The California Department of Toxic Substances Control (DTSC) regulates groundwater cleanup through its four regions.

The state and regional water boards and DTSC each have jurisdiction over separate groundwater programs but share responsibilities in some areas. The state and regional water boards designate groundwater beneficial uses and are the lead agency regarding regulation of leaking underground storage tanks and municipal landfills. DTSC is the lead agency regarding regulation of hazardous waste (i.e., RCRA) and remediation of Department of Defense Sites. Areas where both agencies share responsibilities concern cleanup of nonfuel groundwater plumes (e.g., VOCs, metals). Typically, a lead agency is appointed to avoid duplication.

1.) In January 2002, the Los Angeles Regional Water Quality Control Board (RWQCB) adopted general waste discharge requirements (WDRs) for in situ technologies. The new General WDRs involve specific technologies such as in situ chemical oxidation and in situ bioremediation. Because these in situ techniques are considered emerging technologies, a number of technical and regulatory issues needed to be addressed by the RWQCB before they would give their approval. Recently published guidance documents on these new technologies available from ITRC and EPA were useful in the transfer of information and helped facilitate RWQCB acceptance of these emerging technologies.

Chemical oxidation technologies permitted under the new General WDRs include the following chemical oxidants: Fenton's reagent or hydrogen peroxide, potassium or sodium permanganate, and sodium persulfate. Bioremediation technologies approved under the new WDRs include the following types of bioenhancement: oxidation/aerobic degradation enhancement, reductive/anaerobic degradation enhancement, nutrient addition, carbon source/electron donor enhancement, and permeable reactive barriers.

By approval of the General WDRs, the cleanup of groundwater-contaminated sites throughout the state should be expedited since the regulatory approval time has been reduced substantially. For example, before the new WDRs took effect, regulatory approval by the RWQCB of an in situ chemical oxidation pilot study took slightly over one year. Following adoption of the WDRs, approval of a similar in situ chemical oxidation study requested by the same contractor was approved in less than 40 days. This example is provided to illustrate the streamlining effect of the new General WDRs.

The in situ technologies approved by the General WDRs can be used for cleanup of groundwater sites contaminated with a variety of organic and inorganic constituents. Chemical oxidation technologies are effective on most organic substances including MTBE, PCE, TCE, BTEX, PAHs, PCBs, phenols, and other organic constituents. Bioremediation and reductive degradation can be effective on inorganic constituents, such as perchlorate, hexavalent chromium, and arsenic, as well as on many organic constituents.

2.) On July 27, 2000, the North Coast Regional Water Board Adopted Order No. R1-2000-51 prescribing general permitting requirements for addition of oxygen releasing compounds to groundwater. The North Coast Regional Water Board covers an area bounded the Oregon state line to the north, Pacific Ocean to the West, the San Francisco Bay Region to the south, and Great Central Valley to the east.

The permit includes the following summary:

The addition of oxygen-releasing compounds to groundwater can be an effective treatment technology capable of reducing the levels of contaminants in groundwater. Oxygen releasing compounds generally consist of magnesium peroxide, calcium peroxide, hydrogen peroxide, permanganates, or other similar compounds. All the compounds are applied to aid in the remediation of petroleum hydrocarbons and other similar contaminants found in groundwater. The addition of any oxygen-releasing compound to groundwater may result in unintended secondary impacts to water quality. Any potential adverse water quality impacts are localized, short term, and do not impact any current or prospective uses of groundwater. Groundwater quality will be monitored before addition of the oxygen-releasing compounds, during treatment, and after treatment is completed to verify no adverse impact to water quality.

Conditions of application for the General Permit are as follows:

1. The discharger shall submit a complete report of waste discharge describing the proposed action including, but not limited to the following: the background water quality of the aquifer into which the oxygen-releasing compounds will be added, including contaminant types, chemical oxygen demand, pH, nutrients, dissolved oxygen, dissolved carbon dioxide, groundwater temperature, iron, oxygen reduction potential, and hydraulic conductivity; characterization of the nature of the groundwater plume; description of the treatment system; and description of the nature and volume of any chemical additives. The report of waste discharge also needs to include information on the possibility of any adverse impacts to groundwater quality, and whether the impacts will be localized and short term and not adversely affect any current or projected uses of the water during the time that impacts are being realized.
2. The discharger shall submit a monitoring proposal to monitor the effectiveness of the treatment system and groundwater quality. The monitoring proposal shall describe the locations to be sampled and will include, but not be limited to the following: an upgradient sampling point, a downgradient sampling point, and sampling points within the contaminated zone and address the nature of the oxygen-releasing compounds and the treated chemicals and any associated breakdown products.
3. The discharger shall submit a sensitive receptor study that includes, but is not limited to, identifying all sensitive receptors within 1500 feet, all beneficial uses of groundwater, and other pertinent information for the specific site.
4. The discharger shall publish a Notice of Intent to comply with these waste discharge requirements in a newspaper of general circulation in the affected area, post a copy of the notice at the site in a prominent location(s), and shall provide notice to contiguous property owners and any interested parties.

5. These Waste Discharge Requirements shall not take effect until the Executive Officer notifies the Discharger in writing that the Waste Discharge Requirements have been issued. The Executive Officer shall not issue the Waste Discharge Requirements until thirty days after the discharger has filed a complete Report of Waste Discharge and published the Notice of Intent. The Waste Discharge Requirements shall not be issued if the Executive Officer finds that there may be significant impacts to water quality, or finds that significant public controversy has arisen or will likely arise from the issuance of these requirements and that these requirements should be considered at a regularly scheduled Regional Water Board meeting.

**EXAMPLE 3—FLORIDA**

EXHIBIT A

Memorandum

Proposed Injection Well(s) for In Situ Aquifer  
Remediation at a Hazardous Waste Remedial Action Site

TO: Richard Deuerling, Mail Station 3530  
Division of Water Resource Management  
Bureau of Water Facilities Regulation  
Underground Injection Control Section

FROM: \_\_\_\_\_  
\_\_\_\_\_  
\_\_\_\_\_

DATE: \_\_\_\_\_

SUBJ: Proposed Injection Well(s) for In Situ Aquifer  
Remediation at a Hazardous Waste Remedial Action Site

Pursuant to Rule 62-528.630(2)(c), F.A.C., inventory information is hereby provided regarding the proposed construction of temporary injection well(s) for the purpose of in situ aquifer remediation at a hazardous waste contaminated site.

Site name: \_\_\_\_\_  
Site address: \_\_\_\_\_  
City/County: \_\_\_\_\_  
Latitude/Longitude: \_\_\_\_\_  
FDEP Facility Number: \_\_\_\_\_

Site owner's name: \_\_\_\_\_  
Site owner's address: \_\_\_\_\_  
\_\_\_\_\_

Well contractor's name: \_\_\_\_\_ (Note 1)

Well contractor's address: \_\_\_\_\_

\_\_\_\_\_  
\_\_\_\_\_  
\_\_\_\_\_  
\_\_\_\_\_  
\_\_\_\_\_

Brief description of the in situ injection-type aquifer remediation project:

\_\_\_\_\_  
\_\_\_\_\_  
\_\_\_\_\_

Summary of major design considerations and features of the project:

Areal extent of contamination (square feet): \_\_\_\_\_

Number of injection wells: \_\_\_\_\_

Composition of injected fluid (See note 2)

(ingredient, wt. %): \_\_\_\_\_

\_\_\_\_\_  
\_\_\_\_\_  
\_\_\_\_\_

Injection volume per well (gallons): \_\_\_\_\_

Single or multiple injection events: \_\_\_\_\_

Injection volume total (all wells, all events): \_\_\_\_\_

A site map showing the areal extent of the groundwater contamination plume and the location and spacing of injection wells and associated monitoring wells, is attached.

The following is a summary description of the affected aquifer:

Name of aquifer: \_\_\_\_\_

Depth to groundwater (feet): \_\_\_\_\_

Aquifer thickness (feet): \_\_\_\_\_

The injection well(s) features are summarized below, and/or a schematic of the injection well(s) is attached.

Direct-push or conventional (circle the appropriate well type)

Diameter of well(s) (i.e., riser pipe & screen)(inches): \_\_\_\_\_

Total depth of well(s) (feet): \_\_\_\_\_

Screened interval: \_\_\_\_\_ to \_\_\_\_\_ feet below surface

Grouted interval: \_\_\_\_\_ to \_\_\_\_\_ feet below surface

Casing diameter, if applicable (inches): \_\_\_\_\_  
Cased depth, if applic.: \_\_\_\_\_ to \_\_\_\_\_ feet below surface  
Casing material, if applic.: \_\_\_\_\_

The in situ injection-type aquifer remediation plan for this contaminated site is intended to meet the groundwater cleanup criteria set forth in the site Decision Memo. Additionally, all other groundwater standards will be met at the time of project completion for any residuals associated with the ingredients of the injected remediation products, and any by-products or intermediates produced as a result of the chemical or biochemical transformation of those ingredients or the contaminants during their use. Applicable primary and secondary drinking water standards are set forth in Chapter 62-550, F.A.C., and additional groundwater quality criteria are set forth in Chapter 62-520, F.A.C.

The remediation plan estimates that site remediation will take \_\_\_\_\_ months. We will notify you if there are any modifications to the remediation strategy which will affect the injection well design or the chemical composition and volume of the injected remediation product(s).

The proposed remediation plan was approved on \_\_\_\_\_ by an RAP approval memo (or other enforceable document). A copy is attached. The remediation system installation is expected to commence within 60 days. Please call me at \_\_\_\_\_ if you require additional information.

Note 1. If an injection well installation contractor has not yet been selected, then indicate the name and address of the project's general remediation contractor/consultant.

Note 2. Complete chemical analysis of injected fluid is required by Chapter 62-528, Florida Administrative Code. Proprietary formulations shall make confidential disclosure. Injected fluids must meet drinking water standards of Chapter 62-550, F.A.C., unless an exemption or variance has been granted.

#### **EXAMPLE 4—KANSAS**

##### **CLASS V UNDERGROUND INJECTION CONTROL PERMIT APPLICATION FOR SUBSURFACE INJECTION OF FLUIDS IN CONJUNCTION WITH A GROUNDWATER REMEDIATION PROJECT**

In conformity with K.S.A. 65-164, 65-165 and 65-171d, the undersigned representing (name of company, corporation or person applying) hereby makes application to the Kansas Department of Health and Environment (KDHE) for a permit to inject nonhazardous fluids into or above an underground source of fresh or usable water by means of an injection well(s) for the purpose of remediation of contamination. This application shall be signed by an executive officer of a level of at least Vice President.

1. The applicant shall provide documentation with this application that KDHE's Bureau of Environmental Remediation has approved a remediation plan that includes the use of the proposed injection well(s). Describe the contamination problem proposed for remediation, including a discussion of the source of the contamination.



2. Describe in detail the function of the well(s) within the scope of the remediation project.

3. Describe the fluids to be injected. Include predicted concentrations of the parameters of concern in the injection fluid. Provide information for each unique injection material or additive, including Material Safety Data Sheets. If materials or additives are mixed prior to injection, provide an analysis of the batch conditions. Otherwise, provide an analysis for each material if materials are to be injected sequentially or manifold mixed during injection. Additional testing of the fluid to be injected may be required after review of the application and pertinent information. All analyses shall be conducted by a laboratory certified by the State of Kansas.

4. Provide a description of the injection zone including lithology, hydrology, porosity, permeability, groundwater flow velocity, transmissivity, specific capacity and coefficient of storage. Include geologic maps, diagrams, geologic cross sections, contamination concentration maps, a piezometric surface map, and results of aquifer pump tests. Provide references for the information submitted.

5. Injection Zones: Depth to: Geologic Name(s) Top Bottom

6. Well Completion

Borehole, casing and cement or grout information.

Borehole casing material weight wall casing type amount cement size lbs/ft thickness seat cement or gauge depth or grouted no.

Grout interval from to

Screen or perforation material: \_\_\_\_\_

Type of screen or perforation openings: \_\_\_\_\_

Screen or perforations intervals:

from \_\_\_\_\_ to \_\_\_\_\_ from \_\_\_\_\_ to \_\_\_\_\_

from \_\_\_\_\_ to \_\_\_\_\_ from \_\_\_\_\_ to \_\_\_\_\_

Gravel pack intervals:

from \_\_\_\_\_ to \_\_\_\_\_ from \_\_\_\_\_ to \_\_\_\_\_

from \_\_\_\_\_ to \_\_\_\_\_ from \_\_\_\_\_ to \_\_\_\_\_

To facilitate grouting, the grouted interval of the well bore shall be drilled to a minimum diameter at least 3 inches greater than the maximum outside diameter of the well casing. Provide information describing the seal to be used on top of the well casing. This seal shall be air- and watertight. If a pitless well adapter shall be so designed and fabricated to prevent soil, subsurface or surface waters from entering the well. If the wellhead is to be completed below the finished ground level the wellhead shall be enclosed in an approved watertight vault.

The top of the vault shall be sloped to allow drainage away from the vault. Provide information describing the design of the vault. Provide an explanation describing why it is necessary to complete the wellhead below ground level.

7. Provide a detailed schematic drawing indicating the proposed well(s) completion at the surface and subsurface.

8. Fluid Injection Rate:

Fluids are to be injected at a minimum rate of \_\_\_\_\_ gallons/day to a maximum rate of \_\_\_\_\_ gallons/day. Demonstrate by appropriate calculations the well(s) is capable of receiving

the proposed maximum fluid injection rate. Provide references for sources of all values used in the calculations.

9. Injection Pressure:

Maximum wellhead injection pressure will be \_\_\_\_\_.

Minimum wellhead injection pressure will be \_\_\_\_\_.

Demonstrate by appropriate calculations the proposed maximum injection pressure will not fracture the injection zone or damage the well components.

10. Discuss the stimulation program for the well(s), including chemical treatments and mechanical means.

11. Discuss the proposed injection procedure for the well(s) and provide a diagram. Describe the injection well pattern. Submit a design plan for the injection system including any pumps, filters, lines, and tanks used in the injection system.

12. Describe the meters or gauges that will be used to measure injection volume, injection rate, and injection pressure. Include the frequency of calibration.

13. Provide a plugging and abandonment plan for the well(s). The plugging plan must include the type of grout, estimated volume of grout, and a description of the grout emplacement procedure. Include a diagram of how the well will be plugged. Guidelines are attached.

14. Provide a map showing the well(s) to be permitted, surface water bodies, springs, mines, quarries, water wells, monitoring wells, withdrawal wells, any other penetrations of the aquifer and other pertinent surface features within the ¼-mile radius area of review. The map must be clear and readable with the ¼-mile radius area of review drawn on the map. A tabulation of data on all the wells within the area of review must be provided including the status, type, construction, date of drilling, location, depth and plugging or completion data. Key the tabulated wells to their location on the map.

15. Provide modeling results for the proposed injection–withdrawal scenario. The model used shall be approved by KDHE’s Bureau of Environmental Remediation. Documentation of this approval shall be provided with this application. Provide a plan for monitoring the effects of injection on the groundwater system in the vicinity of the remediation project. Describe the monitoring wells to be used for this purpose. Include the data to be collected from the monitoring wells, frequency of data collection, data presentation format, and frequency of reporting the data to KDHE.

16. The well(s) shall be constructed by a water well contractor licensed by KDHE. Provide the contractors name, business address, and KDHE license number.

17. The following must be submitted to and approved by KDHE upon completion of the well(s).

A. A log(s) for the well(s)

B. KDHE water well record form WWC-5

C. Complete casing, cementing or grouting, and screening information. Include work reports, work tickets or other documentation.

D. A schematic drawing showing the actual completion of the well(s) at the surface and subsurface, if different from the proposed completion.

**AUTHORITY**

To whom should future correspondence be addressed:

\_\_\_\_\_

(signed) \_\_\_\_\_

I hereby certify that the statements herein are true and correct to the best of my knowledge and belief.

\_\_\_\_\_

Signature of Applicant or Duly Authorized Agent Title

Subscribed and sworn to before me this \_\_\_\_\_ day of \_\_\_\_\_,  
19\_\_\_\_

\_\_\_\_\_  
Notary Public

My Commission Expires \_\_\_6/94

**EXAMPLE 5—MISSOURI**



MISSOURI DEPARTMENT OF NATURAL RESOURCES  
 WATER POLLUTION CONTROL PROGRAM  
 P.O. BOX 176, JEFFERSON CITY, MO 65102

**FORM UIC – APPLICATION FOR CLASS V PERMIT**

FOR AGENCY USE ONLY	
CHECK NO.	
DATE RECEIVED	FEE SUBMITTED

**PART A - DO NOT ATTEMPT TO COMPLETE THIS FORM BEFORE READING THE ACCOMPANYING INSTRUCTIONS.**

**1.00 ACTION REQUESTED**

Construction Permit Application     Operating Permit Application

**2.00 FACILITY INFORMATION**

FACILITY NAME	TELEPHONE NUMBER
ADDRESS	FAX NUMBER
2.1 CONSTRUCTION PERMIT NUMBER, IF APPLICABLE	
2.2 OPERATING PERMIT NUMBER, IF APPLICABLE	
2.3 FACILITY LOCATION (ATTACH A 1" = 2000' SCALE USGS TOPOGRAPHIC MAP SHOWING LOCATION) _____ 1/4, _____ 1/4, SEC. _____ TOWNSHIP _____ RANGE _____, _____ COUNTY	

**3.00 OWNER INFORMATION**

OWNER NAME	TELEPHONE NUMBER
ADDRESS	FAX NUMBER

**4.00 CONTINUING AUTHORITY INFORMATION**

NAME	TELEPHONE NUMBER
ADDRESS	FAX NUMBER

**5.00 FACILITY CONTACT INFORMATION**

NAME	TITLE	TELEPHONE NUMBER
------	-------	------------------

**6.00 GENERAL INFORMATION**

6.1 BRIEF DESCRIPTION OF PURPOSE OF INJECTION. INCLUDE ANALYSES AND CONCENTRATIONS OF ANY POLLUTANTS TO BE REMEDIATED. (ATTACH A SEPARATE SHEET IF NECESSARY)

\_\_\_\_\_

\_\_\_\_\_

\_\_\_\_\_

\_\_\_\_\_

\_\_\_\_\_

\_\_\_\_\_

6.2 BRIEF DESCRIPTION OF FACILITIES TO ACCOMPLISH INJECTION. ATTACH A SIMPLIFIED GEOLOGIC CROSS SECTION SHOWING DEPTH TO BEDROCK, DEPTH TO AQUIFERS, AND DEPTH OF INJECTION. ALSO ATTACH MATERIAL SAFETY DATA SHEETS FOR EACH OF THE INJECTED MATERIALS. IF INJECTION WELL IS TO BE CASED, PROVIDE SCHEMATIC.

\_\_\_\_\_

\_\_\_\_\_

\_\_\_\_\_

\_\_\_\_\_

\_\_\_\_\_

\_\_\_\_\_

6.3 IF BIOLOGICAL AGENTS ARE TO BE INTRODUCED IN THIS PROCESS, A BIOLOGICAL PROFILE AND LITERATURE RESEARCH MUST BE SUBMITTED WITH THIS APPLICATION.

6.4 WILL THIS PROCESS INVOLVE A HAZARDOUS WASTE AS DEFINED IN 10 CSR 25-4.010?  
 YES     NO

6.5 WILL THIS PROCESS RESULT IN DISCHARGE TO SURFACE WATER?  
 YES     NO    If yes, an NPDES permit must be obtained.

**6.00 GENERAL INFORMATION (CONTINUED)**

6.6 HOW MANY TOTAL POUNDS OF CHEMICALS OR BIOLOGIC MATERIALS WILL BE INJECTED?

6.7 IF THIS INJECTION IS INTO AN AQUIFER, HOW WILL THE INJECTED CHEMICALS BE WITHDRAWN OR REDUCED TO INJECTION LEVELS?

\_\_\_\_\_

\_\_\_\_\_

\_\_\_\_\_

\_\_\_\_\_

\_\_\_\_\_

6.8 IF THE CHEMICALS OR BIOLOGIC AGENTS TO BE INJECTED ARE ALREADY PRESENT IN THE GROUNDWATER, GIVE CONCENTRATIONS:

CHEMICAL/BIOLOGIC AGENT	PRE-INJECTION CONCENTRATION (mg/L)
1.	1.
2.	2.
3.	3.

**7.00 OTHER WELL TYPES ON SITE**

YES	NO	TYPE	# AT LOCATION	WELL STATUS		
				ACTIVE	INACTIVE PLUGGED	INACTIVE NOT PLUGGED
<input type="checkbox"/>	<input type="checkbox"/>	ABANDONED WATER WELL		<input type="checkbox"/>	<input type="checkbox"/>	<input type="checkbox"/>
<input type="checkbox"/>	<input type="checkbox"/>	AQUIFER RECHARGE WELL		<input type="checkbox"/>	<input type="checkbox"/>	<input type="checkbox"/>
<input type="checkbox"/>	<input type="checkbox"/>	AQUIFER REMEDIATION WELL		<input type="checkbox"/>	<input type="checkbox"/>	<input type="checkbox"/>
<input type="checkbox"/>	<input type="checkbox"/>	AUTOMOBILE SERVICE STATION DISPOSAL WELL		<input type="checkbox"/>	<input type="checkbox"/>	<input type="checkbox"/>
<input type="checkbox"/>	<input type="checkbox"/>	GROUND SOURCE HEAT PUMP (OPEN LOOP)		<input type="checkbox"/>	<input type="checkbox"/>	<input type="checkbox"/>
<input type="checkbox"/>	<input type="checkbox"/>	IMPROVED SINKHOLE		<input type="checkbox"/>	<input type="checkbox"/>	<input type="checkbox"/>
<input type="checkbox"/>	<input type="checkbox"/>	INDUSTRIAL DRAINAGE WELL		<input type="checkbox"/>	<input type="checkbox"/>	<input type="checkbox"/>
<input type="checkbox"/>	<input type="checkbox"/>	MINE BACKFILL WELL		<input type="checkbox"/>	<input type="checkbox"/>	<input type="checkbox"/>
<input type="checkbox"/>	<input type="checkbox"/>	SEPTIC TANK WITH LATERAL FIELD THAT HAS THE POTENTIAL TO BE USED BY MORE THAN 20 PEOPLE PER DAY		<input type="checkbox"/>	<input type="checkbox"/>	<input type="checkbox"/>
<input type="checkbox"/>	<input type="checkbox"/>	OTHER _____		<input type="checkbox"/>	<input type="checkbox"/>	<input type="checkbox"/>

7.1 WILL INJECTION WELLS BE CASED?

YES  NO

IF YES, A PERMIT MAY BE REQUIRED FROM THE GEOLOGIC SURVEY AND RESOURCE ASSESSMENT DIVISION, P.O. BOX 250, ROLLA, MO, 65402-0250 OR CALL (573) 368-2101.

\_\_\_\_\_

\_\_\_\_\_

\_\_\_\_\_

\_\_\_\_\_

\_\_\_\_\_

**8.00 SIGNATURE INFORMATION**

NAME AND OFFICIAL TITLE (TYPE OR PRINT)	TELEPHONE NUMBER
SIGNATURE	DATE SIGNED

**9.00 DATA**

9.1 THIS SECTION MUST BE COMPLETED IF INJECTION IS INTO AN AQUIFER. IT MUST BE COMPLETED PRIOR TO INJECTION. AT LEAST ONE ANALYSIS MUST BE PERFORMED FOR EACH POLLUTANT LISTED. IF INJECTION IS NOT TO AN AQUIFER, SKIP AND GO TO PART 9.2.

POLLUTANT	MAXIMUM DAILY VALUE	
	CONCENTRATION	MASS
Biochemical Oxygen Demand (BOD)		
Chemical Oxygen Demand (COD)		
Total Organic Carbon (TOC)		
Ammonia as N		
Flow	VALUE	
Temperature (winter)	VALUE	
Temperature (summer)	VALUE	
pH	MINIMUM	MAXIMUM

9.2 MARK "X" IN COLUMN (a) FOR EACH POLLUTANT YOU KNOW OR HAVE REASON TO BELIEVE IS PRESENT. MARK "X" IN COLUMN (b) FOR EACH POLLUTANT YOU BELIEVE TO BE ABSENT. IF YOU MARK COLUMN (a) FOR ANY POLLUTANT, YOU MUST PROVIDE THE RESULTS OF AT LEAST ONE ANALYSIS FOR THAT POLLUTANT. COMPLETE ONE TABLE FOR EACH WELL. SEE THE INSTRUCTIONS FOR ADDITIONAL DETAILS AND REQUIREMENTS.

POLLUTANT AND CAS. NO. (IF AVAILABLE)	MARK "X"		MAXIMUM DAILY VALUE	
	(a) PRESENT	(b) ABSENT	CONCENTRATION	MASS
Bromide (24959-67-9)				
Total Residual Chlorine				
Color				
Fecal Coliform				
Fluoride (16984-48-8)				
Nitrate/Nitrite (as N)				
Nitrogen, Total Organic (as N)				
Oil and Grease				
Total Phosphorus (as P) (7723-14-0)				
Radioactivity				
Alpha, Total				
Beta, Total				
Radium, Total				

**9.00 DATA (CONTINUED)**

POLLUTANT AND CAS. NO. (IF AVAILABLE)	MARK "X"		MAXIMUM DAILY VALUE	
	(a) PRESENT	(b) ABSENT	CONCENTRATION	MASS
Sulfate (as SO <sup>4</sup> ) (14808-79-8)				
Sulfide (as S)				
Sulfite (as SO <sup>3</sup> )				
Surfactants				
Aluminum, Total (7429-90-5)				
Barium, Total (7440-39-3)				
Boron, Total (740-42-8)				
Cobalt, Total (7440-48-4)				
Iron, Total (7439-89-6)				
Magnesium, Total (7439-95-4)				
Molybdenum, Total (7439-98-7)				
Manganese, Total (7439-96-5)				
Tin, Total (7440-31-5)				
Titanium, Total (7440-32-6)				
<b>METALS, CYANIDE, AND TOTAL PHENOLS</b>				
1M. Antimony, Total (7440-36-0)				
2M. Arsenic, Total (7440-38-2)				
3M. Beryllium, Total (7440-41-7)				
4M. Cadmium, Total (7440-43-9)				
5M. Chromium, Total (7440-47-3)				
6M. Copper, Total (7550-50-8)				
7M. Lead, Total (7439-97-6)				
8M. Mercury, Total (7439-97-6)				
9M. Nickel, Total (7440-02-0)				
10M. Selenium, Total (7782-49-2)				
11M. Silver, Total (7440-22-4)				
12M. Thallium, Total (7440-28-0)				
13M. Zinc, Total (7440-66-6)				
14M. Cyanide, Total (57-12-5)				
15M. Phenols, Total				
<b>GC/MS FRACTION – VOLATILE COMPOUNDS</b>				
1V. Acrolein (107-02-8)				
2V. Acrylonitrile (107-13-1)				
3V. Benzene (71-43-2)				
4V. Bis (Chloromethyl) Ether (542-88-1)				
5V. Bromoform (75-25-2)				
6V. Carbon Tetrachloride (56-23-5)				
7V. Chlorobenzene (108-90-7)				

MO 780-1826 (1-03)

**9.00 DATA (CONTINUED)**

POLLUTANT AND CAS. NO. (IF AVAILABLE)	MARK "X"		MAXIMUM DAILY VALUE	
	(a) PRESENT	(b) ABSENT	CONCENTRATION	MASS
<b>GC/MS FRACTION – VOLATILE COMPOUNDS</b>				
8V. Chlodibromomethane (124-48-1)				
9V. Chloroethane (75-00-3)				
10V. 2-Chloroethylvinyl Ether (110-75-8)				
11V. Chloroform (67-66-3)				
12V. Dichlorobromomethane (75-27-4)				
13V. Dichlorodifluoromethane (75-71-8)				
14V. 1,1-Dichloroethane (75-34-3)				
15V. 1,2-Dichloroethane (107-06-2)				
16V. 1,1-Dichloroethylene (75-35-4)				
17V. 1,2-Dichloropropane (78-87-5)				
18V. 1,2-Dichloropropylene (542-75-6)				
19V. Ethylbenzene (100-41-4)				
20V. Methyl Bromide (74-83-9)				
21V. Methyl Chloride (74-87-3)				
22V. Methylene Chloride (75-09-2)				
23V. 1,1,2,2-Tetrachloroethane (79-35-4)				
24V. Tetrachloroethylene (127-18-4)				
25V. Toluene (106-88-3)				
26V. 1,2-Trans Dichloroethylene (156-60-5)				
27V. 1,1,1-Trichloroethane (71-55-6)				
28V. 1,1,2-Trichloroethane (79-00-5)				
29V. Trichloroethylene (79-01-6)				
30V. Trichlorofluoromethane (75-89-4)				
31V. Vinyl Chloride (75-01-4)				
<b>GS/MS FRACTION – ACID COMPOUNDS</b>				
1A. 2-Chloropheno (95-57-8)				
2A. 2,4-Dichlorophenol (120-83-2)				
3A. 2,4-Dimethylphenol (105-67-9)				
4A. 4,6-Dinitro-O-Cresol (534-52-1)				
5A. 2,4-Dinitrophenol (51-28-5)				
6A. 2-Nitrophenol (88-75-5)				
7A. 4-Nitrophenol (100-82-7)				
8A. P-Chloro-M-Cresol (59-50-7)				
9A. Pentachlorophenol (87-86-5)				
10A. Phenol (106-95-2)				
11A. 2,4,6-Trichlorophenol (88-06-2)				

MO 780-1826 (1-03)



**9.00 DATA (CONTINUED)**

POLLUTANT AND CAS. NO. (IF AVAILABLE)	MARK "X"		MAXIMUM DAILY VALUE	
	(a) PRESENT	(b) ABSENT	CONCENTRATION	MASS
<b>GC/MS FRACTION – BASE/NEUTRAL COMPOUNDS</b>				
1B. Acenaphthene (83-32-9)				
2B. Acenaphthylene (208-96-8)				
3B. Anthracene (120-12-7)				
4B. Benzidine (92-87-5)				
5B. Benzo (a) Anthracene (56-55-3)				
6B. Benzo (a) Pyrene (50-32-8)				
7B. 3,4-Benzofluoranthene (205-99-2)				
8B. Benzo (ghi) Perylene (191-24-2)				
9B. Benzo (k) Fluoranthene (207-08-9)				
10B. Bis (2-Chloroethoxy) Methane (111-91-1)				
11B. Bis (2-Chloroethyl) Ether (111-44-4)				
12B. Bis (2-Chloroisopropyl) Ether (39638-32-9)				
13B. Bis (2-Ethylhexyl) Phthalate (117-81-7)				
14B. 4-Bromophenyl Phenyl Ether (101-55-3)				
15B. Butyl Benzyl Phthalate (85-68-7)				
16B. 2-Chloronaphthalene (91-58-7)				
17B. 4-Chloronaphenyl (7005-72-3)				
18B. Chrysene (218-01-9)				
19B. Dibenzo (a,h) Anthracene (53-70-3)				
20B. 1,2-Dichlorobenzene (95-50-1)				
21B. 1,3-Dichlorobenzene (541-73-1)				
22B. 1,4-Dichlorobenzene (106-46-7)				
23B. 3,3-Dichlorobenzidine (91-94-1)				
24B. Diethyl Phthalate (84-66-2)				
25B. Dimethyl Phthalate (113-11-3)				
26B. Di-N-Butyl Phthalate (84-74-2)				
27B. 2,4-Dinitrotoluene (121-14-2)				
28B. 2,6-Dinitrotoluene (606-20-2)				
29B. Di-N-Octyl Phthalate (117-84-0)				
30B. 1,2-Diphenylhydrazine (as Azobenzene) (122-66-7)				
31B. Fluoranthene (206-44-0)				
32B. Fluorene (86-73-7)				
33B. Hexachlorobenzene (118-71-1)				
34B. Hexachlorobutadiene (87-68-3)				
35B. Hexachlorocyclopentadiene (77-47-4)				
36B. Hexachloroethane (67-72-1)				
37B. Indeno (1,2,3-c,d) Pyrene (193-39-5)				

MO 780-1826 (1-03)

**9.00 DATA (CONTINUED)**

POLLUTANT AND CAS. NO. (IF AVAILABLE)	MARK "X"		MAXIMUM DAILY VALUE	
	(a) PRESENT	(b) ABSENT	CONCENTRATION	MASS
<b>GC/MS FRACTION – BASE/NEUTRAL COMPOUNDS (CONTINUED)</b>				
38B. Isophorone (78-59-1)				
39B. Naphthalene (91-20-3)				
40B. Nitrobenzene (98-95-3)				
41B. N-Nitrosodimethylamine (62-75-9)				
42B. N-Nitrosodi-N-Propylamine (621-64-7)				
43B. N-Nitrosodiphenylamine (83-30-6)				
44B. Phenanthrene (85-01-8)				
45B. Pyrene (129-00-0)				
46B. 1,2,4-Trichlorobenzene (120-82-1)				
<b>GC/MS FRACTION – PESTICIDES</b>				
1P. Aldrin (309-00-2)				
2P. $\alpha$ -BHC (319-84-6)				
3P. $\beta$ -BHC (319-85-7)				
4P. $\gamma$ -BHC (58-89-9)				
5P. $\delta$ -BHC (319-86-8)				
6P. Chlordane (57-74-9)				
7P. 4,4-DDT (50-29-3)				
8P. 4,4-DDE (72-55-9)				
9P. 4,4-DDD (72-54-8)				
10P. Dieldrin (60-57-1)				
11P. $\alpha$ -Endosulfan (115-29-7)				
12P. $\beta$ -Endosulfan (115-29-7)				
13P. Endosulfan (1031-07-8)				
14P. Endrin (72-20-8)				
15P. Endrin (7421-93-4)				
16P. Heptachlor (76-44-8)				
17P. Heptachlor Epoxide (1024-57-3)				
18P. PCB-1242 (53469-21-9)				
19P. PCB-1254 (11097-69-1)				
20P. PCB-1221 (11104-28-2)				
21P. PCB-1232 (11141-16-5)				
22P. PCB-1248 (12672-29-6)				
23P. PCB-1260 (11096-82-5)				
24P. PCB-1016 (12674-29-6)				
25P. Toxaphene (8001-35-2)				
<b>DIOXIN</b>				
2,3,7,8-Tetrachlorodibenzo-P-Dioxin (1764-01-6)			DESCRIBE RESULTS	

MO 780-1826 (1-03)

**INSTRUCTIONS FOR FORM UIC – APPLICATION FOR CLASS V PERMIT**

Please read these instructions carefully before completing the application. Send a signed application along with appropriate permit fee to the Water Pollution Control Program, PO Box 176, Jefferson City, MO 65102. Please make your check payable to State of Missouri.

**1.0 ACTION REQUESTED**

Construction Permit Application - Check only if the application is for a permit to construct an injection/recovery well system.  
Operating Permit Application - Check only if the application is for a permit to operate an injection/recovery well system.  
Operating Permit Renewal Application - Check only if the application is for a renewal of an existing permit.

**2.0 FACILITY INFORMATION**

Name - The site-specific name of the facility where the injection/recovery operation is to be conducted.  
Address - Physical address of the site-specific facility.  
2.1 Construction Permit Number - provide the UIC construction permit number that the injection/recovery system was constructed under, if this application is for an operating permit for the same facility.  
2.2 Operating Permit Number - include only the facility's NPDES or UIC permit number(s) if one or more are in effect. If multiple Class V permits are presently in effect, attach a separate list.  
2.3 Facility Location - provide location data.

**3.0 OWNER INFORMATION**

Name the individual, institution, agency or corporation that owns the facility.

**4.0 CONTINUING AUTHORITY INFORMATION**

Name the permanent organization that will serve as the continuing authority for the operation, maintenance, and modernization of the facility.

**5.0 FACILITY CONTACT**

Name the individual within the facility, or operator, most able to supply information about the direct operation of the injection/recovery operation.

**6.0 GENERAL INFORMATION**

6.1 Purpose of injection/recovery - attach separate pages if needed. Include all or portions of an engineering report containing information needed by the owner, continuing authority, and the Department of Natural Resources to fully describe the purpose of the injection/recovery system.  
6.2 Description of the injection/recovery process - attach separate pages if needed. Include all or portions of the engineering report required by #2 above, or submit a separate detailed description of all elements of the product, treatment and injection system required to allow the owner, continuing authority or the Department of Natural Resources to adequately review the system.  
The geologic report should contain, at a minimum: a description of the injection/recovery well pattern; a description of the injection zone including details of lithology, hydrology, and unique features of the injection zone and relevant formation; injection and recovery timeframes; systems for transporting, storing, mixing, metering, and introducing injection materials; recovery fluid gathering systems, treatment or recycling, and disposal systems.  
6.3 Biological Agents - list and describe all biological agents to be injected, including: scientific names; whether or not the agents are native to the formations involved; list of available literature relevant to the use of the agents for the injection operation; their population and nutrient dynamics under proposed operating conditions; discussion and supporting literature regarding potential health and/or environmental impacts of the agents and their metabolites in and downgradient of the injection zone; and after completion of the operation; results of laboratory tests conducted by or for the facility relevant to the injection/recovery operation.  
6.4 Hazardous Waste - will the process involve hazardous wastes as defined by federal and state hazardous waste laws?  
6.5 Surface Discharge - if needed, contact the Water Pollution Control Program for a State Operating Permit application at least 180 days prior to any planned discharge.  
6.6 Give total estimated amounts of materials to be injected.  
6.7 Describe how injected chemicals will be withdrawn to pre-injection levels.  
6.8 Provide analytical data on the pre-injection concentrations of substances to be injected, if these substances are already present in the groundwater. Examples: manganese, if potassium permanganate is injected; or BOD, if a biological agent is to be injected.

**INSTRUCTIONS FOR FORM UIC – APPLICATION FOR CLASS V PERMIT (CONTINUED)**

**7.0 OTHER WELL TYPES ON SITE**

If there are existing wells already on site, give the type, number at location and status.

**8.0 SIGNATURE**

The application **must** be signed by a geologist registered in the State of Missouri or other groundwater professional registered in the State of Missouri.

**9.0 DATA**

9.1 This section must be completed if injection is into an aquifer. It must be completed prior to injection. At least one (1) analysis must be completed for each pollutant listed.

9.2 Mark an "X" for each pollutant believed to be present or absent in the groundwater. If present, at least one (1) analysis must be completed for that pollutant.

**ADDITIONAL FORMS**

To apply for termination of this permit, you must submit a completed Form J. Also attach analyses from samples taken after project completion. These analyses must indicate that concentrations of remediated pollutants have not increased from pre-project concentrations.

## **EXAMPLE 6—TEXAS**

### **INSTRUCTIONS FOR TCEQ CLASS V INJECTION WELL INVENTORY/AUTHORIZATION FORM**

**Submit an original and one copy of the inventory /authorization form to the Industrial and Hazardous Wastes Permits Section, MC-130, P.O. Box 13087, Austin, Texas 78711-3087**

**In addition to the inventory/authorization form the TCEQ requires that a Core Data Form (Form 10400) be submitted on all incoming applications unless a Regulated Entity and Customer Reference Number has been issued by the TCEQ and no core data information has changed. For more information regarding the Core Data Form, call (512) 239-1575 or go to the TCEQ Web site at <http://www.TCEQ.state.tx.us>**

**If you are applying for two or more Class V injection wells that are of similar construction at the same facility you may use one form.**

**If you are applying for Class V injection wells of different construction or at different facilities then use one form per construction type and/or facility.**

**Use the Class V injection well designation key provided at the end of the application to determine the type of injection well for which the application is being submitted and indicate this on the top of the application form (Reg No. 5\_\_\_).**

**Complete Section I for all notifications and Sections II through V as appropriate.**

#### **PLEASE READ . . .**

**The purpose of this form is to serve as the means for the Class V injection well owner or operator to provide notice to the UIC Program of intent to construct, operate, and/or convert a well in accordance with the inventory and approval requirements of 30 Texas Administrative Code 331.10. No Class V injection well may be constructed, operated and/or converted without prior approval from the executive director.**

**SUBMIT TO:**  
 TCEQ  
 Industrial and Hazardous  
 Waste Permits Section  
 MC130  
 PO Box 13087  
 Austin, Texas 78711-3087  
 512/239-6075

**TEXAS COMMISSION ON  
 ENVIRONMENTAL QUALITY**

**CLASS V INJECTION WELL  
 INVENTORY/ AUTHORIZATION FORM**

**Reg. No. 5** \_\_\_\_\_

For TCEQ Use Only  
 Reg. No. \_\_\_\_\_  
 Date Received \_\_\_\_\_  
 Date Authorized \_\_\_\_\_

**Section I General Information**

Provide the information in items 1 through 8

1. TCEQ Program Area (PST, VCP, IHW, etc.), Contact Name and Phone Number
2. Agent/Consultant, Contact Name, Address (Street, City, State, and Zip Code), and Phone Number
3. ____ Owner ____ Operator Owner/Operator, Contact Name, Address (Street, City, State, and Zip Code), and Phone Number
4. Facility Name, Address (Street, City, County, State, and Zip Code) or location description (if no address is available) and Facility Contact Person and Phone Number
5. Latitude and Longitude (degrees-minutes-seconds) and method of determination (GPS, TOPO, etc.) (Attach topographic quadrangle map as attachment A)
6. Type of Well Construction (Vertical Injection, Subsurface Fluid Distribution System, Infiltration Gallery, Temporary Injection Points, etc.) and Number of Injection Wells

7. Detailed Description regarding purpose of Injection System. Attach a Site Map as Attachment B (Attach the Approved Remediation Plan (if appropriate))					
8. Water Well Driller/Installer, Address (Street, City, State, and Zip Code), Phone Number, and License Number					
<b>Section II Proposed Down Hole Design</b> Attach a diagram signed and sealed by a licensed engineer as Attachment C					
Name of String	Size	Setting Depth	Sacks Cement/Grout - Slurry Volume - Top of Cement	Hole Size	Weight PVC/Steel (lbs/ft)
9. Casing					
10. Tubing					
11. Screen					
<b>Section III Proposed Trench System, Subsurface Fluid Distribution System, or Infiltration Gallery</b> Attach a diagram signed and sealed by a licensed engineer as Attachment D					
12. System(s) Dimensions			13. System(s) Construction		
<b>Section IV Site Hydrogeological and Injection Zone Data</b> Provide the information in items 14 through 31					
14. Name of Contaminated Aquifer					
15. Receiving Formation Name of Injection Zone					
16. Well/Trench Total Depth					
17. Surface Elevation					
18. Depth to Ground Water					
19. Injection Zone Depth					

TCEQ 10338, (Revised 7/31/2003)

<p>20. Injection Zone vertically isolated geologically? Y/N Impervious Strata between Injection Zone and nearest Underground Source of Drinking Water  Name: _____  Thickness: _____</p>
<p>21. Provide a list of contaminants and the levels (ppm) in contaminated aquifer  Attach as Attachment E</p>
<p>22. Horizontal and Vertical extent of contamination and injection plume  Attach as Attachment F</p>
<p>23. Formation (Injection Zone) Water Chemistry (Background levels) TDS, etc.  Attach as Attachment G</p>
<p>24. Injection Fluid Chemistry in PPM at point of injection  Attach as Attachment H</p>
<p>25. Lowest Known Depth of Ground Water with &lt; 10,000 PPM TDS</p>
<p>26. Maximum injection Rate/Volume/Pressure</p>
<p>27. Water wells within 1/4 mile radius (attach map as Attachment I)</p>
<p>28. Injection wells within 1/4 mile radius (attach map as Attachment I)</p>
<p>29. Monitor wells within 1/4 mile radius (attach drillers logs and map as Attachment I)</p>
<p>30. Sampling frequency</p>
<p>31. Known hazardous components in injection fluid</p>
<p style="text-align: center;"><b>Section V Site History</b>  Provide the information in items 32 through 35</p>
<p>32. Type of Facility</p>
<p>33. Contamination Dates</p>
<p>34. Original Contamination (VOCs, TPH, BTEX, etc.) and Concentrations  Attach as attachment J</p>

TCEQ 10338, (Revised 7/31/2003)



35. Previous Remediation

Attach results of any previous remediation as attachment K

<<NOTE>> Authorization Form should be completed in detail and authorization given by TCEQ before construction, operation, and/or conversion can begin. Attach additional pages as necessary.

### **Class V Injection Well Designations**

- 5A07..... Heat Pump/AC return (IW used for groundwater to heat and/or cool buildings)
- 5A19.....Industrial Cooling Water Return Flow (IW used to cool industrial process equipment)
- 5B22.....Salt Water Intrusion Barrier (IW used to inject fluids to prevent the intrusion of salt water into an aquifer)
- 5D02.....Storm Water Drainage (IW designed for the disposal of rain water)
- 5D04.....Industrial Stormwater Drainage Wells (IW designed for the disposal of rain water associated with industrial facilities)
- 5F01.....Agricultural Drainage (IW that receive agricultural runoff)
- 5R21.....Aquifer Recharge (IW used to inject fluids to recharge an aquifer)
- 5S23.....Subsidence Control Wells (IW used to control land subsidence caused by ground water withdrawal)
- 5W09..... Untreated Sewage
- 5W10.....Large Capacity Cesspools (Cesspools that are designed for 5,000 gpd or greater)
- 5W11.....Large Capacity Septic systems (Septic systems designed for 5,000 gpd or greater)
- 5W12.....WTPP disposal
- 5W20.....Industrial Process Waste Disposal Wells
- 5W31.....Septic System (Well Disposal method)
- 5W32.....Septic System Drainfield Disposal
- 5X13.....Mine Backfill (IW used to control subsidence, dispose of mining byproducts, and/or fill sections of a mine)
- 5X25.....Experimental Wells (Pilot Test) (IW used to test new technologies or tracer dye studies)

TCEQ 10338, (Revised 7/31/2003)

5X26.....Aquifer Remediation (IW used to clean up, treat, or prevent contamination of a USDW)

5X27.....Other Wells

5X28.....Motor Vehicle Waste Disposal Wells (IW used to dispose of waste from a motor vehicle site - These are currently banned)

5X29.....Abandoned Drinking Water Wells (waste disposal)

## **APPENDIX D**

### **Case Studies**

## CASE STUDIES

**Site:** Sun Belt Precision Products, Fort Lauderdale, Florida

**Contaminants:** TCE, TCA, and degradation products

**Oxidant:** Potassium Permanganate

**Regulatory Agency Contact:** Doug Fitton  
Department of Environmental Protection  
Tallahassee, Florida  
850-245-8927

**Technology Contact:** Beth L. Parker  
University of Waterloo  
Waterloo, Ontario, Canada  
519-888-4567 (ext. 5371)

This case study describes full-scale permanganate remediation of TCE and 1,1,1 TCA contamination in a sand aquifer with a shallow water table where nearly complete groundwater remediation has been achieved and comprehensive performance monitoring was implemented.

### Site Setting

Inadvertent releases to the subsurface of predominantly pure-phase trichloroethene (TCE) with lesser amounts of 1,1,1-trichloroethane (TCA) occurred in the mid-1990s from spigots located on an outside wall of an industrial building. TCE and TCA contaminated soil and groundwater was discovered in 1997, at which time solvent use was discontinued, surficial contaminated soil was excavated, and more extensive groundwater investigations were initiated. The initial direct-push sampling was followed by the installation of a network of conventional 2-inch diameter monitoring wells (with 5- or 10-foot long screens) to delineate the contamination.

Although the conventional monitoring provided information regarding the distribution of affected groundwater and approximate subsurface source zone location, detailed characterization of groundwater was required for the design of an efficient targeted  $\text{KMnO}_4$  injection program. The detailed investigations consisted of continuous coring at two locations in the source area and the installation of depth-discrete multilevel monitoring systems (referred to as cluster wells) similar to those described by Cherry et al. (1983). The 3-D groundwater monitoring network provided for a complete characterization of contaminant distribution and facilitated the design of a comprehensive targeted oxidant distribution network. It was also invaluable in determining the oxidant distribution and the completeness of contaminant oxidation. Figure 1 shows the site layout and the monitoring network along with the date when the maximum TCE concentration was observed at each location.

The site geology consists of medium-grained sands from the ground surface downward with an increasing abundance of hard coquina/limestone fragments in the sand starting at 60 feet below ground surface (ft bgs). The sand is generally homogeneous with the exception of a 8-inch-thick coarse-grained sand interval located at approximately 57 ft bgs. The water table across the site varies 1–5 ft bgs throughout the year. The groundwater flow is predominately to the south, but the net flow is slow due to the small and directionally variable hydraulic gradient.

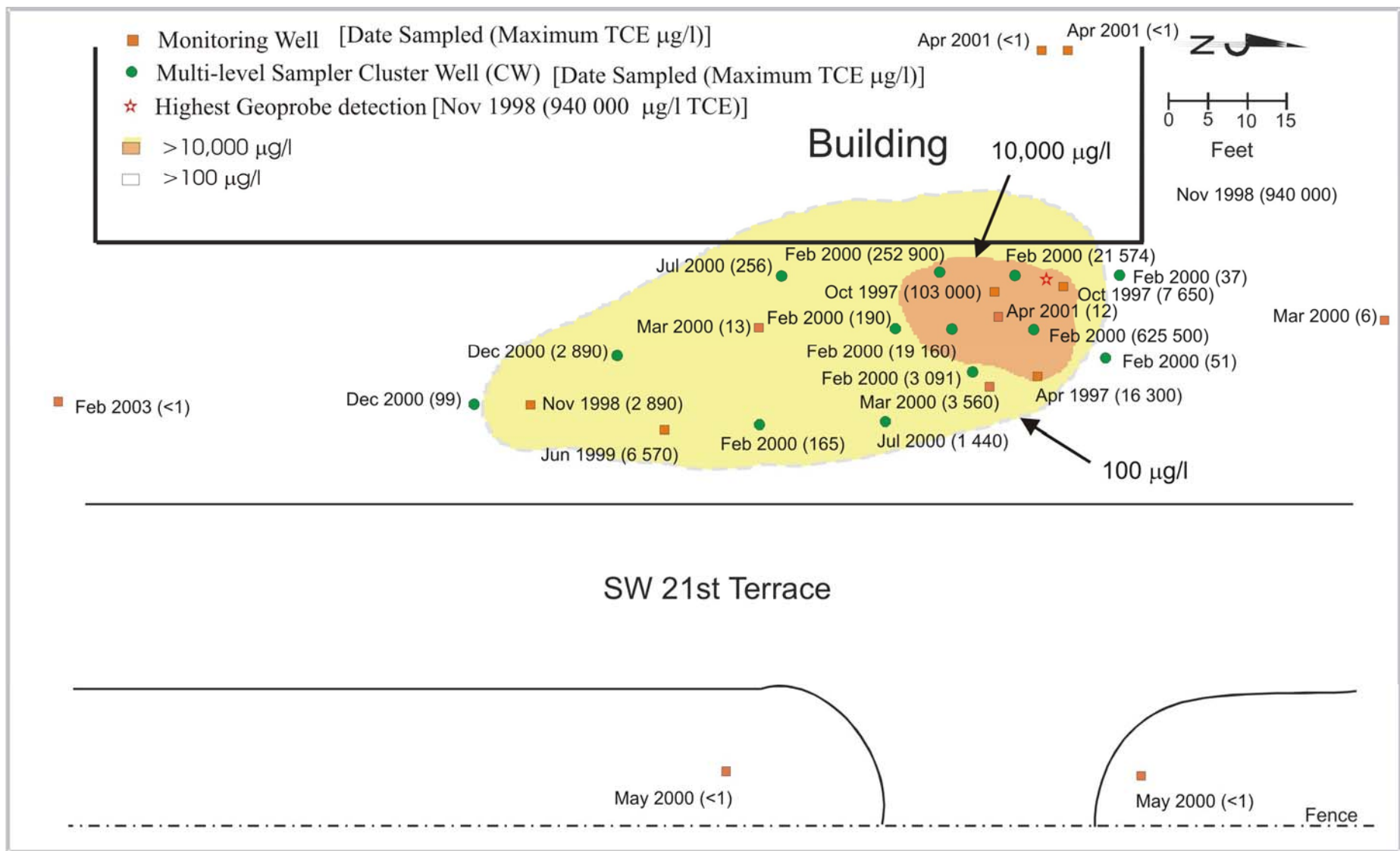

Figure 1. Site map showing monitoring network and the date when the maximum TCE concentration (µg/L) was observed.

## Description of Target Treatment Volume

Figure 2 illustrates the conceptual site model for the TCE contamination and also shows typical pretreatment TCE results obtained from two bundle wells in the source zone. Based on the contaminant distribution, it is conceptualized that the DNAPL descended vertically until it entered the 8-inch-thick coarse sand layer at 57 ft bgs. The permeability contrast provided by this coarse sand layer and the larger retention capacity of this layer likely allowed the DNAPL to spread laterally with minimal DNAPL penetration below this zone. The highest TCE and TCA contaminant concentrations were found 50-70 feet bgs and were limited to an area with a radius of 10–15 feet, shown in Figure 1 as the area within the 10,000- $\mu\text{g/L}$  contour. Concentrations of TCA were consistently 1 to 2 orders of magnitude less than the TCE concentrations. The source zone treatment volume is cylindrical with a radius of 15 feet with a vertical extent 5–70 feet bgs, representing an aquifer volume of 1700  $\text{yd}^3$ . The key treatment area, which encompasses most of the contaminant mass, is approximately 250  $\text{yd}^3$  at a depth of 55–65 feet bgs. Sudan IV testing and soil concentrations collected from the two continuous cores did not directly indicate DNAPL occurrence in any of the samples taken, which were vertically spaced every 6 inches. However, maximum groundwater TCE concentrations measured in the source area prior to treatment were approaching TCE aqueous solubility, such as 625,000  $\mu\text{g/L}$  (at bundle well CW-L) and 940,000  $\mu\text{g/L}$  (using a direct-push sampler). These elevated concentrations along with the deep occurrence of the highest concentrations of both TCE and TCA indicated DNAPL presence, most likely sparsely dispersed globules providing low residual DNAPL saturation of the pore space. DNAPL occurrence was later confirmed by the rebound of TCE and TCA concentrations after initial permanganate injections and by the time trends of carbon isotope values of TCE before and after permanganate treatment episodes (Hunkeler and Parker 2002).

## Remedial Design

The remedial objectives included the destruction of the TCE mass in the DNAPL source zone using  $\text{KMnO}_4$  injections while minimizing the displacement of contaminated groundwater away from the treatment zone. This end was achieved by minimizing the injected treatment solution volume and targeting the injection proximal to, but not immediately in, the highest concentration zones. The objectives were to destroy the contaminant mass in the source zone and allow the remaining low-concentration plume to attenuate by natural processes. Florida Department of Environmental Protection (FLDEP) regulations allow, in certain cases, cessation of active source zone remediation, provided dissolved concentrations in standard monitoring wells are <100 times the maximum contaminant limit (MCL) and sufficient evidence is presented that natural attenuation will soon cause continued attenuation to MCLs without active remediation. The objectives were pursued through injection episodes in which many discrete zones of near-saturation  $\text{KMnO}_4$  solution were created at multiple depths in direct-push holes as illustrated in Figure 3a. Small volumes (relative to the targeted aquifer volume) of  $\text{KMnO}_4$  solution were injected at 50–100 psi, creating discs spaced throughout the treatment zone. Density driven advection, fingering, dispersion, and diffusion, subsequently causes the  $\text{KMnO}_4$  solution to spread, achieving coverage throughout the treatment zone as shown conceptually in Figure 3b. United States and Canadian patents cover this approach.

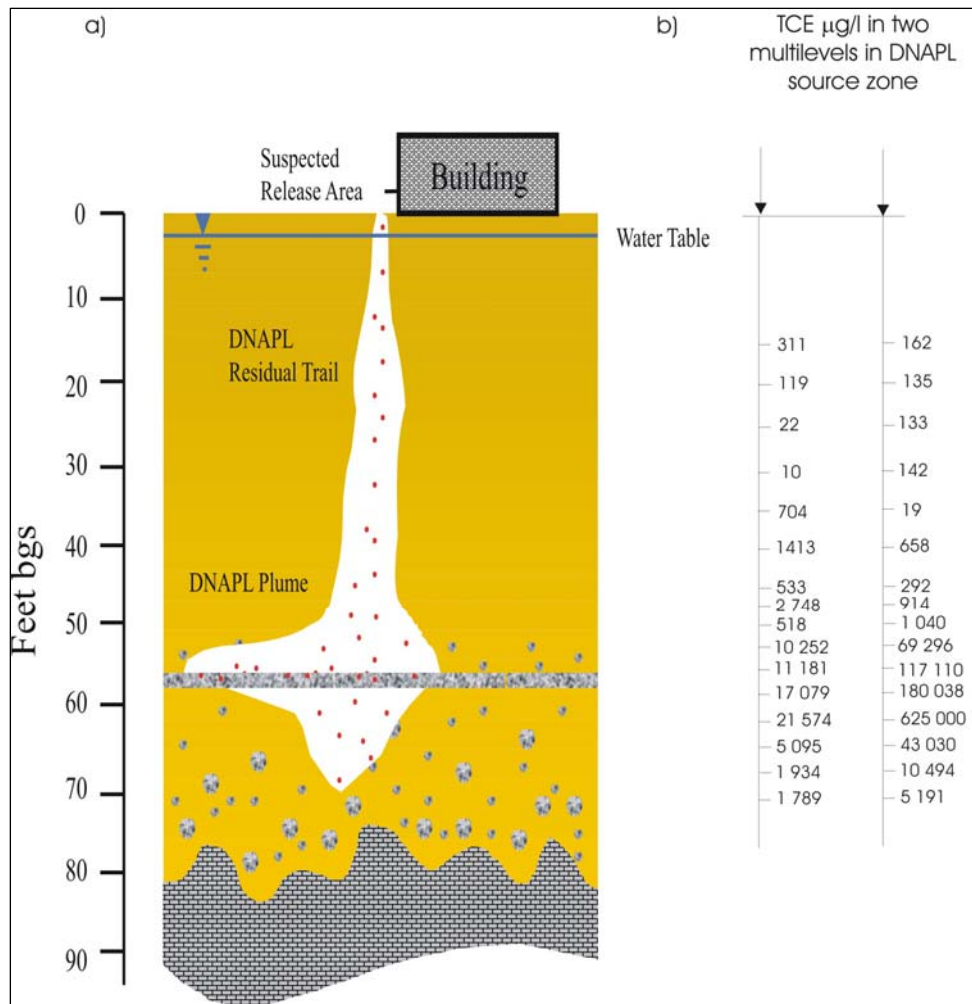

**Figure 2. Nature of the DNAPL source zone.** (a) geology and conceptualization of DNAPL occurrence (b) TCE concentrations in two multilevel systems in the source zone prior to permanganate treatment.

As is always the case for DNAPL source zones, the total contaminant mass in the source zone is not known and therefore the amount of permanganate needed to destroy the DNAPL is unknown. Therefore, the remedial design was founded on the use of a series of injection episodes with detailed monitoring after each episode to assess progress towards complete remediation. Four injection episodes were conducted. The episodes were approximately one to two weeks in duration and were conducted over a two-year period. During the four injection episodes, a total of 3,500 pounds of  $\text{KMnO}_4$  dissolved in 11,500 gallons of water (approximately 4% or 40 g/L concentration) was injected at a total of 21 locations. This injection method results in efficient delivery of  $\text{KMnO}_4$  solution because the injection volumes for each injection episode are small (i.e., approximately 5%) relative to the treatment zone pore volume. Figure 3a illustrates a typical injection episode and Table 1 provides details of each injection event. Sampling for  $\text{KMnO}_4$ , VOCs, and chloride was conducted to monitor remedial progress and streamline future injection events. The injections were conducted under a variance issued by the FLDEP that required the monitoring of several metals identified as components of the  $\text{KMnO}_4$  solution or of the aquifer solids.

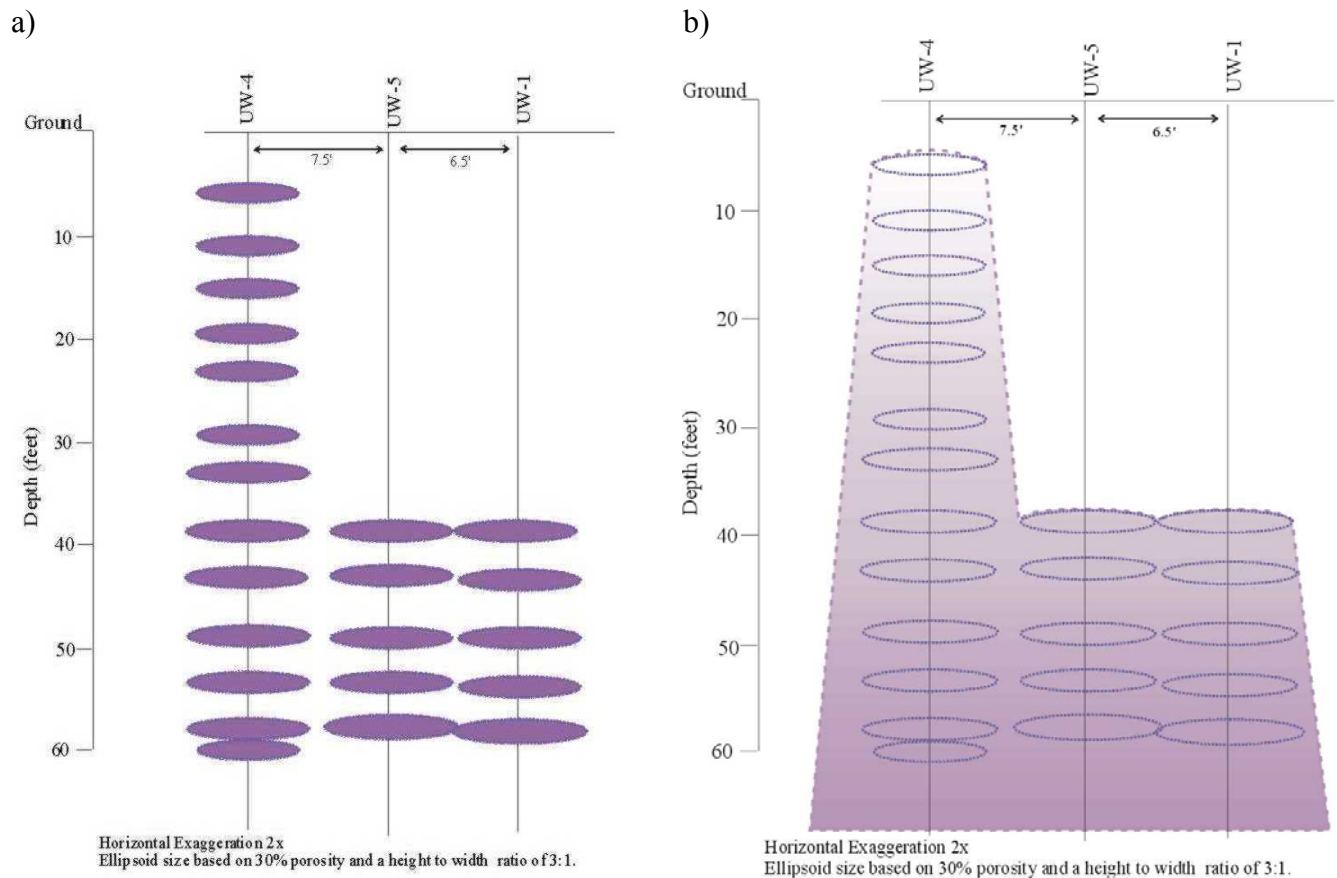

**Figure 3. (a) Conceptual representations of typical MnO<sub>4</sub> injection depths/locations and initial oxidant distribution (total injected volume <5% of treatment zone volume) and (b) dispersed pattern due to density-driven advection, fingering, and dispersion days to weeks following injection.**

**Table 1. Summary table of injection episodes**

Episode	Dates	KMnO <sub>4</sub> (pounds)	Volume of injection (gal)	% of source zone pore volume
1	April 2000	930	3700	5
2	June 2000	1060	2900	4
3	October 2000	800	2600	3.5
4	October 2002	740	2300	3

## Results

Monitoring conducted between the injection episodes showed that the KMnO<sub>4</sub> injections were successful in achieving KMnO<sub>4</sub> distribution throughout the targeted treatment volume. Soon after each injection, KMnO<sub>4</sub> was typically observed at a few sampling points. At later sampling times, KMnO<sub>4</sub> was observed at nearly all sampling points within the target area at one or more times. The



presence of  $\text{KMnO}_4$  was temporary because of its continued downward migration and its consumption by contaminants and natural aquifer solids. Chloride monitoring was used to measure the destruction of TCE because three moles of chloride is produced during the oxidation of one mole of TCE. The chloride values in the source zone were 20–60 mg/L prior to injection and increased to a maximum range of 150–260 mg/L.

The groundwater monitoring for compliance with the FLDEP variance showed no post-treatment exceedances of the specified metals with the exception of iron and manganese. The iron concentrations exceed regulatory criteria but are similar to or lower than background concentrations. The manganese concentrations are currently above regulatory criteria in wells located in the source zone area (i.e., 6 of 15 monitoring locations). However, the most recent monitoring (December 2004) shows significant attenuation of manganese concentrations since the termination of the injection episodes (October 2002).

To assess the efficacy of the  $\text{KMnO}_4$  injections, VOC groundwater concentrations were collected approximately two- and three-years after the last injection episode. Multiple sampling events conducted from the detailed monitoring network provide high certainty assessment data and confirm the efficacy of the injection episodes (shown by the lack of contaminant concentration rebound).

Figure 5a shows pretreatment (February 2000) and 5b post-treatment (February 2003) groundwater concentrations from the monitoring and bundle wells along cross-section C-C'. As is evident from the concentration reductions, the source contamination was thoroughly destroyed with the exception of a 3-foot-thick zone at one bundle well location, which had a TCE concentration of 32,976  $\mu\text{g/L}$  in February 2003 (three months following the fourth and final  $\text{KMnO}_4$  injection). In December 2004, continued attenuation of TCE was observed and the highest concentration from bundle wells was 1,633  $\mu\text{g/L}$ . This attenuation is further evidenced by the concentration of TCE measured in the source area conventional monitoring well (adjacent to the bundle well with the maximum concentration) between July 2004 (190  $\mu\text{g/L}$ ) and November 2004 (4.2  $\mu\text{g/L}$ ). TCA showed similar trends to the TCE; the highest concentration of TCA measured in bundle wells in December 2004 was 141  $\mu\text{g/L}$ . TCA was not detected above method detection limits in the source area conventional monitoring well during the November 2004 sampling event. Based on treatability studies, which show  $\text{KMnO}_4$  does not readily oxidize TCA, the TCA loss is primarily attributed to natural degradation (Parker, Cherry, and AI 2002).

In conclusion,  $\text{KMnO}_4$  successfully destroyed essentially all of the DNAPL present in the source zone with no apparent displacement of contaminant mass to zones outside the treatment zone. Following  $\text{KMnO}_4$  treatment, natural attenuation processes quickly reduced concentrations in the plume to below MCLs for both TCE and TCA. Furthermore, natural attenuation processes have strongly reduced both TCE and TCA concentrations within the treatment zone since  $\text{KMnO}_4$  treatment ceased, and the rate of natural attenuation suggests that MCLs will be achieved in 2005.



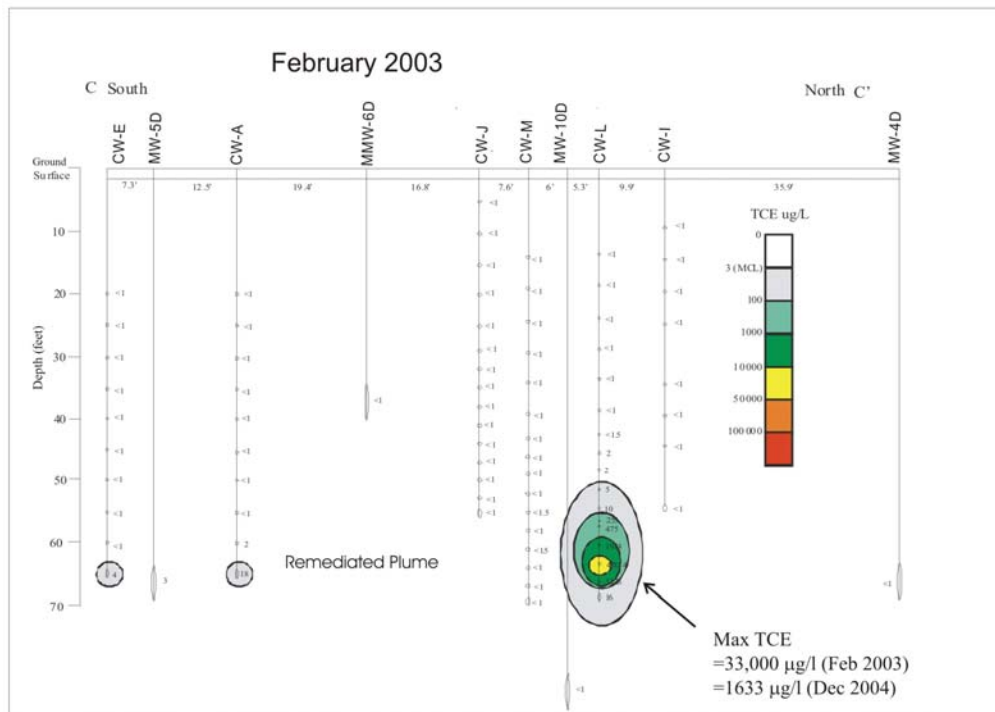
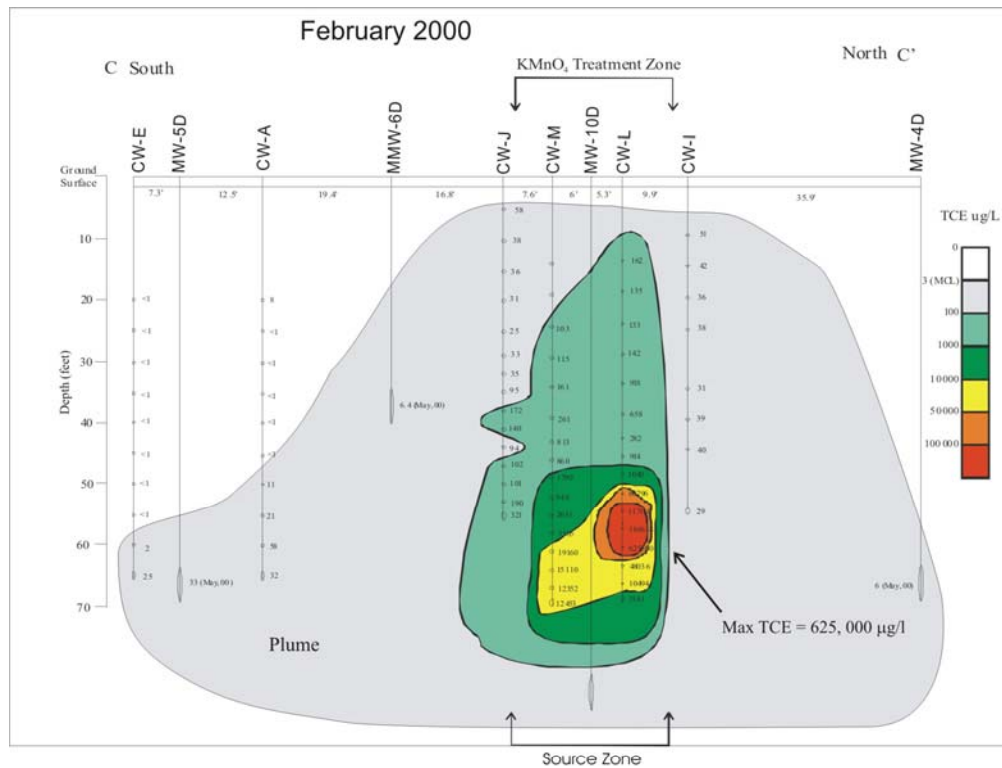

**Figure 5. Comparison of TCE concentrations** (a) before the first KMnO<sub>4</sub> injection (February 2000) and (b) after the final KMnO<sub>4</sub> treatment (February 2003) observed along cross section C-C' through the DNAPL source zone. Comprehensive monitoring conducted in November 2004 showed all TCE and TCA concentrations below MCLs in the plume and a maximum TCE of and TCA of in the former source zone with continued decline to below MCLs expected in 2005.

**Site:** USG Corporation Facility, La Mirada, California (Pilot Test)

**Contaminant:** TCE and 1,1-DCE

**Oxidant:** Potassium Permanganate

**Regulatory Agency Contact:** Mr. Steven Hariri (213) 576-6600  
Los Angeles Regional Water Quality Control Board

**Consultant:** Mr. Gary Cronk (949) 222-9133  
MECX, LLC

## Site Setting

The aquifer sediments comprise mostly silty sands and sandy silts interbedded with clays and clayey silts. The aquifer has a relatively high hydraulic conductivity of 18 feet/day. Groundwater flows towards the northeast with a gradient of 0.033 feet/foot and a velocity estimated to be 0.17 feet/day. The Los Angeles Regional Water Quality Control Board (LARWQCB) considers the affected groundwater aquifer a potential drinking water source. The aquifer thickness is approximately 25 feet (depths of 80–105 feet bgs) and is considered part of the regional Artesia aquifer. No sensitive receptors other than those associated with a drinking water source were identified in the immediate vicinity of the site.

## Description of Target Treatment Volume

The plume, consisting of groundwater contaminated with TCE and 1,1-DCE, was present at a depth of approximately 80–105 feet bgs. The areal extent of the entire plume measured approximately 55,000 square feet, although this pilot test was performed to determine the effects of ISCO treatment on a much smaller portion of the plume, approximated at 1375 square feet. The highest pretreatment level of TCE was 450 µg/L and of 1,1-DCE was 700 µg/L.

## Remedial Design

A field pilot test was performed using a single groundwater well to demonstrate the effectiveness of potassium permanganate (KMnO<sub>4</sub>) to remediate a contaminated alluvial aquifer located beneath an industrial facility in La Mirada. This was the first ISCO project performed in the Los Angeles basin, following the January 2002 approval by the LARWQCB of General Waste Discharge Requirements for in situ technologies. The pilot test consisted of six injections each of 1,500 gallons of potassium permanganate (KMnO<sub>4</sub>) solution (up to 5% by weight) into a single groundwater injection well (screened interval of 80–100 feet bgs) (total injection quantity of 9,000 gallons). The radius of influence was determined to be approximately 35 feet by field measurement of water quality changes (i.e., redox, specific conductance, and turbidity), laboratory analysis of permanganate ion, and observation of “pink water” in the surrounding wells. The actual treatment radius was extended another 15 feet by inducing a hydraulic gradient via the pumping of groundwater from a downgradient well. Eleven existing wells were used as monitoring wells over a six-month monitoring period. Field measurements of specific conductance, oxidation-reduction potential, turbidity, and color (pink or purple for presence of permanganate) were used to assess oxidant dispersion and consumption of permanganate.

The primary goals of the pilot test were threefold: evaluate the destruction of chlorinated ethenes (TCE and 1,1-DCE), measure secondary water quality effects, and develop design data for scale-up to a site-wide permanganate treatment.

## Results

Significant reductions of TCE and 1,1-DCE concentrations, from 86% to 100%, were detected shortly following the injections. The TCE concentrations in the three closest monitoring wells, within 35 feet of the injection well were all reduced to nondetectable (ND) levels ( $<1.0 \mu\text{g/L}$ ) during the first 70 days of the pilot test. This included a maximum reduction of TCE from  $280 \mu\text{g/L}$  to ND ( $<1 \mu\text{g/L}$ ). Over the next 90 days, three additional wells (45 to 50 feet away) also began to show significant TCE reductions, with a maximum decrease in TCE from  $450$  to  $65 \mu\text{g/L}$ . Effective treatment of 1,1-DCE was also observed in five wells, declining from  $270 \mu\text{g/L}$  to ND ( $<1.0 \mu\text{g/L}$ ) in one well and from  $700$  to  $19 \mu\text{g/L}$  in another well. No significant rebound of TCE or 1,1-DCE levels has been monitored for 12 months following the pilot test.

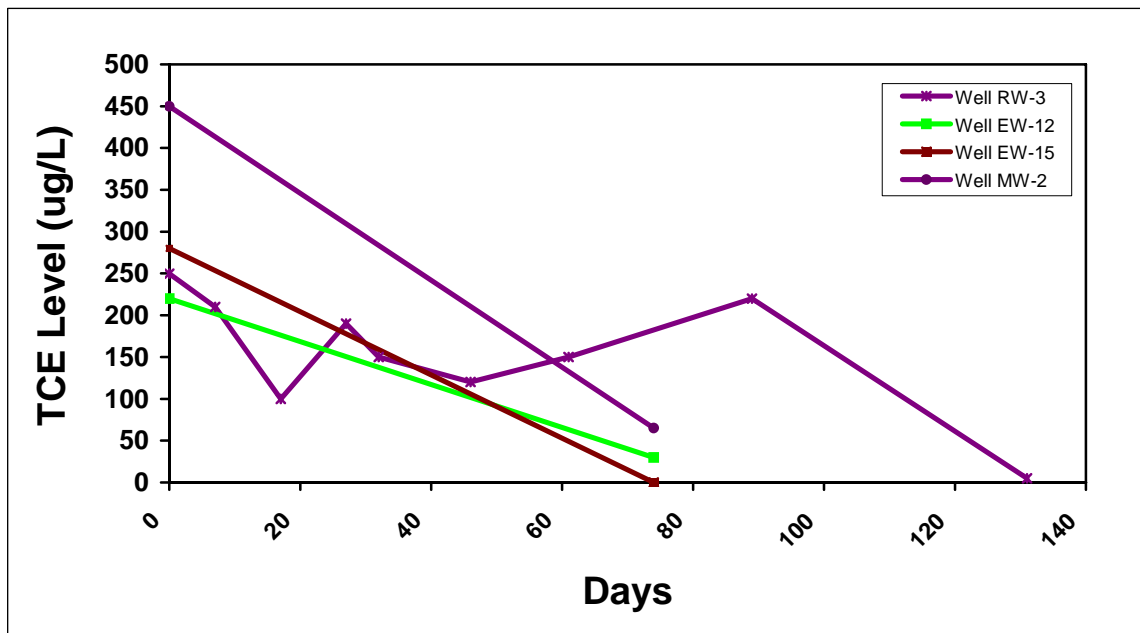

Figure 1. Decline in TCE levels following  $\text{KMnO}_4$  injections.

## Cost

The pilot study also illustrated the cost-effective use of existing wells for monitoring purposes in lieu of direct-push borings or new well installations. The total costs for this pilot test was approximately \$160,000, or about \$52 per cubic yard by volume. Based upon the successful pilot test, a full-scale application of  $\text{KMnO}_4$  at the site will be implemented in cooperation with the RWQCB. The estimated costs of the full-scale treatment will be about \$200,000.

**Site:** Former Manufacturing Facility; Quincy, Massachusetts

**Contaminant:** Polyaromatic Hydrocarbons

**Oxidant:** Sodium Permanganate

**Regulatory Agency Contact:** Charlie Lindberg (781) 278-3830  
Massachusetts Department of Environmental Quality

**Technology Contact:** Mr. Tim Pac (617) 646-7862  
Environmental Resources Mgt.

## **Site Setting**

This site was an industrial manufacturing facility 1951–2000. The site is classified as Tier II with the Massachusetts Department of Environmental Protection (MADEP) following the detection of VOCs in soil and groundwater at the site during the mid-1980s. The subsurface media of concern for the project includes fill material beneath the parking area in the eastern portion of the site. The lithology is mixed sandy fill (from building construction) above silt (providing basal confining later), and the site was a former wetland area. Groundwater flow is northeast toward a fully culverized stream, and the gradient is generally nearly flat across the site. The velocity is not documented but estimated as <100 feet/year.

## **Description of Target Treatment Volume**

In April 1999, PAHs were detected at concentrations above the Massachusetts Contingency Plan (MCP) reportable concentrations for Category S-2 type soils (refers to soils in passive contact only). Subsequently, a Class B Response Action Outcome was filed in May of 2000 for residual petroleum hydrocarbons and lead (volume of treatment zone not available.) Upon subsequent investigation, the contaminants of concern included chlorinated volatile organic compounds and their reductive biological degradation components, in decreasing quantities, PCE, TCE, DCE (isomers) and VC.

## **Remedial Design**

The remediation effort was designed for two phases, with an initial two-part pilot phase (in 2000 and in 2001) followed by full-scale remediation of the site in 2002. Chemical oxidation using permanganate was implemented at this site as a supplemental remedial technology (to the existing pump-and-treat system) to accelerate the remedial process. In accordance with Application of Remedial Additives section (310 CMR 40.0046) of the MCP, remedial additives were to be added to the subsurface, provided that such additives or by-products would not impair groundwater quality or endanger water supplies. The project engineer had to achieve MADEP approval for the addition of permanganate as the remedial alternative selected for the site allowing pilot and additional remediation to proceed.

## **2000 Pilot Test**

The first permanganate pilot study was completed in December 2000 to verify that the oxidative technology was applicable for the site. Baseline monitoring/sampling for physical parameters was conducted in November and December 2000 prior to permanganate addition on December 6, 2000. Groundwater samples were analyzed for VOCs, COD, chloride, color, and selected dissolved metals

(copper, iron, manganese, and sodium only). Sodium permanganate additions were conducted into five wells using approximately 4,200 pounds of oxidant.



Post-addition groundwater quality monitoring for physical parameters was conducted on a weekly basis for five weeks and biweekly for the duration of the release abatement measure (RAM). The overall decrease in color (i.e., unreacted permanganate), permanganate concentration (i.e., measured by colorimetry) and physical parameters (e.g., pH and ORP) generally trend toward equilibrium (i.e., baseline). While the permanganate continued to react slowly, only limited VOC mass was present to facilitate this process. This fact, coupled with the slow to stagnant groundwater flow, was not conducive to advective transport from the application wells, resulting in the persistence of unreacted permanganate in the pilot area. Typical radius of influence observed during the applications tended to be 10–15 feet, although a significant portion of the additive flowed along permeable backfill zones in the trenches interconnecting the application wells (installed as part of the remedial system). Groundwater samples collected at Weeks 5 and 12 indicated decreased concentrations of VOCs in the application wells. In locations where sufficient VOC mass was present, the permanganate was quickly reacted and the wells returned to clear, with the commensurate rebound in concentrations.

### **2001 Pilot Test**

A second pilot application was conducted to test the addition of a small quantity of sodium permanganate (400 pounds of permanganate) into an area that has not been extensively disturbed by prior utility/piping installations (low-permeable areas). Two injection methods were tested as part of the expanded pilot study to evaluate the relative effectiveness of each method: a  $\frac{3}{4}$ -inch driven steel point and a 2-inch PVC injection well installed using conventional hollow-stem drilling methods. Composite soils from the boring were prepared and analyzed for soil oxidant demand using a field test kit developed by IT. The results of the second application indicated an approximate 15-foot radius of

influence (typical for what was seen in preceding additions), confirming that application into small-diameter points was a viable technique for distributing permanganate at the site.

These RAM activities indicated that the application of sodium permanganate significantly reduced VOCs in local groundwater within the treatment areas and that oxidation provided a viable technology for site remediation. Based on these results, Raytheon elected to expand the chemical oxidation activities with the objective of further reducing VOC mass at the site.



## Results

Permanganate pilot studies were completed between December 2000 and April 2001 to verify that the oxidative technology was applicable for the site. The results from these studies indicated that the application of sodium permanganate significantly reduced VOCs in local groundwater within the treatment areas and that oxidation provided a viable technology for site remediation. Based on these results, Raytheon elected to expand the chemical oxidation activities with the objective of further reducing VOC mass at the site. The objective of the 2001 Remedial Work Plan was to conduct applications of sodium and potassium permanganate to aid in the reduction of VOC concentrations in groundwater.

### 2001 Remedial Work Plan

Four areas were identified for treatment encompassing approximately 1 acre. Permanganate was added into a network of 114 temporary injection points constructed of small-diameter PVC and/or steel well materials, installed to depths of approximately 12–14 feet bgs by direct-push methods. Each addition point was completed using a 5-foot length of screen set below the water table within a sand layer and partially within a silt and clay layer below the sand. Eight soil borings were completed to evaluate the occurrence of organic soils; provide aliquots of soil for soil oxidant demand testing; and evaluate the extent of DNAPL present in one location. Also, due to the limited injection capacities in one portion of the site, three additional larger-diameter points were installed in this area by vacuum excavation methods.

Baseline groundwater quality samples were collected during July, August and September 2001 and submitted for VOCs with select samples for analyses for COD, Cl<sup>-</sup>, color and the dissolved metals (Na, K, Fe and Mn). Physical chemistry was measured baseline and weekly using field instrumentation for ORP, DO, pH and SC. Sodium and potassium permanganate dosages were applied



directly into designated addition points via a prorated application scheme using a combination of gravity feed and positive displacement pumps. Where multiple points were collocated, additions were completed using a temporary manifold and multipoint pressurized local distributor system. In limited access, remote, or specific locations, additions were conducted using portable equipment and/or temporary piping. Oxidant was applied to the application points at various pressures, flow rates, and volumes, depending on the VOC concentrations and target application volume, the estimated area of influence, distance from the mixing and distribution system, oxidant and dilution, soil permeability, breakout potential, adjacent well locations, and well capacity. Field staff remained on site throughout the site activities, including mixing permanganate, coordination of site logistics for storage and conveyance, inspection of all piping and application points at least daily, recording and adjusting application rate(s) as needed, collecting water chemistry data to monitor progress, maintain safe work area, and optimize additions. A total of approximately 44,680 pounds of permanganate was applied through 97 points during the 10 weeks of addition, beginning September 17, 2001 and ending November 30, 2001. Following the completion of the application, all storage vessels, mixing equipment, conveyance piping and appurtenances, monitoring facilities and support equipment were cleaned and either returned to vendors, removed from the site for reuse, or appropriately disposed of as nonhazardous solid waste. No hazardous wastes were generated during this remedial effort.

Several groundwater monitoring events were conducted as part of the post-application sampling activities. Initial post-application sampling was performed mid-October 2001, with additional sampling in December 2001 and March 2002. Post-application monitoring indicated decreased VOC concentrations in both application and area monitoring wells. Post-application monitoring has not revealed measurable or significant rebound. Several hot spot areas of persistent VOCs were identified. These areas correspond to locations where hydraulic capacity was insufficient to allow proper dosing and have been scheduled for additional soil treatment as a direct application.

## **2002 Remedial Work Plan**

The objective of these addendum activities is to conduct targeted permanganate application in limited areas of the site identified to contain residual VOCs. Although these areas were treated during the Remedial Work Plan activities, post-application monitoring indicated that VOC levels persisted at these discrete locations. Additional application of sodium permanganate to the saturated soils at select site locations has been selected to aid in the reduction of residual VOC concentrations in groundwater and residual material adsorbed to the soil in these limited areas.

Targeted applications will be conducted using open excavation and direct additions of liquid sodium permanganate to saturated soils. Baseline groundwater sampling was conducted in March 2002 to provide precharacterization data and dosage estimates. Sodium permanganate was added to typical 15-by 3-foot excavated trenches to begin the oxidizing reaction with the organic compounds in groundwater and soil. Trenches were excavated to depths of approximately 6 feet below groundwater. Sodium permanganate, delivered to the site in bulk totes, was then directly applied to a stone backfill, where it was mixed with groundwater in situ to produce a dilute solution. Groundwater monitoring was continued as described in previous RAM status reports. A status and/or completion report was prepared with a summary and evaluation of the findings. In addition, conclusions and recommendations on the remediation program were included in the report.

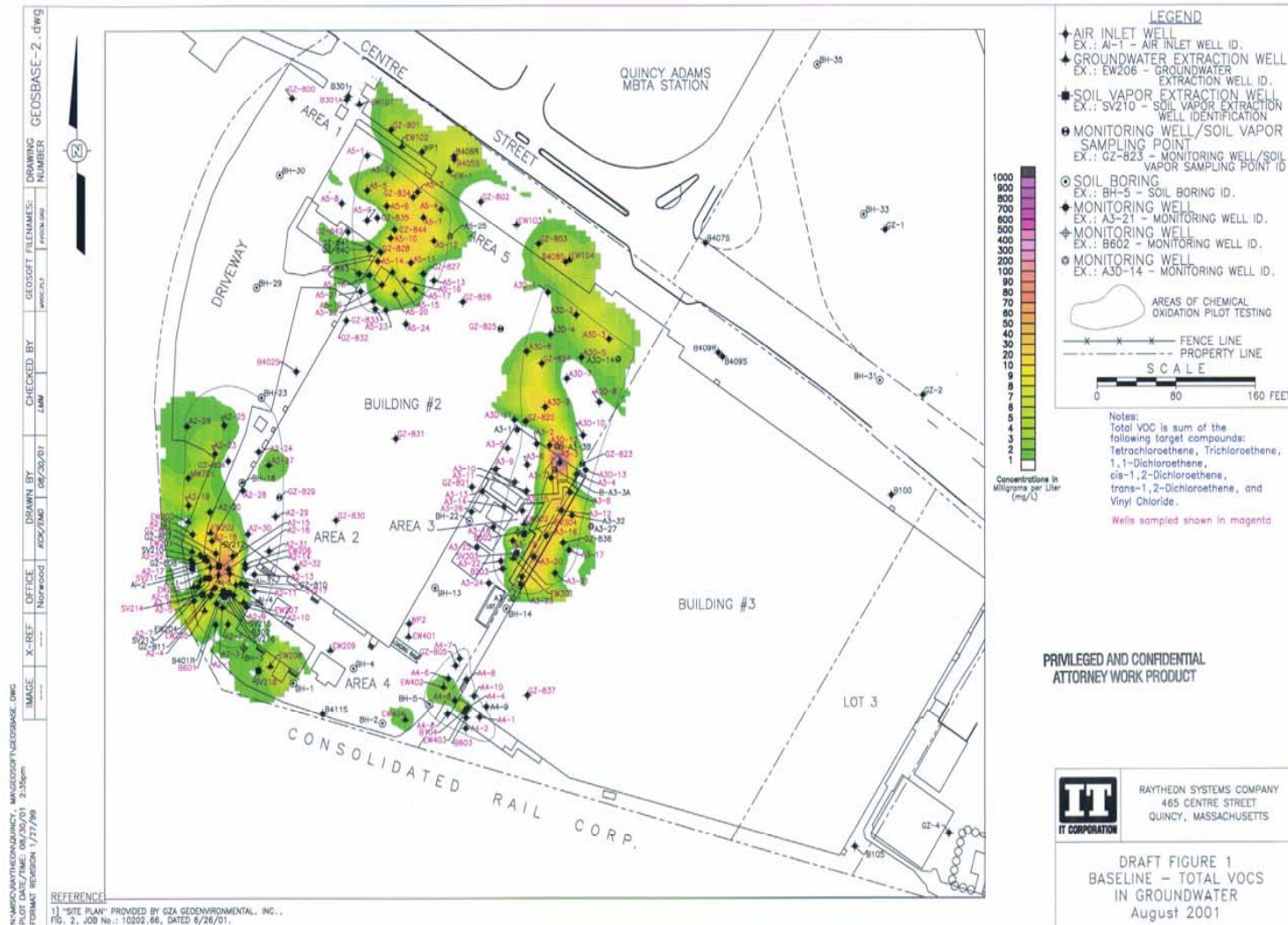

Before treatment (total VOCs >1 ppm)

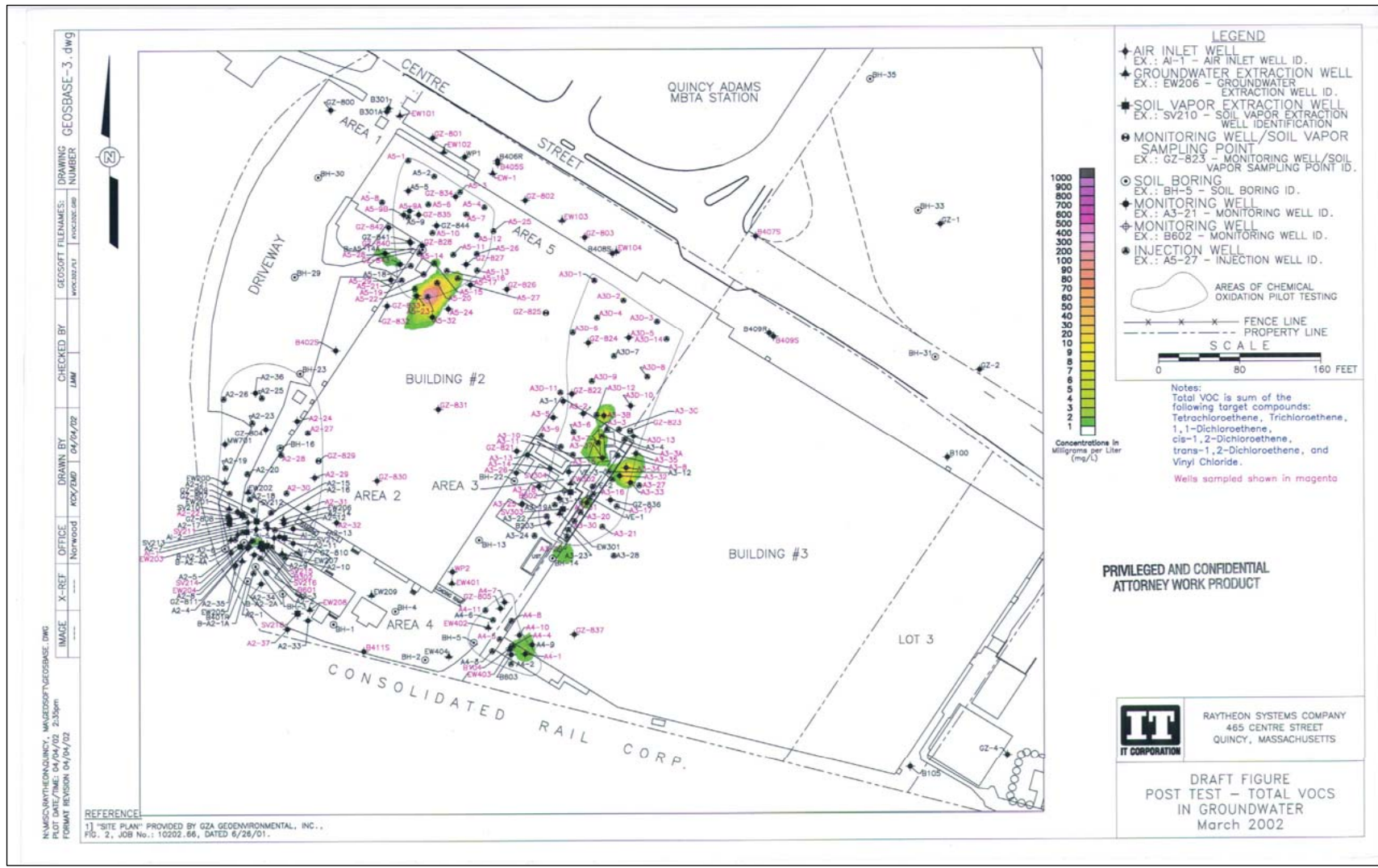

Post treatment (total VOCs >1 ppm)

**Site:** Union Chemical Company Superfund Site

**Contaminants:** TCE, DCE, DCA

**Oxidant:** Potassium permanganate

**Regulatory Agency Contact:** Mr. Terry Connelly (617) 918-1111  
US EPA Region 1

**Technology Contact:** Mr. Tim Pac (617) 646-7862  
Environmental Resources Management

## **Site Setting**

Site geology consists of low-permeability glacial till and fractured metamorphosed schist and gneiss, typical of glaciated New England ground moraine terrain. The soils present consist of up to 10 feet of fill/disturbed materials, overlying approximately 50 feet of hard (basal) till, above fractured schist and gneiss bedrock. The till is very compact, consisting of a silty matrix of heterogeneous clasts with discontinuous sand stringers. The depth to static water is variable, but generally 10–20 feet below grade. The average linear groundwater velocity is approximately 15 feet/year. Near the zone of contamination are private bedrock wells, but no nearby wells provide municipal water service in this rural setting. There is an adjacent small watershed stream. The stream is downgradient and is the discharge location for shallow groundwater. Deeper groundwater and bedrock flow patterns generally mimic stream flow.

## **Description of Target Treatment Zone**

Former operations at the site involved handling, storage, recycling, repackaging, and destruction of industrial solvents and other organic chemicals. The primary contaminants of concern were TCE, DCE isomers, and 1,1-DCA. Concentrations generally ranged 2–10 ppm, higher in hot spot areas. In 1979, the Maine Department of Environmental Protection (MEDEP) discovered that organic chemicals had impacted the groundwater. A 1981 site evaluation confirmed that solvents had contaminated the local aquifer. In 1984 operations were stopped by the MEDEP after more than 2,200 drums were found at the site. The treatment volume was approximately 1 acre of surficial expression.

## **Remedial Design**

ISCO was pilot-tested as a potential technique to accelerate the attainment of the groundwater standards by augmenting the pump-and-treat technology by providing a more aggressive, faster, and less expensive technology. In 1997, ISCO was unproven at field scale, and there were concerns with the potential selectivity of VOC destruction, desorption phenomenon, prediction of treatment effectiveness, dilution potential, and transport issues. There were also concerns regarding biological reductive dehalogenation including the impact of residual permanganate and the prediction of effectiveness. The goal of these pilot programs was to oxidize the contamination and then rapidly revert the site Eh from oxidizing to reducing conditions, more supportive of reductive dechlorination. A larger application of sodium lactate was conducted in 2002 to provide additional substrate to facilitate the biologic processes.

## Results

A series of annual permanganate applications was completed during the summers of 1998, 1999, and 2000, adding more than 43,000 pounds of oxidant into a 1.5-acre site and creating highly oxidizing conditions throughout the aquifer. This program was highly effective in the oxidation of readily mineralized compounds, particularly chlorinated ethenes (TCE and DCE isomers), ultimately facilitating the deactivation of the pump-and-treat component of the remedy. Post-ISCO monitoring revealed one to two orders of magnitude decrease in TCE and DCE, the most prevalent pretreatment COCs, whereas the concentrations of recalcitrant VOCs, particularly 1,1-DCA, were largely unaffected. At the close of 2000, ISCO activities were terminated, and a pilot application of carbon substrates was conducted using blackstrap molasses and sodium lactate.

The ISCO program demonstrated the destruction of the majority of the oxidizable compounds within the pilot area. The average destruction for all VOCs was 77%–87%. Remaining compounds were collocated with nonoxidizable compounds or present in several hot spot areas surrounding a single well. A potassium permanganate ( $\text{KMnO}_4$ ) bench test was performed using 20,000-mg/L solutions of spiked groundwater. The results of the bench test illustrated a >90% reduction in chlorinated ethenes, a 50% reduction in 1,1,1 TCA, and a 10%–15% reduction in hydrocarbons (toluene and xylenes). Based on this promising initial research, the completion of a field pilot application was recommended. A small field pilot test was performed during October 1997 by the gravity addition of 6,500 gallons of a 350-mg/L  $\text{KMnO}_4$  solution to one deactivated pumping well (providing a total oxidant dose of 20 pounds). The application well was surrounded by pumping wells to provide hydraulic capture and measurement locations after addition. Sampling of these wells after the application revealed slight decreases in metals (iron and manganese). VOC concentrations decreased 30% immediately after the test, exhibiting a slight rebound over time. The 1997 program confirmed that ISCO was nonviolent, exhibited only a limited area of impact, and the corresponding health and safety concerns were both moderate and manageable. No evidence of decreased well capacity by metals precipitation was observed. This test provided a demonstration to allay initial skepticism, sufficient to obtain regulatory acceptance with minimal performance expectations. An expanded field pilot test was conducted in 1998, when 48,000 gallons of 1%  $\text{KMnO}_4$  solution was added to 9 SVE and 11 pumping wells. These additions were completed using a low-pressure manifold. Hydraulic control was again maintained via continued operation of the remainder of the groundwater extraction system. Following the application:

- Significant reductions in total iron concentrations were observed while manganese concentrations did not show significant trends from baseline conditions.
- Additions into shallower SVE wells did not show immediate impacts as most of the addition was retained, or temporarily held, in the unsaturated soils located below the well above the surface of the water table. This permanganate slowly became available as it drained from the unsaturated soil matrix.
- Additions into pumping wells showed nearly immediate and significant impacts in adjacent monitoring wells.
- All additions were completed without adverse impacts to water bodies.

Estimated contaminant mass reductions of 30%–40% (~20 pounds VOC mass) were achieved over the three-month period. The result of the 1998 program reconfirmed the beneficial technical and economic potential of using ISCO technology on a larger scale.

Permanganate additions were further expanded in 1999 using a combination of SVE, pumping, and monitoring wells screened in both the overburden and the upper fractured bedrock aquifers. The goal in 1999 was to disperse permanganate across the site using operation of only three downgradient pumping wells to maintain hydraulic control. The additions proceeded from upgradient to downgradient to “sweep” toward the operating pumping wells. Over a four-month period, 156,000 gallons of 2% potassium permanganate (26,000 pounds) and 3,000 pounds of sodium permanganate were applied. Monitoring revealed the following:

- VOC concentrations in application wells decreased to virtually none detected.
- VOC concentrations in the pumping wells that remained in operation throughout the test continued to decrease in concentrations, presumably due to the reduction in source area and flushing.
- The most contaminated portions of the site, or areas where addition wells did not provide oxidant dispersal, were insufficiently dosed to oxidize the VOCs. These locations continued to show persistent measurable VOC concentrations.
- VOC concentrations in wells outside the treated area showed no oxidant impact.
- Analyses confirmed that the process decreased the chlorinated ethenes and nonchlorinated VOCs in both the bedrock and overburden aquifers.

During 2000, permanganate additions were surgically completed in target portions of the site (e.g., residual hot spot areas and proximate to a stream). Groundwater extraction was reactivated using only three pumping wells. Pumped groundwater was treated by a simplified treatment system and amended with  $\text{KMnO}_4$  for recharge (4,000 pounds). Small quantities of sodium permanganate (6,600 pounds) were applied to select locations and closely monitored for potential enhanced migration, preferential flow, and preventing impacts to shallow aquifer and/or surface water. As a result of the 2000 program:

- VOC concentrations in pumping and monitoring wells in the treatment area and vicinity continued to decrease;
- VOC concentrations for the chlorinated ethanes (e.g., 1,1-DCA) remained essentially unchanged, indicating nonreactivity to this oxidant and confirming recalcitrance to further oxidation;
- most of the readily oxidizable compounds were oxidized, leaving recalcitrant (i.e., nonoxidizable) compounds;
- limited amounts of oxidizable compounds remained, but only collocated with recalcitrant compounds—the application of additional chemical oxidant would be unable to remediate all the contaminants present, so additional chemical oxidation was deemed of little value; and
- application of alternative and/or stronger oxidants (e.g., Fenton’s, radical, hydrogen peroxide, ozone, persulfate) remained subject to delivery problems, regulatory approval, and concerns for surface water impact.

Based upon these observation and confirmation by the analytical sampling program, the bulk of residual VOC at the conclusion of the 2000 applications consisted predominantly of 1,1-DCA. 1,1-DCA went from being approximately the fourth most common VOC (1997) to the site VOC with the highest concentrations (2000). USEPA approved termination of further oxidative treatments, and correspondingly, termination of the pump-and-treat component.

As the ISCO programs continued, the concentrations of oxidizable constituents decreased, while the corresponding concentrations of *nonoxidizable* compounds (e.g., 1,1-DCA) remained stable. Extensive research was conducted into alternative technologies to address the remaining residual recalcitrant VOCs and continue the progress of remediation. Biological reductive dechlorination (BRD) by substrate addition was selected as the potentially most effective means to continue the progress of remediation. A specific work plan was developed to pilot a BRD approach, specifying substrates, site limitations, establishing well setbacks, BRD-specific monitoring criteria, and contingency precautions to address possible impacts to the stream. USEPA and MEDEP approved the completion of a BRD pilot application for 2001.

During the summer/fall of 2001, a small-scale BRD program was initiated by applying two substrates in different portions of the site. Applications consisted of 200 gallons of blackstrap molasses (four wells) and 23 gallons of 60% sodium lactate (three wells) in two pilot areas approximately 50 feet apart. Each substrate was diluted 1:10 to provide a larger hydraulic slug. The molasses applications were conducted in several wells under pressure to drive the substrate into the formation while the lactate applications were conducted using gravity only to minimize potential channelization. Post-application progress monitoring in the fall of 2001 and spring of 2002 recognized that these events might be too soon to illustrate significant changes. Data revealed the following:

- decreased ORP values (<150 mV at the site except in the one well that exhibited residual permanganate),
- depressed dissolved oxygen levels (<0.5 ppm in application wells),
- detection of trace nitrate and sulfate, suggestive that BRD was initializing/occurring, and
- varied concentrations of VOCs—wells exhibited slight decreases or increases with the majority of the wells showing no measurable impact.

Given the mixed performance, a second larger-scale pilot application was recommended for 2002. During August 2002, BRD applications were continued by applying 540 gallons of 60% sodium lactate. The lactate was applied after the well bore was purged of the standing column to minimize the effects of initial dilution and enhance the migration into the formation. Progress monitoring in the fall of 2002 and spring of 2003 revealed the following:

- decreased ORP values (<150 mV at the site except in the one well that continued to exhibit residual permanganate);
- continued depressed dissolved oxygen levels (<0.5 ppm in the application wells);
- continued detection of small concentrations nitrate and sulfate, suggestive that BRD was occurring/continuing; and

- varied VOCs—wells continued to exhibit slight decreases or increases, while none of the wells showed any measurable decline in 1,1-DCA.

The UCC site provides a unique window into the operations of ISCO and BRD. Widescale ISCO applications were conducted over four years. The applications were sequential, year over year, preventing the evaluation of any single addition. To adequately assess the impacts of the ISCO, these activities must be viewed holistically, considering the impacts to the site as a whole, not focusing on a single well or on a single remedial approach.

The BRD program was affected by similar limitations. Applications were conducted as single dosing events, applying excess substrate and relying on the site conditions for subsequent transport and delivery. Site conditions were not ideal (low permeability, low velocity, and “fingering”), which limited the potential effectiveness of both BRD and alternative strategies. The BRD applications in 2001 resulted in the following:

- Groundwater in the molasses area demonstrably transitioned from oxidizing (100 mV) to reducing (–100 mV), providing more conducive conditions to support natural anaerobic reductive dechlorination.
- Well headspace trace gas concentrations (particularly methane) and olfactory evidence increased, supporting the occurrence of BRD.
- VOC concentrations remained unchanged or exhibited a sitewide increase versus baseline.
- Sodium lactate areas showed no measurable impact to physical conditions or groundwater quality. Subsequent VOC results were consistent with those in the molasses areas. Since the sampling program occurred only 8–12 weeks post application, it is likely that this did not provide sufficient time for acclimatization and biomass lag time.
- It was determined that the pump-and-treat system, which was deactivated in October 2000, should remain off line.

The more widespread applications of BRD in 2002 resulted in the following:

- increases in chloroethane and vinyl chloride in several locations, suggesting some reductive dechlorination may be occurring;
- reducing conditions maintained; and
- no observable decreasing trend in 1,1-DCA concentrations.

Technology is ultimately controlled by the site conditions. In BRD, the virility of the bacterial population controls progress. Operation of the pump-and-treat component provided ample evidence of the presence of a bacterial population. Samples of the groundwater from two wells were collected in April of 2003 following the two years of BRD pilot testing. These samples were analyzed for the presence of nitrate- and sulfate-reducing, methanogens, and dechlorinating bacterial populations. While both samples exhibited the presence of dechlorination products (e.g., vinyl chloride, ethene, and ethane) and contained nitrate and sulfate reducers and methanogens, only one sample showed dechlorination of cis-DCE to vinyl chloride in 88 days. The second sample showed no evidence of dechlorination in the 95-day test period.



These analyses suggested that insufficient populations of bacteria for remediation were present. Recognizing that the total VOC concentration present in these areas is less than 3 ppm (typically 1 ppm), the bacterial populations are not robust and are highly stressed. In combination with the pilot program, this analysis confirms that BRD, even if successfully stimulated, would provide minimal impact over time. While the application of nonnative bacteria may provide an increase in bacterial capabilities, this approach has not been selected for this site due to regulatory concerns regarding the impacts to the adjacent surface water body.

ISCO operations left small quantities of unreacted oxidant in select areas of the site for several years. The application of BRD was designed to provide sufficient additional substrate to provide a quenching agent for residual permanganate and still provide available substrate to support BRD. BRD applications in wells containing residual permanganate and wells proximate to these locations eliminated the presence of the residual oxidant. Through chemical reaction, residual oxidant consumed a portion of the substrate and was overwhelmed by the additional substrate added. ORP values in the application wells changed from highly oxidizing to reducing in a single field season in wells that were located in the vicinity of the stream. These locations were in the former wetland areas where the substrate likely enhanced the natural return to a reducing environment.

As the BRD has not proven to be effective, USEPA and MEDEP have agreed to continue monitoring until subsurface conditions have equilibrated. Upon attainment of this condition, alternative approaches will be considered including technical impracticability. By aggressively attacking the groundwater contamination through ISCO, the contaminant levels have been sufficiently lowered to warrant a transition to a remedy that does not rely on active remediation for protection of human health and the environment. This could result in tremendous cost savings for long-term operating and maintenance and monitoring costs as the site is brought to closure as facilitated by the ISCO activities.

Site monitoring continues biennially and is anticipated to decrease as the site transitions to a long-term monitoring. The record of decision recognized that groundwater standards might not be attained after 15–30 years of active remediation. While the ISCO may have fallen short of ultimate closure, ISCO greatly reduced the active remediation to less than five years, facilitating a much earlier transition to long-term monitoring.

**Site Name:** Former Gasoline Station; New Castle, IN

**Contaminants:** BTEX, MTBE

**Oxidant:** Persulfate Activated by Fenton's Reagent

**Regulatory Contact:** Mr. Larry Studebaker; (317) 234-0991  
Indiana Department of Environmental Management

**Technology Contact:** Mr. Thomas Numbers (757) 220-6666

### Site Setting

Targeted treatment area is a portion of an industrial property in New Castle, Indiana, which had previously been used as a retail gasoline service station. The site was affected by historic petroleum spills from a leaking UST. Porosity was low (0.2), groundwater velocity was estimated at 0.03 feet/day in native glacial till soils. Depth to groundwater at the site ranged 8–15 feet below grade. A 4-foot smear zone existed because the aquifer is unconfined and fluctuates on a seasonal basis. The primary source of on-site contamination (leaking UST and visually contaminated soil) had recently been removed.

### Description of Treatment Volume

Contaminants of concern were volatile organic compounds, particularly BTEX and MTBE. Free product (LNAPL) was also found in one on-site monitoring well. The site covered approximately 2,550 square feet, and the contaminant thickness was approximately 7 feet (8-15 feet bgs), for an estimated treatment volume of 660 cubic yards.

### Remedial Design

Sodium persulfate injection was followed by a sequential application of iron activated hydrogen peroxide (Fenton's) was used to optimize the dispersion of chemical oxidant free radicals in tight soil conditions. The pretreatment step involved the injection of sodium persulfate solution through a customized direct-push horizontal jetting tool into the saturated zone at 2-foot vertical intervals in a series of boreholes across the impacted area.



In this way, a relatively short-lived oxidation process (Fenton's) was augmented by a relatively longer-termed oxidant (persulfate). The radius of influence was estimated at 10n feet. The temperature of the exothermic oxidation process was continuously monitored and controlled. Elevated temperatures not only encouraged the desorption of contaminants from the tight soil matrix but also activated the sodium persulfate previously impregnated in the soil matrix. Field personnel continuously monitored the effects of the reagent application in adjacent monitoring wells to evaluate and tightly control the performance of the technology at the site. All monitoring points in

the vicinity of the application were monitored for groundwater quality parameters, including dissolved oxygen, pH, specific conductance, temperature, oxidation/reduction potential, and static water level. The objective for the project was to treat the contaminants in the groundwater to Indiana Department of Environmental Management Risk-Integrated System Closure industrial standards.

## Results

The initial Fenton's treatment was applied in December 2003 for a period of two weeks using eight stationary injection wells. The results of this innovative sequential approach to treat in situ previously untreatable tight soils is very promising. Treatment goals were easily met and are presented below. There appeared to be continued contaminant reduction over a two-month period due to the use of bundled pretreatment and aggressive treatment technologies.

**BTEX and MTBE in injection wells reported in µg/L or parts per billion (ppb)**

<b>Boring ID</b>	<b>Sample date</b>	<b>Benzene</b>	<b>Toluene</b>	<b>Ethyl-benzene</b>	<b>Xylene</b>	<b>MTBE</b>
<b>RISC default closure levels for industrial groundwater</b>		<b>99</b>	<b>20,000</b>	<b>10,000</b>	<b>180,000</b>	<b>720</b>
AW-1	12/01/03	<5	<5	<b>5.8</b>	<b>20</b>	<5
	12/23/03	<b>26</b>	<b>19</b>	<5	<b>210</b>	<5
	02/20/04	<b>1.4</b>	<5	<5	<b>16</b>	<5
AW-2	12/01/03	<b>12</b>	<5	<b>6.4</b>	<b>17</b>	<5
	12/23/03	<5	<5	<5	<10	<5
	02/20/04	<1	<5	<5	<10	<4
AW-3	12/01/03	<b>5.4</b>	<b>16</b>	<b>66</b>	<b>76</b>	<5
	12/23/03	<5	<5	<5	<10	<5
	02/20/04	<1	<5	<5	<10	<4
AW-4	12/01/03	<5	<5	<5	<10	<5
	12/23/03	<5	<5	<5	<10	<5
AW-5	12/01/03	<5	<5	<5	<10	<5
	12/23/03	<5	<5	<5	<10	<5
AW-6	12/01/03	<b>67</b>	<b>290</b>	<b>33</b>	<b>220</b>	<5
	12/23/03	<b>12</b>	<b>40</b>	<5	<b>30</b>	<5
	02/20/04	<1	<5	<5	<10	<4
AW-7	12/01/03	<b>640</b>	<b>1,200</b>	<b>130</b>	<b>1,200</b>	<5
	12/23/03	<b>16</b>	<5	<5	<10	<5
	02/20/04	<b>5</b>	<5	<5	<10	<4
AW-8	12/01/03	<b>700</b>	<b>6</b>	<5	<b>16</b>	<5
	12/23/03	<b>220</b>	<b>42</b>	<b>81</b>	<b>100</b>	<5
	02/20/04	<b>40</b>	<5	<5	<b>15</b>	<4

**BOLD** indicates concentration exceeds the laboratory detection limit.

**BOLD/SHADED** indicates concentration exceeding RISC default closure levels for industrial standards.

Samples were analyzed using USEPA SW-846 Method 8260.

**Site:** Pierce Service Station, Los Angeles, CA

**Contaminant:** BTEX

**Oxidant:** Fenton's Reagent

**Regulatory Agency Contact:** Ms. Mercedes Hsu (213) 576-6600  
Los Angeles Regional Water Quality Control Board

**Consultant:** Mr. Gary Cronk (949) 222-9133  
MECX, LLC

## **Site Setting**

An off-site gasoline plume extended approximately 150 feet to the southwest of the former Pierce Service Station site, across two high traffic streets. Groundwater flows towards the southwest at a mild gradient of 0.008 feet/foot. The groundwater velocity is estimated to be 0.04 feet/day. The Los Angeles Regional Water Quality Control Board (LARWQCB) considers the shallow aquifer a potential drinking water source. A high school campus (a sensitive receptor) is located directly downgradient of the site. Baseline iron levels in the groundwater ranged 6–338 mg/L, and total organic carbon 17–35 mg/L. The aquifer sediments comprise silty sands in the uppermost portion of the aquifer and low-permeability clayey silts in the lowermost.

## **Description of Target Treatment Volume**

The COCs at this site included BTEX as well as TPH as gasoline (TPHg). No MTBE was identified. The plume was confined to a shallow alluvial aquifer at a depth of 30–45 feet bgs. The approximate areal extent of the targeted contamination was 7,065 square feet, and the aquifer volume was estimated at 5,200 cubic yards. The highest pretreatment level of benzene (risk driver) was 2,000 µg/L, and the highest TPHg was 65,000 µg/L.

## **Remedial Design**

Design of the field injection parameters was evaluated from a proprietary model that incorporates geochemical and hydrogeologic parameters for the site and determines the appropriate quantities of oxidant required. Specific values of NOD, SOD, or NOM are not evaluated by this model but are indirectly accounted for in the model output. Twenty-one injection wells (screened 31–46 feet bgs) were installed and used during a full-scale treatment of the site using the Fenton's oxidation remediation technology. Based on prior experience with low-permeability soils, the injection wells were estimated to have an ROI of about 15 feet. The ROI estimate was confirmed in the field by measuring changes in water quality parameters. The wells were spaced approximately 25 feet apart and staggered to provide overlapping treatment radii and cover the off-site plume. The groundwater was initially "conditioned" by injection of a small quantity (50 gallons/well) of a catalyst solution consisting of ferrous sulfate and hydrochloric acid. Hydrogen peroxide (17.5% solution) was then gravity-fed into the subsurface (not pumped or pressurized). Down-hole temperatures were monitored during the injections, and the rate of injection of peroxide was controlled to ensure the groundwater temperatures did not exceed 180°F. Over the course of four-weeks, a total of 8,600 gallons of hydrogen peroxide was injected in the groundwater. The average injection quantity was 430 gallons/well.

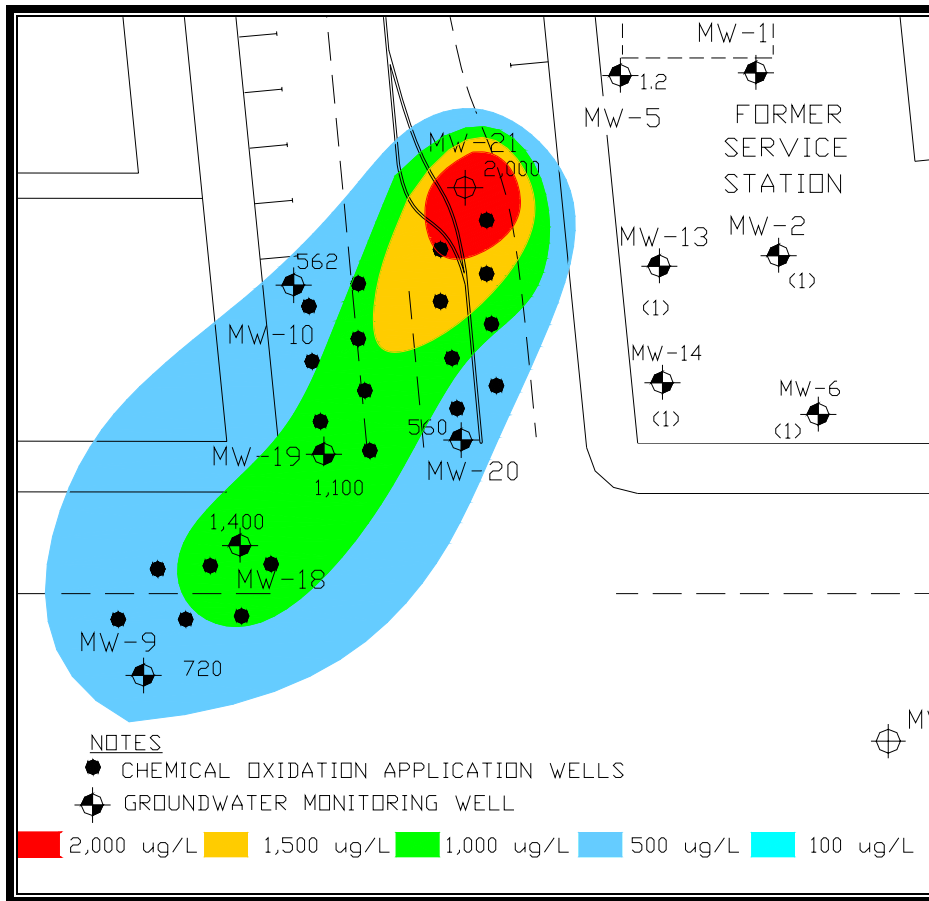

**Figure 1. Benzene isoconcentration map from May 2003 (baseline conditions).**

## Results

Overall, the Fenton's oxidation remediation technology was highly successful at this site. Following treatment, the benzene level in the most contaminated well was reduced from 2,000 to 240 µg/L (88% reduction), and TPHg was reduced from 62,000 to 4,300 µg/L (93% reduction). Overall, the six monitoring wells showed an average 96% reduction in benzene and 93% reduction in TPHg. The following table summarizes the reductions in TPHg and benzene levels at the six monitoring wells at the site.

Several wells nearest the source area indicated no reductions or slight increases in contaminant levels following the first three months of monitoring (August 2003). However, after four to six months of groundwater monitoring (January 2004), the benzene concentrations in all the wells were reduced significantly (average 78% reduction). After one year following treatment, the benzene levels were reduced an average of 96%. The delayed treatment effect is believed to be due to the slow reequilibration of sorbed and dissolved phases in the subsurface following to the vigorous Fenton's reaction. It is also probable that a biostimulation effect occurred from increased levels of dissolved oxygen released by the hydrogen peroxide. The biostimulation effect may continue to occur at this site for several more months, and benzene levels will likely continue to drop. Indoor air quality was not evaluated at this site.

Sample date	TPH gas (µg/L)	Percent reduction	Benzene (µg/L)	Percent reduction
<b>MW-9</b>				
5/21/2003	2,600		720	
8/1/2003	990	62	150	79
1/9/2004	520	80	250	65
6/25/2004	180	93	3.3	100
<b>MW-10</b>				
5/21/2003	17,000		562	
8/1/2003	2,800	84	77	86
1/9/2004	3,100	82	110	80
6/25/2004	1,600	91	21	96
<b>MW-18</b>				
5/21/2003	55,000		1,400	
8/1/2003	61,000	-11	1,300	7
1/9/2004	16,000	71	180	87
6/25/2004	4,000	93	25	98
<b>MW-19</b>				
5/21/2003	66,000		1,100	
8/1/2003	15,000	77	660	40
1/9/2004	7,800	88	240	78
6/25/2004	4,100	94	17	98
<b>MW-20</b>				
5/21/2003	38,000		560	
8/1/2003	7,700	80	490	13
1/9/2004	7,200	81	91	84
6/25/2004	2,100	94	37	93
<b>MW-21</b>				
5/21/2003	62,000		2,000	
8/1/2003	29,000	53	1,700	15
1/9/2004	10,000	84	540	73
6/25/2004	4,300	93	240	88

No site-specific cleanup goals have been established for this site. Considering the elimination of the contaminant source area and the long-term effects of biostimulation and natural attenuation on the remaining low levels of benzene, this site qualifies for closure. Final closure of the site is currently being sought from the LARWQCB.

### Cost

The total cost to complete the Fenton's treatment was approximately \$360,000, or \$69 per cubic yard (by volume). The total estimated quantity of hydrocarbons destroyed by the Fenton's treatment was 10,600 pounds at a cost of \$34 per pound removed. This calculation was based on a measured

93% reduction in TPHg applied to a baseline measured adsorbed mass of 11,400 pounds. This project is considered successful because of the mass reduction and the decrease in risk to human health and the environment.

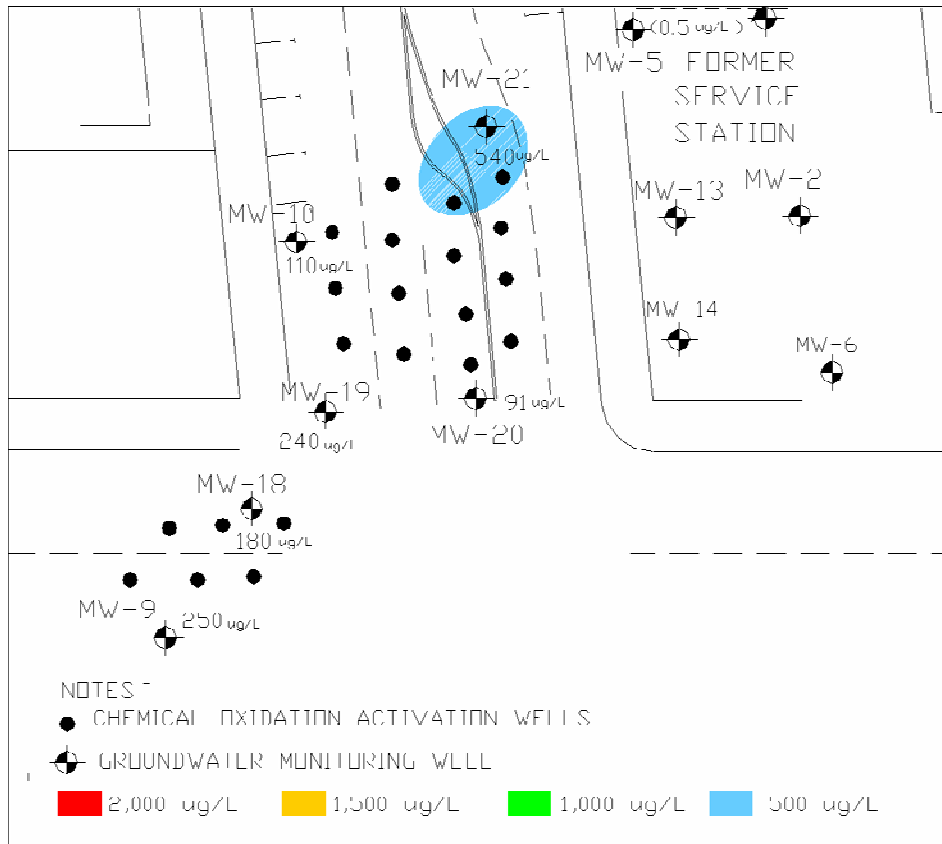

**Figure 2. Benzene isoconcentration map from January 2004 (six months after Fenton's treatment).**

**Site:** Retail Fueling Facility; Westport, MA

**Contaminant:** BTEX and MTBE

**Oxidant:** Hydrogen Peroxide, with biological catalysts

**Regulatory Agency Contact:** Ms. Molly Cote (508) 946-2700  
Massachusetts Dept. of Environmental Protection, Southeast

**Technology Contact:** Mr. Lawrence Lessard (877) 882-3352  
Lessard Environmental

## Site Setting

This 5-acre property contains an active retail gasoline filling station and convenience store on the southern half of the parcel; the northern half remains an undeveloped, wooded, and sensitive (protected) wetlands area. The site is located in a mixed commercial and residential area. Records indicate the site has been a retail gasoline filling station since 1957. Soil lithology on the developed portion of property consists of fill material, fine to coarse sand with trace gravel, and till, with bedrock encountered at 35–50 feet bgs. Soil lithologies on the undeveloped northern half of the parcel were similar except within the 0–5-foot layer that consists of till with a medium to coarse sand matrix. Bedrock investigations revealed massive bedrock with the absence of significant fractures. Groundwater at the site fluctuates from approximately 5–15 feet bgs depending on the well location and time of year. Groundwater flows generally to the north and northeast across the site. The hydraulic gradient at the site was calculated to range 0.0023–0.021 feet/foot. The hydraulic conductivity of the overburden aquifer was determined to be 4.54 feet/day, and the average transmissivity was calculated at 113.5 square feet/day.

## Description of Target Treatment Volume

The site and areas downgradient have been affected by historical releases of gasoline from the UST system and/or from overfilling of the system. The contaminants of concern include BTEX, MTBE, and the various carbon fractions per Massachusetts volatile petroleum hydrocarbon (VPH) analysis requirements. Prior remedial actions included the removal of approximately 900 cubic yards of soil in 1999 during station upgrade activities. Soil impact was estimated to range from depths of 4–20 feet bgs across a horizontal area estimated to be 25,000 square feet for an approximate treatment volume of 15,000 yd<sup>3</sup>. Based on an estimated average soil impact of 640 mg/kg, the contaminant mass was approximately 15,000 kg. The average groundwater concentrations within the source area were as follows:

BTEX	=	20,200 ppb
MTBE	=	1,800 ppb
Total VPH	=	10,100 ppb

## Remedial Design

The remediation objective was to aggressively treat the source area and adjacent groundwater while enhancing the natural attenuation of residual contaminants within the downgradient plume. The approach involved the sequential pulsed injections of hydrogen peroxide and biological catalysts, identified as the Bio-Rem<sup>OX SM</sup>, or generically, as the biologically enhanced chemical oxidation



(BECO) process. This approach was selected as a nonintrusive means for treating the source area with consideration for the adjacent sensitive wetland area. At this site the downgradient radius of influence was estimated to be approximately 25–30 feet. Due to the size of this plume, most remedial activities were focused within the source area and up to about 250 feet downgradient of the source area.

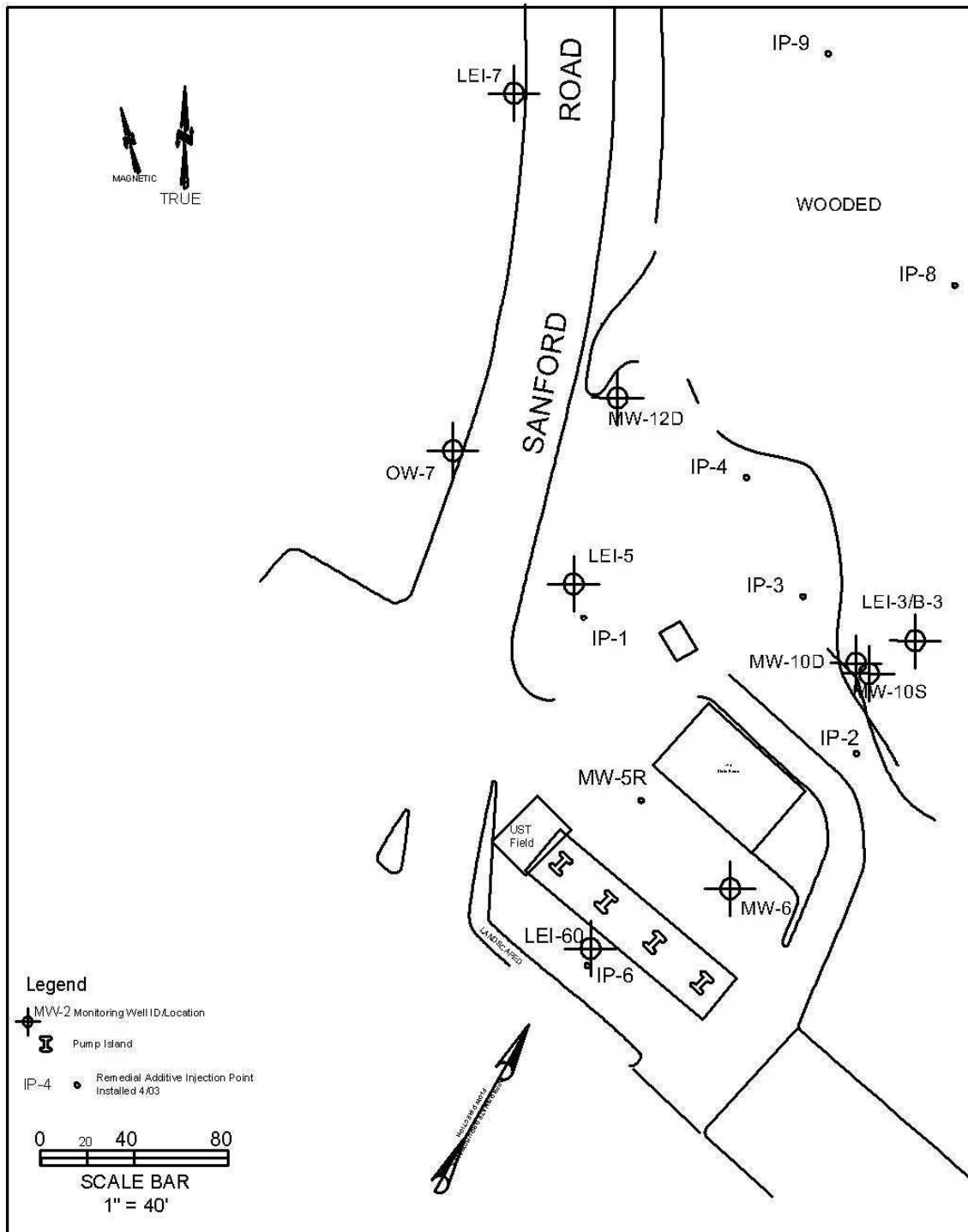

Site map.

A total of nine vertical injection points was installed to supplement the existing groundwater monitoring well network. To date, each of these new injection points and six of the monitoring wells have been used for oxidant injection, with a subset used for biological injections. Three complete BECO injection events occurred over a six-month period from June to November 2003. For safety and control purposes, all oxidant was gravity-fed to the injection points via a self-contained mobile injection unit containing 50% hydrogen peroxide. The actual percentage of peroxide is diluted in real time via a control manifold to optimize the effectiveness of each oxidant injection event. Oxidant injections were performed on June 9–10, August 19–20, and November 12–13 with the biological application following within 14 days of each oxidant injection.

Subsurface vapor monitoring was conducted during each oxidant injection event at each injection point. Monitoring at the injection wells included temperature, total organic vapors, oxygen, and lower explosive limit. Vapors for these same parameters were monitored in subsurface utility conduits and other potential vapor migration pathways in the vicinity of the injection areas. Ambient air is also measured at building structures proximal to the treatment zone.

## Results

Groundwater samples collected from eight key well points indicate that volatile petroleum hydrocarbon levels have been reduced by 85%–98% at six of the sampling points, while two have shown reductions of 23%–45%. Similarly, MTBE levels have decreased by 88%–100% at five sampling points and 45%–65% at the other three locations. Heterotrophic plate counts (HPC) were monitored before, during, and after the six-month treatment period, as a qualitative method of identifying the potential presence of bacteria that may contribute to the natural attenuation of residual contaminants. Initially, all but one sampling point exhibited HPC levels of less than 500 colony-forming units per milliliter (CFU/mL). After treatment, HPC counts increased in all wells sampled within the treatment zone between 100,000 and >1,000,000 CFU/mL. Analytical results for contaminant concentrations and HPC levels for key well points are provided in Tables 1 and 2.

## Cost

Injection wells	\$10,000
3 BECO injection events	<u>24,000</u>
Total remedial costs	\$34,000

**Table 1. Contaminant analysis (in ppb [ $\mu\text{g/L}$ ])**

Well	Analyte	2/20/2003	5/28/2003	9/3/2003	12/11/2003	Reduction
LEI-5	VPH	1,800	3,170	1,103	204	89%
	MTBE	300	78	88	37	88%
Well MW-5R	VPH		2,245	9/3/2003 125	12/11/2003 125	94%
	MTBE		5,200	2	26	100%
Well LEI-60	VPH		10,010	9/3/2003 10,254	12/11/2003 1,549	85%
	MTBE		12	52	1	96%
Well MW-10D	VPH		3,225	9/3/2003 676	12/11/2003 1,768	45%
	MTBE		4,800	2,590	2,640	45%
Well OW-7	VPH	2/20/2003 6,710	5/28/2003 8,063	9/3/2003 1,250	12/11/2003 4,560	32%
	MTBE	120	120	28	59	51%
Well MW-6	VPH	2/20/2003 7225	5/28/2003 5,350		12/11/2003 179	98%
	MTBE	1,200	350		3	100%
Well MW-10S	VPH	2/20/2003 3,425	5/28/2003 4,100	9/3/2003 1,191	12/11/2003 238	93%
	MTBE	10,500	21,600	3,010	3,640	65%
Well MW-12D	VPH	2/20/2003 3,425	5/28/2003 275	9/3/2003 63	12/11/2003 63	98%
	MTBE	2,000	1,900	3	9	100%

**Table 2. Heterotrophic plate counts (HPC), in CFU/mL**

Well MW-5R	6/6/2003 470	6/24/2003 0	9/3/2003 170,000	12/11/2003 5,400,000	
Well LEI-5	6/6/2003 120	6/24/2003 32,000	8/20/2003 130,000	9/3/2003 200,000	12/11/2003 1,300,000
Well LEI-7	6/6/2003 150	6/24/2003 36,000	8/20/2003 580,000	9/3/2003 96,000	
Well LEI-3	6/6/2003 99	6/24/2003 36,000	8/20/2003 300,000	9/3/2003 210,000	12/11/2003 11,500
Well LEI-30D	6/6/2003 470	6/24/2003 5	8/20/2003 720	9/3/2003 34,000,000	12/11/2003 400,000
Well LEI-60	6/24/2003 44,000	8/19/2003 3,000	9/3/2003 19,000	12/11/2003 430,000	
Well LEI-31D	6/6/2003 415	6/24/2003 32,000	8/20/2003 190,000	9/3/2003 15,000,000	

**Site:** Residential Fuel Oil Release, Connecticut

**Contaminant:** TPH Fuel Oil

**Oxidant:** Hydrogen Peroxide

**Regulatory Agency Contact:** Connecticut Department of Environmental Protection

**Technology Contact:** Mr. Lawrence Lessard (877) 882-3352

Lessard Environmental

### Site Setting

Two to three hundred gallons of heating oil was released from an aboveground storage tank line feeding an oil burner. The leaking feeder line was located beneath the basement of this single-family residential home. Initial response actions taken by the tank removal contractor included the removal of the concrete floor from all accessible areas of the basement and the excavation and disposal of affected soils. Soil conditions at the site were characterized as densely packed fine to medium sands with numerous cobbles. Groundwater at the site fluctuated around the level of the basement floor requiring a sump pump to avoid flooding during periods of elevated groundwater. Accordingly, the excavation was consistently infiltrated with fuel oil-affected groundwater. Initially, the contaminated water within the excavation was pumped into a fractionation tank for holding prior to evacuation and disposal via a vacuum truck. Over 40,000 gallons of fuel oil impacted water was removed from the site for off-site disposal. The process was later converted by the tank removal contractor to process the water from the fractionation tank through a carbon filtration system prior to discharge to the municipal sewer system. Due to the excessive cost of these options, Lessard Environmental was contacted and asked to provide an alternative using injection-based remediation.

### Pre-ISCO Excavation Soil Conditions (March 2000)

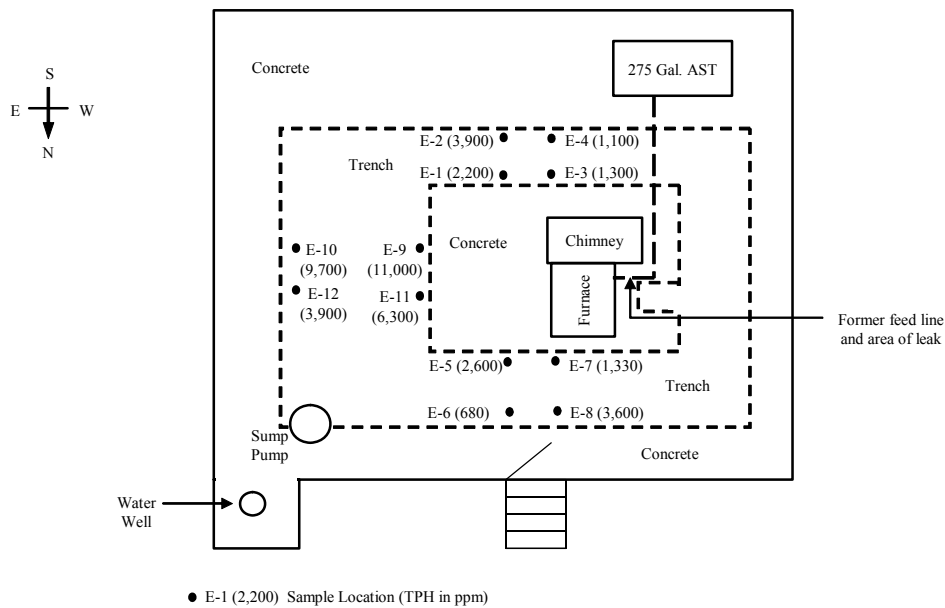

Four soil borings completed as monitoring wells were installed by the tank removal contractor around the perimeter of the home. These locations did not exhibit any impact to soil or groundwater, indicating that impact was limited to the footprint of the building structure. Fuel oil constituents as measured by TPH analysis were detected in soil above applicable standards of 500 ppm at various points along the excavation side walls up to a peak of 11,000 ppm with an average concentration of 3,000–4,000 ppm. TPH was detected at 8,300 ppb in perched groundwater within the excavation exceeding Connecticut residential standards of 1 ppb. A drinking water supply well located 7 feet from the boundary of the excavation and believed to be set at a depth of about 75 feet was periodically tested and found to be unaffected by the fuel oil release. Groundwater requiring treatment was limited to that exposed by the basement excavation as well as that which was within the zone of influence of the sump pump.

## **Remedial Design**

Excavation activities were terminated approximately 30 inches from the perimeter interior concrete foundation walls. The objective for completion of this project was to reduce remaining fuel oil impact to soil without having to excavate any further. Additional excavation would require both hydraulic control (due to the high groundwater table) and possibly the supporting of the building foundation to remove affected soil beneath the foundation structure. Such intrusive measures can be quite costly and can lead to structural damage while undermining the building or at a later date due to settling. In addition, impacted groundwater within and proximal to the excavation would need to be reduced to meet applicable TPH standards.

ISCO with hydrogen peroxide as the oxidant was selected due to its less invasive nature, coupled with prior firm experience in successfully treating similar substructure contaminant impacts. Written approval from the CT DEP for ISCO treatment was received in May 2000.

Prior to the application of the hydrogen peroxide, eleven core holes were advanced through sections of the remaining concrete floor around the perimeter of the excavation. These points were used to inject the oxidant to treat beyond and within the excavation sidewalls. After the second injection event, soil samples were collected from the excavation sidewalls and base to assess the effectiveness of the program. A lack of TPH reduction prompted a modification of the injection gallery to include a liquid impermeable barrier along the excavation sidewalls to enhance the contact time of the oxidant with impacted soil. The modified injection gallery was used to perform the remaining four ISCO injection events required for this project. All oxidant injections were gravity fed for safety and control reasons and consisted of up to 35% hydrogen peroxide. Based on field monitoring results, ISCO-experienced and -trained personnel custom-diluted the oxidant to optimize the effectiveness of each injection event. During each injection event, site conditions such as ambient air and injection point temperature were monitored for safety purposes.

## **Results**

A total of six injection events were conducted over a 90-day period from May to August 2000. A total of 1,100 gallons of 35% hydrogen peroxide was injected during the project. Fuel oil impact to groundwater infiltration within the excavation was reduced 100%. Initial results of 8,300 ppb TPH detected in the March 2000 were reduced to nondetectable levels when the sump pump discharge

was sampled in April 2001, six months after ISCO treatment was completed. Initial soil samples taken from excavation sidewalls exhibited average concentrations of extractible TPH of 3,968 ppm (Table 1). Soil samples taken after the fifth ISCO event indicated that all areas except two had been reduced near or below the 500 ppm Connecticut standard. A sixth and final injection event focused on the two remaining hot spots. Post-injection sampling revealed that these areas remained above standards.

### Post-ISCO Excavation Soil Conditions (August 2000)

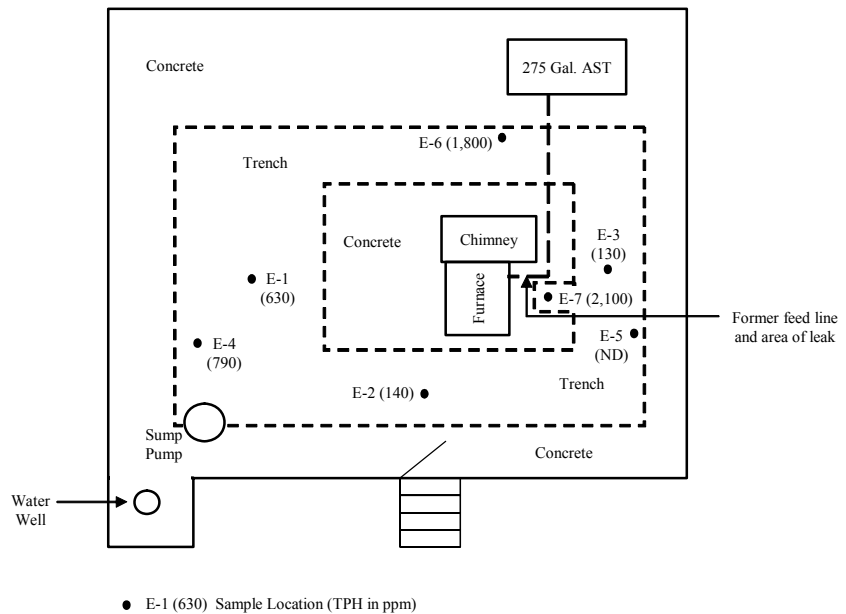

The post-remedial average TPH levels within the excavation had been reduced to 799 ppm (Table 2). While this represented an 80% reduction in TPH levels within the excavation area, it remained above the 500 ppm Connecticut standard.

The excavation area however was not considered to be representative of general soil conditions at the property. Consequently, a risk characterization technique was employed by averaging the TPH levels of soils from within the excavation zone with those taken during installation of the four exterior borings. Ordinarily, new soil borings would have been advanced to confirm that soil conditions outside the perimeter of the building foundation remained unaffected. However, in this case the preredial soil results were permitted to represent post-remedial conditions. The justification for this approach was that both the soil and groundwater at the perimeter borings did not reveal any fuel oil impact when first installed. Considering groundwater flow data and that subsequent groundwater analysis continued to reveal no effect at these perimeter wells (the last sampling round was conducted in October 2001, more than one year after the last oxidation event), it was considered reasonable to assume that the soil conditions had also remained unaffected. This approach indicated that average soil conditions at the property were below standards as they exhibited TPH levels of 481 ppm (Table 3). Based on these results, a site closure report was submitted to CT DEP in December 2001. In January 2002 a letter was issued by CT DEP stating that the carbon filtration system for the basement sump pump was no longer required.

**Table 1. Pre-ISCO excavation soil conditions**

Sample depth	Sample designation	TPH concentration
24"	E-1	2,200
	E-2	3,900
36"	E-3	1,300
	E-4	1,100
24"	E-5	2,600
	E-6	680
36"	E-7	1,330
	E-8	3,600
24"	E-9	11,000
	E-10	9,700
36"	E-11	6,300
	E-12	3,900
<b>Average</b>		<b>3,968</b>

Results reported in ppm (mg/L).

**Remedial Costs**

Injection gallery	\$5,000
Six injection events	30,000
Barrier installation	<u>20,000</u>
Total remedial costs	\$55,000

**Table 2. Post-ISCO excavation soil conditions**

Sample designation	TPH concentration
E-1	630
E-2	140
E-3	130
E-4	790
E-5	5
E-6	1,800
E-7	2,100
<b>Average</b>	<b>799</b>

Results reported in ppm (mg/L).

**Table 3. Post-ISCO site representative soil conditions**

Sample designation	TPH concentration
E-1	630
E-2	140
E-3	130
E-4	790
E-5	5
E-6	1,800
E-7	2,100
B-1	5
B-2	5
B-3	5
B-4	94
B-5	78
<b>Average</b>	<b>482</b>

Results reported in ppm (mg/L).

**Site:** Active Retail Gasoline Station; Kenton, Delaware

**Contaminant:** BTEX, MTBE, TAME, TBA

**Oxidant:** Ozone–hydrogen peroxide

**Regulatory Agency Contact:** Mr. William Fischer (302) 395-2500  
Delaware Department of Natural Resources

**Technology Contact:** Charles B. Whisman, P.E. (800) 426-9871 ext 156  
Groundwater Environmental Services

## Site Setting

The site operated as a retail gasoline station since 1970, and a petroleum leak was discovered during the removal of a 6,000-gallon unleaded gasoline UST on July 17, 2000. Shallow soils at the site and surrounding properties consist of yellow to dark brown, medium, well-graded sand with some clayey sand. Gray clay exists beneath the sand, from approximately 32–44 feet bgs. Gray sand with shell fragments is encountered below the clay extending approximately 45–85 feet bgs. At 85 feet bgs, a lean, brown clay is encountered, which is logged to be greater than 15 feet thick. Bedrock was not encountered during drilling activities. Groundwater is typically encountered at depths ranging 8–16 feet bgs under unconfined conditions.

## Description of Target Treatment Volume

The site contained significant adsorbed-phase and dissolved-phase BTEX. Other contaminants included MTBE, TAME, and TBA. The aerial extent of the groundwater plume was approximately 160,000 square feet, and the affected aquifer volume was estimated at 120,000 cubic yards (6–22 feet bgs). A total of eight nearby residential water supply wells were affected by the contaminants, and two on-site monitoring wells contained LNAPL. Preremediation dissolved concentrations throughout the 800-foot-long plume were observed at concentrations up to 26,300 µg/L for BTEX; 26,500 µg/L for MTBE; and 27,000 µg/L for TBA. Preremediation DO concentrations in the dissolved-phase plume were 0.5–1.0 mg/L.

## Remedial Design

Following site characterization activities, ISCO was chosen as the remedial solution for the subject property mainly because it had the lowest life-cycle remediation cost. The remediation goals included the removal of LNAPL and the reduction of sorbed and dissolved-phase contaminant concentrations to below Delaware Department of Natural Resources and Environmental Control (DNREC) cleanup levels. The groundwater cleanup goals included reducing benzene concentrations to <29 µg/L, MTBE concentrations to <180 µg/L, and TBA concentrations to <120 µg/L.

A chemical oxidation trailer, used continuously for a period of up to nine months, cycled oxidant injections to 10 nested wells and 16 additional well points. A vapor recovery system was used to prevent the accumulation of vapors (including ozone) in the vadose zone and to help remediate some of the unsaturated adsorbed-phase mass in the vicinity of the existing UST system. The aggressive chemical oxidation process used small-diameter (1/2-inch) nested stainless steel injection points. Each of the injection locations contains two nested injection points: ozone, oxygen, and compressed air are injected into one injection point, and hydrogen peroxide is injected into the second injection



point. This chemical oxidation process uses three powerful oxidizers together—ozone, hydrogen peroxide, and hydroxyl radicals to aggressively break down organic compounds.

The chemical oxidation system used at this site consisted of five processes: chemical oxidation via ozone injection, chemical oxidation via hydrogen peroxide injection, chemical oxidation via hydroxyl radical reactions, enhanced bioremediation via high dissolved oxygen levels, and mass transfer of VOCs via air injection. The system was designed to aggressively distribute the reactants into saturated soils and groundwater so that the radius of influences are more than 15–20 feet surrounding each injection well.

The enhanced distribution of the oxidants in the subsurface soil and groundwater was achieved by using nested injection wells to distribute ozone (20–24 feet bgs), hydrogen peroxide (14–16 feet bgs), oxygen, and air into saturated soils and groundwater and achieve a large ROI, by delivering high flow rates of ozone, oxygen, and air at up to 17 scfm. In addition, the injection of ozone, oxygen, and air helps mix and distribute hydrogen peroxide to increase the ROI of hydroxyl radical production and using low-flow-rate ozone injection at approximately 1–2 scfm, typically pulsed, ensures high concentrations of ozone of up to 100,000 ppm for rapid contaminant breakdown. A system control panel was used that varies the combination of reactants, cycling durations, injection locations, and injection flow rates via a programmable logic controller to simplify the implementation of this technology.

## **Results**

The gas flow rate of the ozone, oxygen, and compressed air stream was able to create an ROI of >15 feet at each injection location, thereby remediating LNAPL as well as sorbed-phase and dissolved-phase contaminants in the surrounding saturated soils. After seven months of treatment, DNREC granted approval to deactivate the remediation systems and initiate one year of groundwater monitoring for closure. After seven months of post-remediation monitoring, only one well, located in the source area, indicated dissolved MTBE concentrations above 30 µg/L. BTEX, MTBE, and TBA were not detected (<4 µg/L) in the other sampling locations.

DO concentrations increased significantly across the source area. During system operation, injection well DO levels were as high as 25 mg/L. The entire area of impact indicated elevated DO concentrations (>5 mg/L throughout the entire 800-foot-long affected area, even though injection wells were installed only in the upgradient half of the plume. Dissolved carbon dioxide was measured at nearby observation wells, indicating that the expected reactions were occurring as contaminants broke down chemically. Vadose zone headspace measurements indicated elevated levels of carbon dioxide, oxygen, and ozone at nearby observation wells, indicating that unsaturated soil contaminants were likely being remediated in addition to saturated soil contaminants.

## **Costs**

Capital costs for the installation of the remediation system were approximately \$95,000 (including trenching, subsurface piping, installation of the 10 injection points, and resurfacing to the injection points located on multiple properties). Operation and maintenance costs averaged \$15,000 per month

(including all materials, hydrogen peroxide, electrical utilities, labor, and reporting). The total cost to remediate the entire dissolved-phase plume was less than \$200,000.

## Detected Presence of Contaminants

**Pre-remediation**

**After 5 months of remediation**

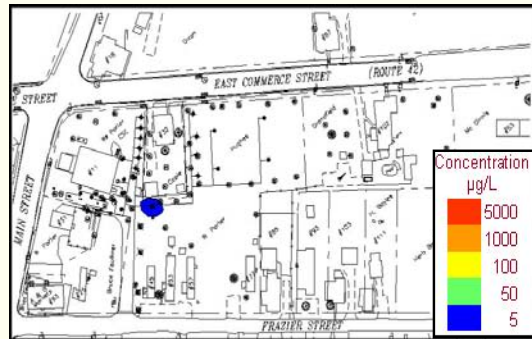
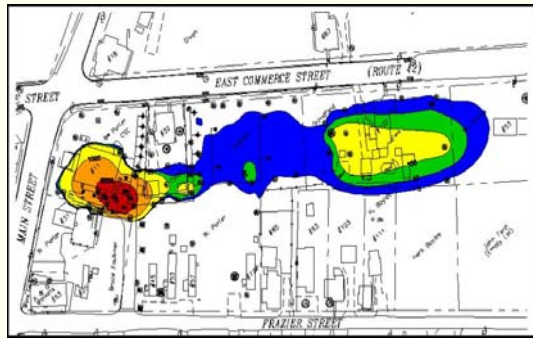

**BTEX**

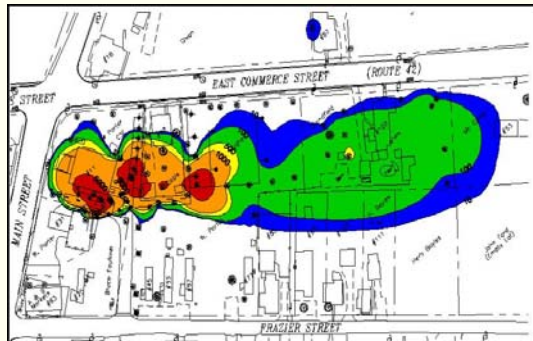
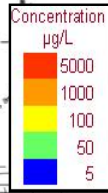

**MTBE**

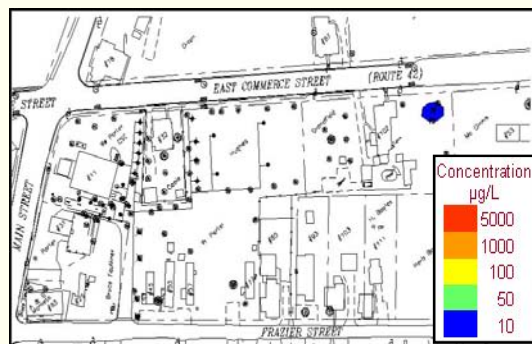
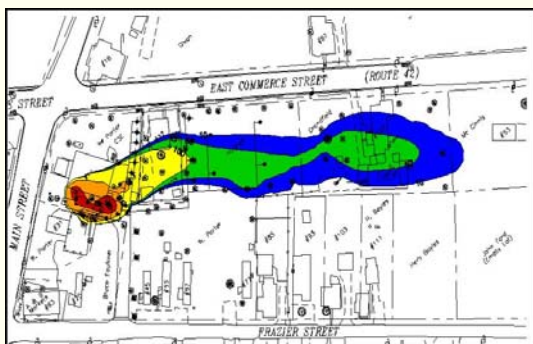
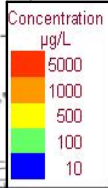

**TBA**

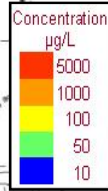

**Site:** Former Service Station Site; Southeastern PA

**Contaminant:** BTEX, MTBE, PAH (naphthalene)

**Oxidant:** Ozone

**Regulatory Agency Contact:** Laurel Mapleton (610) 832-5949  
Pennsylvania Department of Environmental Protection (PADEP)

**Technology Contact:** Mr. Scott Miller (856) 273-1009  
Resource Control Corporation

### Site Setting

This project involved an out-of-service, former retail petroleum service property that was undergoing a real estate transaction. Environmental assessment activities had been completed, following a UST removal event. The site lithology is mainly silty sand and fill material. Depth to groundwater is generally at 10–12 feet bgs. Among the potential receptors was a large pet store next to the site. Prior to using ozone gas injection, a groundwater pump-and-treat system was used to prevent migration of dissolved contaminants, and to reduce contaminant levels.

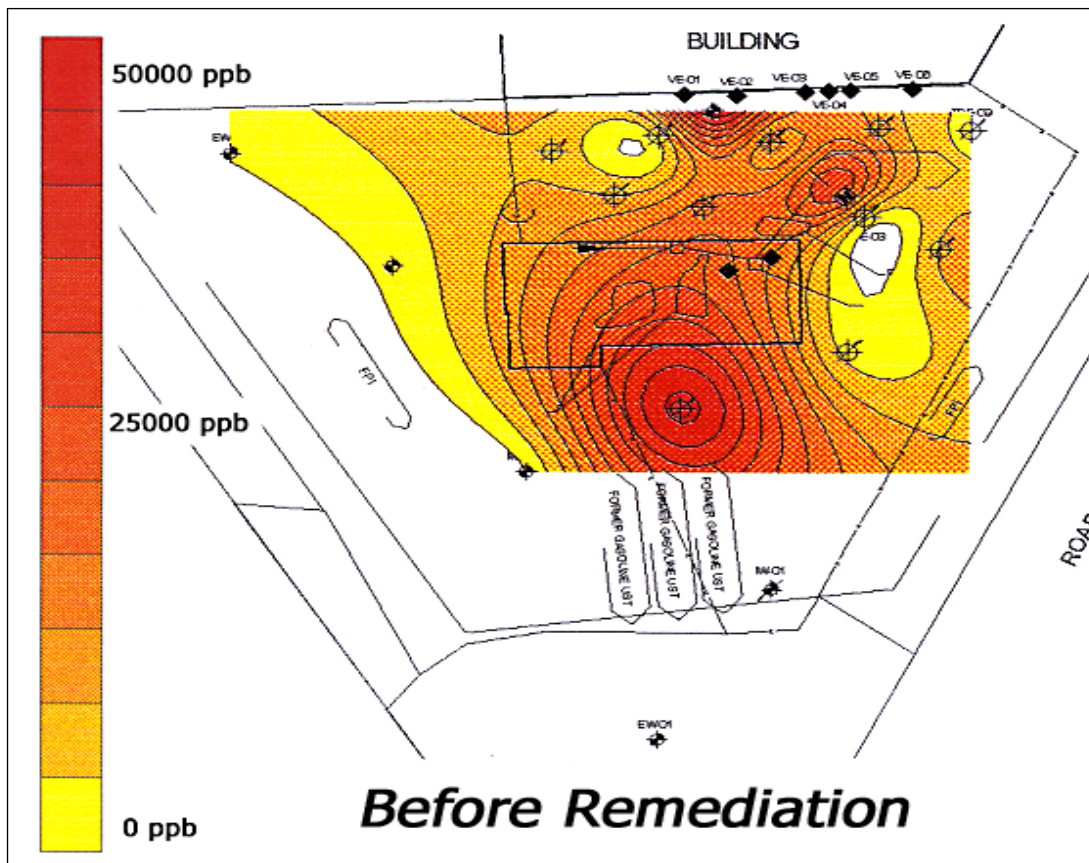

### Description of Target Treatment Volume

Observations during the tank removal activities revealed the presence of LNAPL on the water table beneath the site and high residual concentrations of petroleum hydrocarbons in soil and

groundwater. Targeted compounds exceeding the PADEP cleanup standards included BTEX, naphthalene, and MTBE.

### **Remedial Design**

The remedial goal for the site was to remove all LNAPL from the subsurface and reduce adsorbed and dissolved-phase hydrocarbons to levels that would allow natural attenuation of the remaining contaminants as a viable long-term approach to site cleanup. The nine-month timeline for cleanup was the driving factor for site remediation. In situ oxidation via ozone gas was selected to aggressively remove LNAPL, reduce soil concentrations to an acceptable risk level, and reduce dissolved-phase concentrations to the low parts-per-million range to allow natural attenuation to further remediate the site.

The ozone sparging system was operated for eight months, from April through November 1998. Ozone sparging was conducted through a series of six nested sparge points (screens at 12 and 8 feet bgs) to reduce the concentration of the hydrocarbon compounds in both the saturated and unsaturated soils and groundwater. The ozone sparge system was augmented with soil vapor and groundwater extraction using total phase extraction technology and traditional groundwater pumping. Extracted and treated groundwater was reinjected into the subsurface, upgradient of the affected area to further enhance remedial effectiveness by flushing the contaminated area with clean, ozonated water.

### **Results**

Post-remediation soil and groundwater sampling were conducted between January and June 1999 to demonstrate treatment effectiveness. Total BTEX concentrations in groundwater were reduced 86%–99% across the site. MTBE was reduced 97%–98%, and naphthalene was reduced 52%–97% site-wide. Groundwater concentrations continued to decrease during the post-remedial monitoring events, indicating that the source area was effectively remediated and that concentrations will not rebound. Based on post-remedial site monitoring and sampling, LNAPL was removed from the site, and soil and groundwater concentrations at the site were all found to be below the PADEP statewide cleanup standards required for unconditional site closure. Some operational problems were encountered due to fluctuation of line voltage in the area. Subsequently, a variable-frequency drive system was installed to control and regulate voltage conditions to the remediation components.

### **Cost**

Costs for the remediation amounted to \$222,000, including all site investigation activities, permitting, quarterly sampling and reporting, system design, purchase, installation, and operating and maintenance. These costs include two years of post-remediation sampling, reporting, and site closure negotiation with the PADEP.

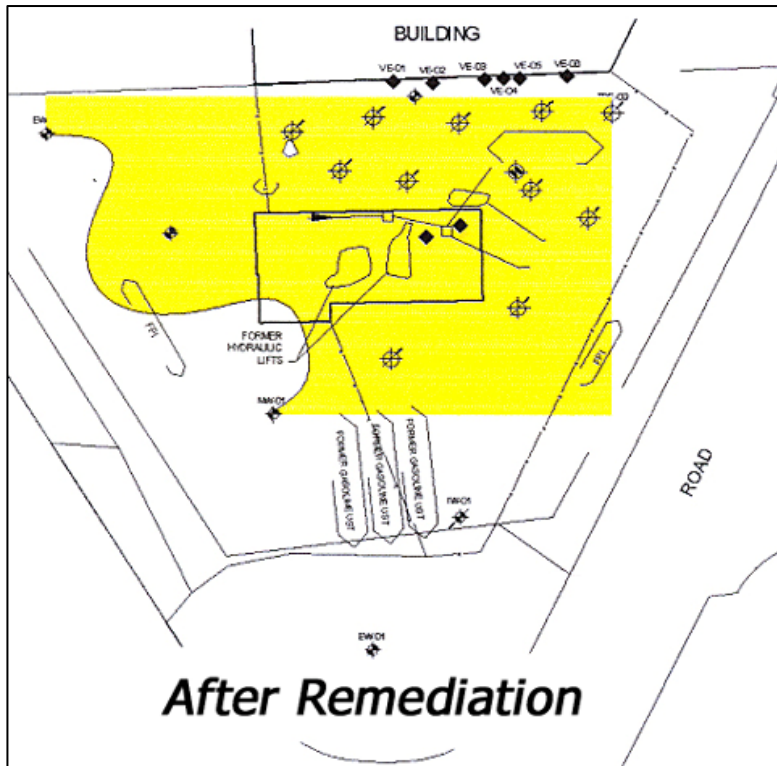

**Site:** Former Fuel Oil Distribution Terminal; Ilion, New York

**Contaminant:** PAH in soil

**Oxidant:** Ozone-oxygen

**Regulatory Agency Contact:** Phillip Waite (315) 785-2513  
New York Department of Environmental Protection

**Technology Contact:** Mr. Scott Miller (856) 273-1009  
Resource Control Corporation

### Site Setting

The subsurface at a former fuel oil distribution terminal in upstate New York contains both fill materials and native soil of primarily silty sand. Groundwater is encountered 7–8 feet bgs. The site was slated for redevelopment, and contaminated soils would have been a problem during installation of utility trenches. No other sensitive receptors were known to be in the immediate area of the site.

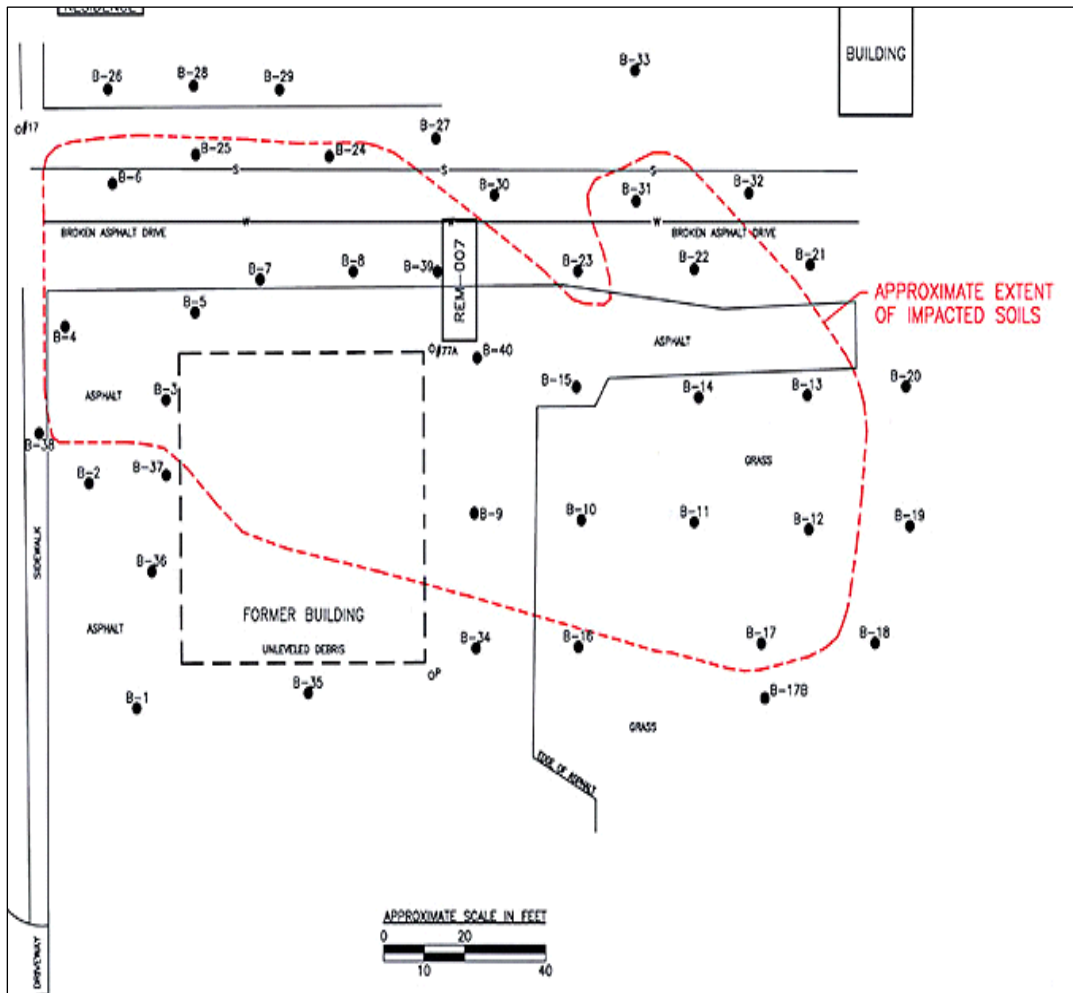

## Description of Target Treatment Volume

The site is a former fuel oil terminal, with soil PAH impacts in an approximate 20,000-square-foot area surrounding the former dispenser loading rack. Adsorbed petroleum impacts were delineated from approximately 2–8 feet bgs, including primarily benzo(a)anthracene, benzo(a)pyrene, benzo(b)fluoranthene, benzo(k)fluoranthene, and chrysene. It was estimated that more than 6,000 cubic yards of soil was impacted. Preremediation contaminant levels of PAH compounds ranged 13,500–32,520 µg/L across the site. Naphthalene was detected in several borings up to 2,500 ppb. Initial total PAH concentrations exceeded 30 mg/kg.

### Targeted PAH contaminant profile, full scale

PAH compound	Concentration (ppb)		TAGM 4046 Standard (ppb)
	Average	Maximum	
Benzo(a)anthracene	1,410	2,900	224
Benzo(a)pyrene	536	1,200	61
Benzo(b)fluoranthene	1,050	2,300	224
Benzo(b)fluoranthene	980	2,500	224
Chrysene	1,077	2,200	400
Total STARS PAHs	13,540	32,520	NA

## Remedial Design

PAH-contaminated soils are typically remediated through excavation and disposal or thermal treatment. Each of those techniques would have required schedules beyond the 60-day period for project completion. To keep to that schedule, a nominal 50-pound/day ozone-generation system was used to inject both ozone and oxygen. A total of 10 initial sparge points were installed at the site by direct-push methodology. A shallow vapor extraction system was installed to control emissions. The vapor extraction system used 17 direct-push installed points. A multipoint, continuous ozone monitoring system was used to measure ambient ozone concentrations and control system operation safely. The injection system was initiated in June 2001 and operated over a period of eight weeks. PAH concentrations [primarily benzo(a)anthracene, benzo(a)pyrene, and chrysene] needed to be reduced up to 90% to meet the NYSDEC TAGM 4046 Standards. The total mass of hydrocarbons in the target zone needed to be reduced by approximately 75% to meet the remedial goals.

## Results

Project target reductions met the NYDEC TAGM 4046 Soil Standards at this site. Post-remediation soil sampling results indicated no remaining PAH mass above method detection limits, for an effective >90% reduction in 60 days. Naphthalene was also reduced to below NYDEC TAGM standards. Average reduction of naphthalene was >32% in 60 days. Some problems were encountered with sparge point construction and unknown fill material present in the vadose zone. However, the system was optimized over time in response to midproject analytical results, allowing the operator to make appropriate adjustments.

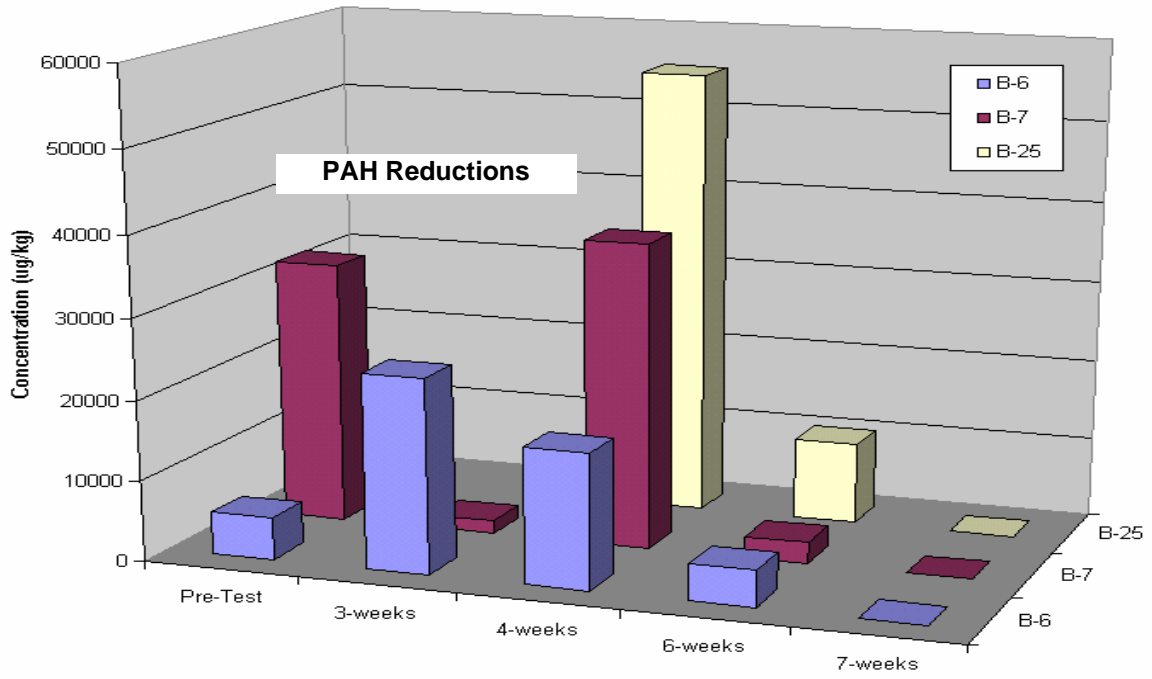

**Cost**

Total cost for this project excluding well costs was \$144,000, or \$24/cubic yard.



**Site:** Former Automobile Sales and Service Center; Bound Brook, New Jersey

**Contaminant:** BTEX

**Oxidant:** Ozone

**Regulatory Agency Contact:** Mr. Frank Camera (609) 633-7840  
New Jersey Department of Environmental Protection

**Technology Contact:** Mr. Scott Miller (856) 273-1009  
Resource Control Corporation

## **Site Setting**

The subject site was a former automobile sales and gasoline service center located in northern New Jersey that was razed for redevelopment as a retail pharmacy. Depth to groundwater ranged 6–12 feet bgs, within glacial fill over weathered shale. The site is in the vicinity of a creek.

## **Description of Target Treatment Volume**

Groundwater impacts were confined to a single monitoring well, and the area of impact was estimated to cover approximately 1,000 square feet.

## **Remedial Design**

The project involved the remediation of residual gasoline contamination of groundwater in the vicinity of a single well following a UST removal and the excavation of contaminated soil and the pumping of groundwater. The objective was to directly oxidize hydrocarbon compounds (BTEX) through reaction with ozone, as well as promote the bioremediation of BTEX through the addition of gas-phase oxygen to the subsurface. Due to time constraints required to mitigate the residual groundwater impacts prior to site redevelopment, a series of four daily ozone injection applications was planned for the site over a two-month period from April to May 2002. During each application, 6% ozone gas in a 90% oxygen stream was injected at a low flow rate (<0.5 scfm) in the saturated zone. A soil vapor extraction system was used to control emissions, as required and adjacent monitoring wells were gauged. The remedial objective was to reduce gasoline contaminants at monitoring well MW-1/1R to below NJDEP cleanup standards in groundwater.

## **Results**

BTEX concentrations in well MW-1/1R were reduced from >11,000 µg/L during the March 2002 sampling event to nondetectable (ND) during the June 2002 sampling event conducted two weeks following the final ozone application. In addition to this 100% reduction in hydrocarbon concentration in well MW-1/1R, associated increases in dissolved oxygen, dissolved carbon dioxide concentrations, and ORP were noted in this well and in well MW-6 located approximately 50 feet away. Post-remediation groundwater sampling and analysis performed in 2003 indicated insignificant rebound in dissolved concentrations that were well below NJDEP cleanup standards.

**Contaminant reduction in MW-1/1R, in µg/L**

<b>Date</b>	<b>Benzene</b>	<b>Toluene</b>	<b>Ethylbenzene</b>	<b>Xylenes</b>	<b>Total BTEX</b>
05/30/2000	160	93	26	240	519
09/20/2000	140	6.2	12	110	268.2
<i>UST excavation and dewatering</i>					
02/05/2001	3.1	ND	ND	1.6	4.7
04/05/2001	4.2	ND	ND	0.4	4.6
06/11/2001	2.9	ND	ND	ND	2.9
09/28/2001	180	88	73	290	631
<i>One vacuum-enhanced groundwater extraction</i>					
01/03/2002	4,600	1,900	1,400	6,100	14,000
<i>Two vacuum-enhanced groundwater extractions</i>					
03/26/2002	3,600	1,700	1,000	5,300	11,600
<i>Four ozone injection applications</i>					
06/17/2002	ND	ND	ND	ND	ND
09/06/2002	ND	ND	0.8	6.4	7.6

**Cost**

This project was completed at a cost of less than \$35,000, including site ozone applications, reporting, and analytical services.

**Site:** Demolished Retail Service Station; Suburban Philadelphia, Pennsylvania

**Contaminant:** Petroleum hydrocarbons

**Oxidant:** Ozone

**Regulatory Agency Contact:** Barbara Bloomfield (610) 832-5949  
Pennsylvania Department of Environmental Protection

**Technology Contact:** Mr. Scott Miller (856) 273-1009  
Resource Control Corporation

### Site Setting

The site is a former retail service station in Bucks County, Pennsylvania. Site soils consisted of silty sand (0–12 feet) underlined by fractured schist and shale. Depth to groundwater is 12–17 feet bgs.

### Description of Target Treatment Volume

Petroleum contamination vapors were detected in nearby utility trenches during utility work in a nearby street. Contamination was also encroaching upon a nearby stream. Dissolved-phase groundwater contaminants were encountered in fractured rock. The approximate area that was treated is 80 × 300 × 17 feet deep (approximately 11,610 cubic yards).



### Remedial Design

The objective was to reduce dissolved and adsorbed hydrocarbons throughout the treatment area as quickly as possible to facilitate a property transfer. The Pennsylvania Department of Environmental Protection (PADEP) approved a proposed remediation system that would simultaneously treat soil and groundwater contaminants by using a SVE and vapor treatment for vadose zone soils, requiring an injection of  $\leq 7$  pounds/day of ozone gas. During the course of remediation a number of parameters were to be measured to ensure that the remediation program was working. These parameters included off-gases collected in the vapor-phase activated-carbon canisters, conductivity, DO, pH, temperature, dissolved ozone, and dissolved petroleum hydrocarbon levels in the groundwater. SVE and ozone sparging were selected due to the volatility and biodegradability of the site contaminants. The remediation system included the installation of 20 ozone sparge wells and 17 SVE wells to a depth of 17 feet and 9 feet, respectively. The SVE and ozone sparging systems started operation on May 2, 2000 and completed operations on August 1, 2000. The remediation system operated reliably with minimal maintenance required. Some small leaks associated with the ozone generating system had to be addressed during start-up; however, the leaks were minor, contained within the system, and easily repaired.

### Results

Ozone sparging into the groundwater significantly reduced dissolved petroleum. Site hydrocarbon levels across the site ranging from 57% at the source area and to an average reduction in

downgradient plume concentrations of 87% in less than four months. All soil samples taken after the conclusion of remediation activities were below PADEP Site-Specific Soil Standards. Final Cleanup Plan approval was received from PADEP after the completion of one round of groundwater sampling in January 2000. Site construction commenced in April 2000 and was completed in less than three weeks from time of mobilization to completion.

### **Cost**

Cost for the project amounted to approximately \$225,000 including site investigation, remedial design, permitting, system install, technology implementation, and post-remediation sampling.

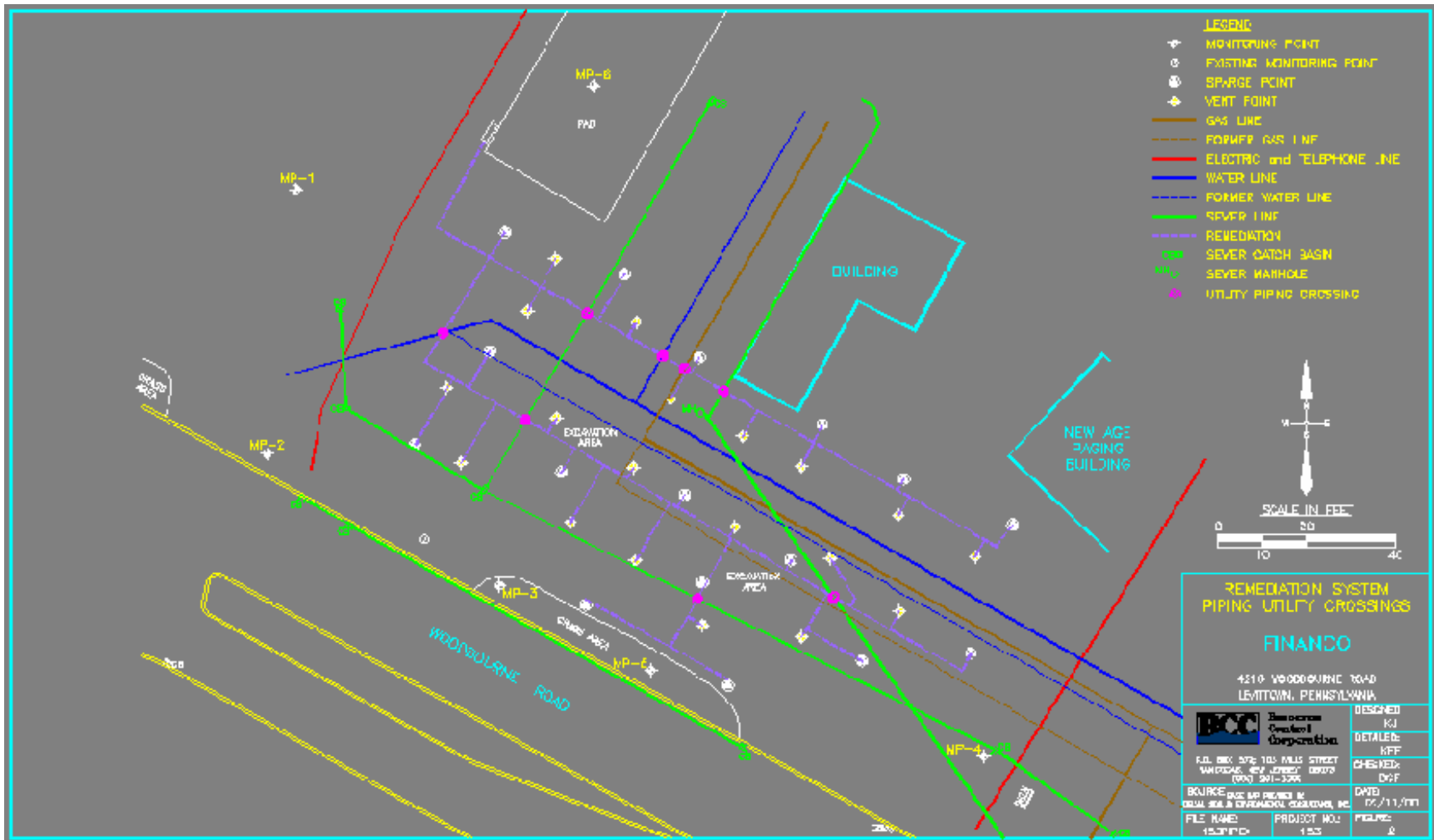

Remediation system piping utility crossings.

**Site:** Former Wood Treatment Site, Sonoma County, California

**Contaminant:** Pentachlorophenol and creosote (i.e., PAHs)

**Oxidant:** Ozone

**Regulatory Agency Contact:** California Department of Toxic Substances Control  
Berkeley, California

**Technology Contact:** Wilson S. Clayton, Ph.D., P.E., P.G.  
Aquifer Solutions, Inc. (303) 679-3143

## Site Setting

The former wood treatment facility (Figure 1) contained creosote and pentachlorophenol dip tanks used for treatment of wood poles. A second area adjacent to a railroad siding was formerly used for off-loading of wood treatment products. The site topography is essentially flat and paved, and the facility is located on northern Sonoma County, California. The site subsurface consists of very heterogeneous stratified silty sands and clays, and the depth to water varies 4–15 feet seasonally. Figure 2 shows subsurface hydrogeology, pretreatment distribution of contaminants, and injection and monitoring facilities in cross-section.

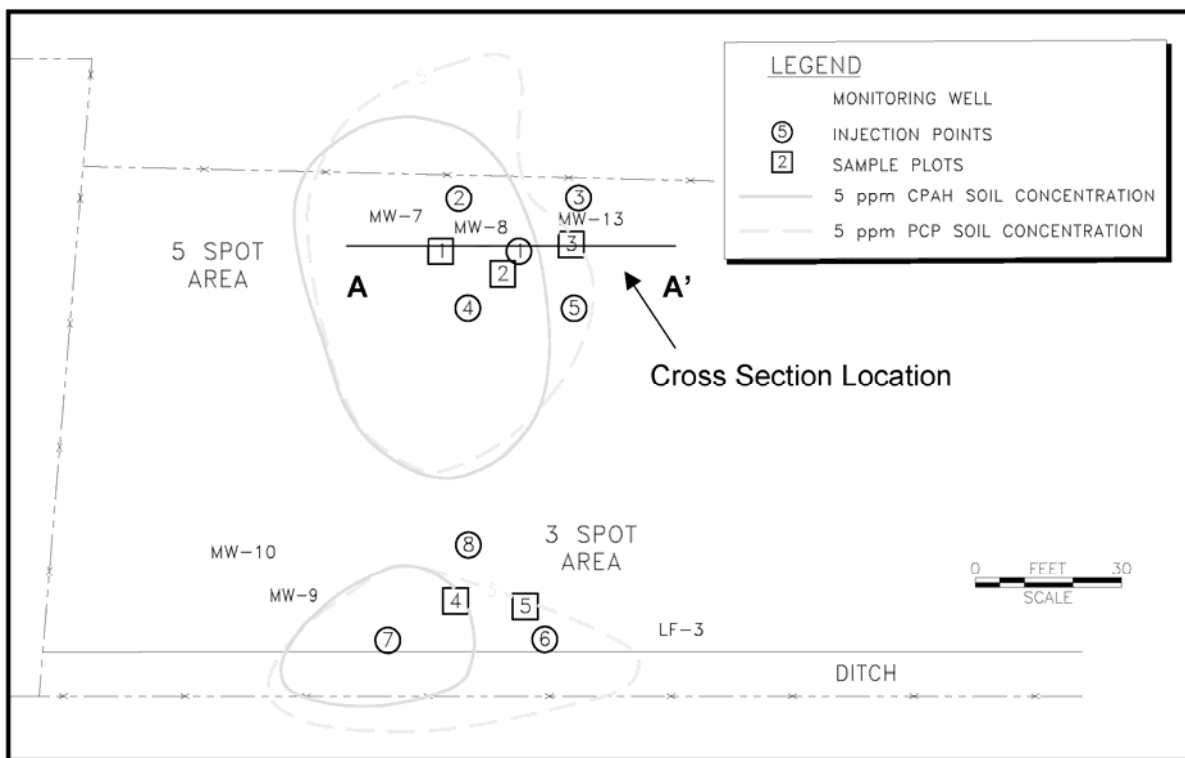

**Figure 1.**

The climate at the site ranges from hot and dry in the summers to extremely wet in winter months. The El Niño wet weather event of 1998 occurred during approximately half of the duration of this long-term pilot demonstration project. As a result of the 1998 El Niño event, depth to groundwater ranged 11–3 feet during the demonstration. This extreme variation in hydrogeologic conditions meant that many of the multilevel ozone injection points acted as ozone sparge points during El Niño but were in the vadose zone during dry months.

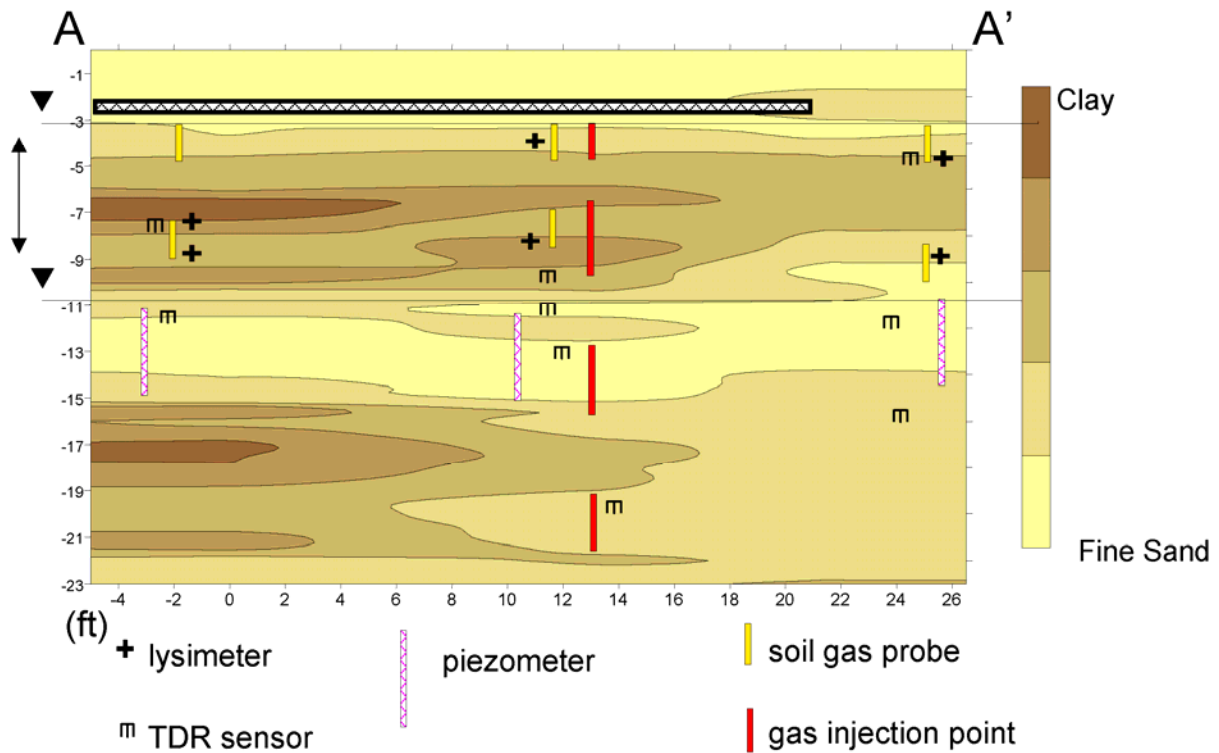

**Figure 2.**

### **Description of Target Treatment Volume**

Site contaminants consisted of pentachlorophenol (PCP) and creosote (i.e., polynuclear aromatic hydrocarbons [PAHs]). Twenty soil samples were collected from the 25- × 25-foot five-spot treatment area prior to ozonation. Maximum pretreatment soil contamination was 220 mg/kg PCP and 5,680 mg/kg total PAHs. High levels of dissolved contamination and NAPL existed in the vadose zone prior to treatment. For example, one pressure-vacuum lysimeter in the vadose zone produced liquid NAPL and water which contained >20,000 µg/L total dissolved PCP and PAH prior to treatment. Dissolved PAHs in groundwater were at low levels and were not a focus of the demonstration project.

Bench-scale slurry-system testing of ozone treatment of the site contaminants indicated that both PCP and PAHs were readily oxidized by ozone. The ozone consumption of site soil or groundwater was not accurately determined during the bench-tests due to ozone losses in the slurry system.

### **Remedial Design**

Both contaminated areas were treated separately during the demonstration project, one with three multilevel ozone injection well locations, and the other with five. This demonstration project was designed to assess the primarily the performance of soil treatment, including the destruction of NAPL present in the vadose zone. The overall site remedial objectives were not determined as part of the technology demonstration project.

The ozone treatment system design included treatment of both the saturated and unsaturated zones. Therefore, ozone gas delivery modes included ozone sparging and ozone gas injection above the water table. In reality, due to the extreme groundwater level changes during the 1998 El Niño event, many of the multilevel ozone injection points acted as ozone sparge points during El Niño but were in the vadose zone during dry months.

Various subsurface monitoring instruments were colocated in sample plots at depths that matched soil sampling depths to evaluate the phase distribution of contamination before, during, and after in situ ozonation treatment. These instruments included soil moisture sensors, pressure vacuum lysimeters to sample vadose zone soil moisture and NAPL, piezometers for groundwater sampling, thermocouples for monitoring subsurface temperature, and soil vapor probes for soil gas monitoring (Figure 2). Soil samples were collected from paired-depths at multiple time points and analyzed for PAHs and PCP.

## Results

Field operation and monitoring of the in situ ozonation demonstration project was conducted from December 1997 through December 1998. Approximately 8,000 pounds of oxidant was delivered to the subsurface, with an average oxidant dose of approximately 1.9 g ozone per kilogram of soil. In general, effective ozone transport and ozone gas mass transfer to the aqueous phase were observed. Ozone concentrations ranging from less than 1 ppm to several hundred ppm were measured in soil gas over the entire area of the monitoring network. These concentrations were several orders of magnitude below the injection concentration of 5% (50,000 ppm), which reflects rapid subsurface ozone reaction and degradation. Dissolved ozone concentrations up to 1.4 ppm were measured in soil moisture samples collected from pressure-vacuum lysimeters.

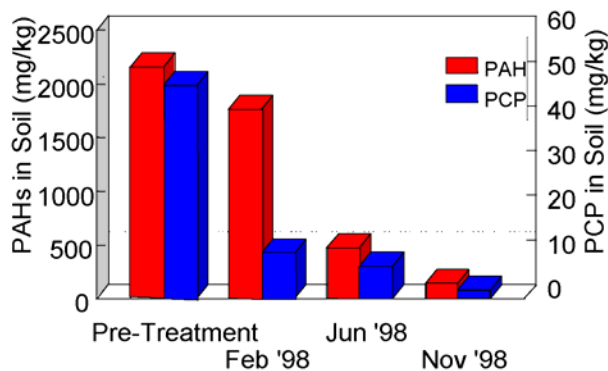

**Figure 3.**

Soil samples collected at paired locations prior to in situ ozonation, and during February, June, and October 1998 showed an average 93% reduction in PCP and PAHs (Figure 3). Concentration at the maximum pretreatment soil contamination was reduced greater than 98%, from an initial value of 220 mg/kg PCP and 5,680 mg/kg total PAHs, to below detection limits.

Significant contaminant mass reduction was reflected not only in soils data, but also in substantial reductions in aqueous-phase concentrations of PCP and PAHs. The lysimeter data showed several orders of magnitude reduction in dissolved PCP and PAHs at the first sampling event, conducted after approximately one month of ozone injection in the five-spot area (Figure 4). In addition, an individual lysimeter (LY-2A) produced liquid NAPL at the beginning of the project but not after one month of treatment.

Figure 5 depicts a series of pie charts of the relative fraction of PCP, and 2-, 3-, 4-, and 5-ring PAHs in soil at two locations before treatment and after >95% treatment. These pie charts indicate that the



ozonation treatment process was nonselective; that is, all contaminant compounds were treated at similar rates. This implies that the in situ ozonation process is not strongly limited by contaminant mass transfer from NAPL and sorbed phases into the aqueous phase. If contaminant mass transfer were limiting, we would expect to see highly preferential treatment of more soluble compounds such as PCP and 2- and 3-ring PAHs, relative to less-soluble compounds such as 4- and 5-ring PAHs. Since this was not the case and since most of the contamination was present in either NAPL or sorbed phases, we infer that under the aggressive ozonation conducted at the site, oxidation reactions occurred largely at the interface between dissolved or gaseous ozone and NAPL or sorbed contaminants.

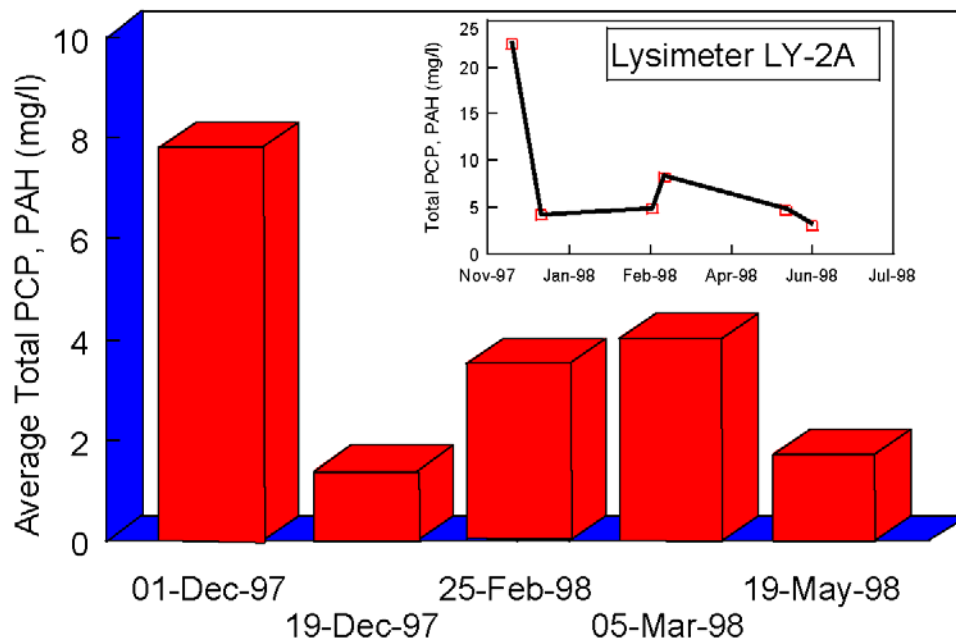

Figure 4.

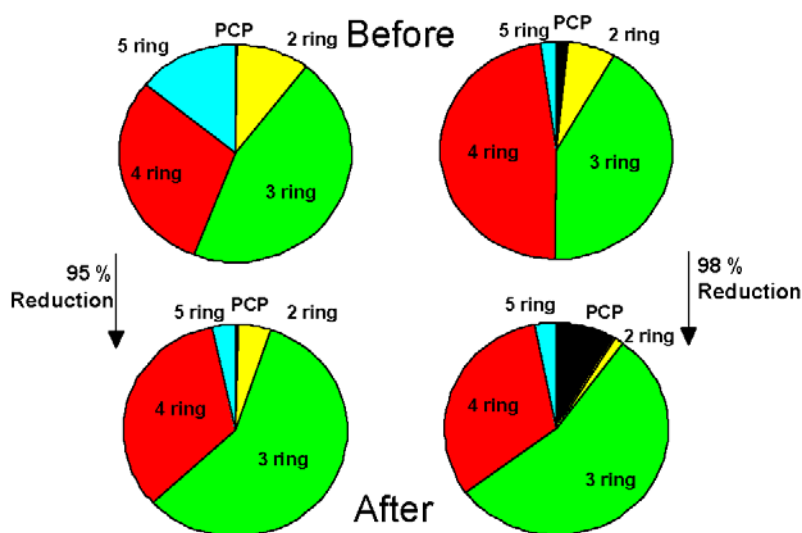

Figure 5.

## **APPENDIX E**

### **ITRC Contacts, Fact Sheet, and Product List**

## ITRC ISCO TEAM CONTACT LIST

Patrick Quinn, Team Leader  
Environmental Engineer  
Missouri Department of Natural Resources  
1738 East Elm Street, Lower Level  
Jefferson City, MO 65101  
Phone: (573) 751-3553  
Fax: (573) 526-5268

Anne W. Callison  
Stakeholder Rep. of Lowry AFB RAB  
Barbour Comm. Inc.  
437 South Pontiac Way  
Denver, CO 80224-1337  
Phone: (303) 331-0704  
Fax: (303) 331-0704

Frank Camera, Technical Coordinator  
NJ Department of Environmental Protection  
401 East State Street, PO Box 413  
Trenton, NJ 08625-0413  
Phone: (609) 663-7840  
Fax: (609) 292-0848

Richard Cartwright, Vice President  
MECX, LLC  
8096 Clarherst Drive  
East Amherst, NY 14051  
Phone: (713) 412-9697

Doug Carvel, President  
MECX, LLC  
6300 West Loop South, Suite 500  
Houston, TX 77401  
Phone: (713) 585-7003  
Fax: (713) 585-7049

Wilson Clayton, Vice President  
Aquifer Solutions, Inc.  
28599 Buchanan Drive  
Evergreen, CO 80439  
Phone: (303) 679-3143  
Fax: (303) 679-3269

Eliot Cooper, National Sales Director  
Vironex  
15267 West Ellsworth Place  
Golden, CO 80401  
Phone: (303) 277-9773  
Fax: (303) 277-9783

Gary Cronk, Senior Project Manager  
Tait Environmental Management  
701 North Parkcenter Drive  
Santa Ana, CA 92705  
Phone: (714) 560-8620  
Fax: (714) 560-8235

Eric Hood  
Geosyntec Consultants  
130 Research Lane, Suite 2  
Guelph, Ontario, Canada  
Phone: (519)822-2230  
Fax: (519)822-3151

Robert Kelley, Team Leader Hazardous  
Remediation  
Carus Chemical Company  
315 Fifth Street  
Peru, IL 61354  
Phone: (815) 224-6681  
Fax: (815) 224-6663

Jeff Lockwood, Technical Review Section  
Florida Dept. of Environmental Protection  
2600 Blairstone Road, MS 4535  
Tallahassee, FL 32399-2400  
Phone: (850) 245-7504  
Fax: (850) 245-8976

Leah MacKinnon  
Geosyntec Consultants  
130 Research Lane, Suite 2  
Guelph, Ontario, Canada  
Phone: (519)822-2230  
Fax: (519)822-3151

Scott Miller, Vice President  
Resource Control Corporation  
1274 N. Church Street  
Moorestown, NJ 08057  
Phone: (609) 352-0668

Nihar Mohanty, Environmental Engineer  
MA Dept. of Environmental Protection  
1 Winter Street  
Boston, MA 02108  
Phone: (617) 654-6515  
Fax: (617) 292-5850

Beth Moore, Research Program Manager  
US DOE-EM 52  
1000 Independence Ave, SW, Rm 3E066  
Washington, DC 20585  
Phone: (202) 586-6334  
Fax: (202) 586-1492

Ian T. Osgerby, Senior Chemical Engineer  
USACE – New England District  
696 Virginia Road  
Concord, MA 07142-2751  
Phone: (978) 318-8631  
Fax: (978) 318-8663

Paul Rodgers, President  
Cedar Creek Engineering, Inc.  
325 A Tierney Way  
Winchester, KY 40391  
Phone: (859) 745-4225  
Fax: (859) 745-4228

Marty Rowland  
Rowland Management Group  
4678 Arts Street  
New Orleans, LA 70122  
Phone: (504) 283-1711  
Fax: (504) 282-4898

Frank Sessa, Environmental Applications  
Specialist  
FMC  
1735 Market Street, Room 1814  
Philadelphia, PA 19103  
Phone: (215) 299-5993  
Fax: (215) 299-6075

Jim Studer, Principal  
Consulting and Funding Resources, LLC  
9900 Lorelei Lane, NE  
Albuquerque, NM 87111  
Phone: (505) 858-3136  
Fax: (505) 857-0364

Linda Warren, Product Manager Hazardous  
Remediation  
Carus Chemical Company  
315 Fifth Street  
Peru, IL 61354  
Phone: (815) 224-6654  
Fax: (815) 224-6663

Laura Yeh, Chemical Engineer  
Naval Facilities Engineering Service Center  
1100 23<sup>rd</sup> Avenue, Code 411LY  
Port Hueneme, CA 93043-4370  
Phone: (805) 982-1660  
Fax: (805) 982-4304

Cain Diehl  
ITRC Program Advisor  
21463 East Shore Route  
Bigfork, MT 59911  
Phone: (406) 370-9255  
Fax: (406) 982-3060