



**Treatability Study Work Plan
In-Situ Soil Flushing Pilot,
Revision 2**

**Nevada Environmental Response
Trust Site, Henderson, Nevada**

Prepared for:
Nevada Environmental Response Trust

Prepared by:
**ENVIRON International Corporation
Chicago, Illinois**

Date:
May 9, 2014

Project Number:
2134800I (I06)



Treatability Study Work Plan, In-Situ Soil Flushing Pilot, Revision 2

Nevada Environmental Response Trust (Former Tronox LLC Site) Henderson, Nevada

Nevada Environmental Response Trust (NERT) Representative Certification

I certify that this document and all attachments submitted to the Division were prepared at the request of, or under the direction or supervision of the Trust. Based on my own involvement and/or my inquiry of the person or persons who manage the system(s) or those directly responsible for gathering the information or preparing the document, or the immediate supervisor of such person(s), the information submitted and provided herein is, to the best of my knowledge and belief, true, accurate, and complete in all material respects.

Office of the Nevada Environmental Response Trust

Le Petomane XXVII, Inc., not individually, but solely in its representative capacity as the Nevada Environmental Response Trust Trustee

Signature: Jay A Steinberg *not individually but solely as President*, not individually, but solely in his representative capacity as President of the Nevada Environmental Response Trust Trustee

Name: Jay A. Steinberg, not individually, but solely in his representative capacity as President of the Nevada Environmental Response Trust Trustee

Title: Solely as President and not individually

Company: Le Petomane XXVII, Inc., not individually, but solely in its representative capacity as the Nevada Environmental Response Trust Trustee

Date: 5/8/14

Treatability Study Work Plan, In-Situ Soil Flushing Pilot, Revision 2

**Nevada Environmental Response Trust
(Former Tronox LLC Site)
Henderson, Nevada**

Responsible Certified Environmental Manager (CEM) for this project

I hereby certify that I am responsible for the services described in this document and for the preparation of this document. The services described in this document have been provided in a manner consistent with the current standards of the profession and, to the best of my knowledge, comply with all applicable federal, state and local statutes, regulations and ordinances.



May 9, 2014

**John M. Pekala, PG
Senior Manager**

Date

Certified Environmental Manager
ENVIRON International Corporation
CEM Certificate Number: 2347
CEM Expiration Date: September 20, 2014

The following individuals provided input to this document:

John M. Pekala, PG, CEM
Allan J. DeLorme, PE
Bruce S. Kennington
Scott D. Warner, PG, CHG, CEG
Laurie LaPat-Polasko, PhD, QEP
Kevin Kyrias-Gann, PE
Beth Richter
Chris Stubbs, PhD
Kim Kuwabara, CEM
Ruben So

Contents

	Page
1 Introduction	1
1.1 Background / Regulatory Status	1
1.1.1 Groundwater Contamination	1
1.1.2 Soil Contamination	1
1.2 Purpose and Objectives	2
1.2.1 Preliminary Field and Laboratory Testing	2
1.2.2 Pilot Testing	3
1.3 Work Plan Organization	3
2 Work Performed by Others	5
3 Candidate Installation Location	7
4 Site Conditions	8
4.1 Local Geology	8
4.2 Perchlorate in Soil	8
4.3 Hydrology	8
4.4 Perchlorate in Groundwater	9
5 Preliminary Field and Laboratory Testing	10
5.1 Permeameter Testing	10
5.2 Laboratory Column Testing	10
6 Preliminary Pilot System Design & Operation	13
6.1 Preliminary Design	13
6.1.1 Flushing Volume	13
6.1.2 Hydraulic Loading	14
6.1.3 Groundwater Mounding	14
6.1.4 Potential Impacts to the GWETS	15
6.2 Flushing Liquid Delivery System Operation	16
6.3 Permitting	17
7 Pilot System Monitoring	19
7.1 Leachate Monitoring	19
7.2 Soil	19
7.3 Groundwater Monitoring	20
8 Reporting	22
9 Schedule	23
10 References	24

List of Tables:

Table 1:	Water Sample Analytes and Methods
Table 2:	Soil Sample Analytes and Methods
Table 3:	List of Planned Groundwater Monitoring Wells and Piezometers

List of Figures:

Figure 1:	Site Location Map
Figure 2:	Proposed Pilot Test Location
Figure 3:	Perchlorate Concentrations in Soil near the Proposed Pilot Test Location
Figure 4:	Utilities near the Proposed Pilot Test Location
Figure 5A:	Projected Capture Zone – Interceptor Well Field
Figure 5B:	Projected Capture Zone – Interceptor Well Field and Athens Road Well Field
Figure 6:	Groundwater Potentiometric Surface near the Proposed Pilot Test Location
Figure 7:	Perchlorate Concentrations in Groundwater near the Proposed Pilot Test Location
Figure 8:	Soil Flushing Process Flow Diagram
Figure 9:	Pilot Test Monitoring Layout – Soil Flushing Treatability Study
Figure 10:	Preliminary Time Schedule for In-situ Soil Flushing Treatability Study

List of Appendices:

Appendix A:	Boring Logs and Well Construction Diagrams
Appendix B:	ENVIRON Standard Operating Procedures
Appendix C:	Groundwater Mounding Estimates
Appendix D:	Perchlorate Mass Loading Rate Estimates

Acronyms and Abbreviations

AP	ammonium perchlorate
AWF	Athens Road Well Field
BHC	benzene hexachloride
BCL	Basic Comparison Level
bgs	Below ground surface
COPCs	Chemical of Potential Concern
ECA	Excavation Control Area
ENVIRON	ENVIRON International Corporation
FBRs	Fluidized Bed Reactors
f_p	Infiltration rate
GIS	geographic information systems
g/L	grams per liter
GWETS	Groundwater Extraction and Treatment System
H	Recharge head
HDPE	high-density polyethylene
ISM	In-situ microcosm
IWF	Interceptor Well Field
K_{sat}	saturated hydraulic conductivity
L	Depth to wetting front
mg/L	milligrams per liter
mg/kg	milligrams per kilogram
mL/min	milliliters per minute
NERT	Nevada Environmental Response Trust
NDEP	Nevada Division of Environmental Protection
Northgate	Northgate Environmental Management, Inc.
NPDES	National Pollutant Discharge Elimination System
NRS	Nevada Revised Statutes
PVC	polyvinyl chloride
Qal	Quaternary Alluvium
RAO	Remedial Action Objective
RI/FS	Remedial Investigation / Feasibility Study

S _f	Suction (capillary) head
Site	NERT Site
SOP	Standard Operating Procedures
SRG	Site Remediation Goal
SWF	Seep Well Field
TDS	total dissolved solids
TOC	total organic carbon
Trust	Nevada Environmental Response Trust
TSS	total suspended solids
UMCf	Upper Muddy Creek Formation

1 Introduction

ENVIRON International Corporation (ENVIRON), on behalf of the Nevada Environmental Response Trust (NERT or “the Trust”), has prepared this Treatability Study Work Plan (the “Work Plan”) for In-Situ Soil Flushing for the Nevada Division of Environmental Protection (NDEP). This Work Plan details the pilot test conceptual design, preliminary laboratory-scale evaluations, and preliminary field work necessary for conducting an in-situ soil flushing pilot test (“pilot test”) at the NERT Site in Clark County, Nevada (the “Site”). The location of the Site is shown in Figure 1. The proposed pilot testing continues and builds on a preliminary evaluation of soil flushing technology conducted by Tronox in 2010.

This Work Plan has been prepared and is being submitted as part of the Remedial Investigation (RI) and Feasibility Study (FS) for the Site, pursuant to the Interim Consent Agreement entered into by the Trust effective February 14, 2011. A RI/FS Work Plan to address soil and groundwater contamination at the Site was submitted to NDEP on December 27, 2012. The RI/FS Work Plan was reviewed by NDEP and various stakeholders during 2013 and a revised work plan, addressing and incorporating comments from NDEP and stakeholders was submitted to NDEP on January 10, 2014. NDEP provided comments on the RI/FS Work Plan on April 25, 2014, with revisions due for submittal to NDEP by May 25, 2014. The RI/FS Work Plan and this revised Treatability Study Work Plan are anticipated to be reviewed by NDEP during May and June 2014. Implementation of this work plan is dependent on NDEP approval of the work plan and associated budgetary approval.

1.1 Background / Regulatory Status

1.1.1 Groundwater Contamination

The Site has employed an active groundwater pump and treat system to remove hexavalent chromium (since 1986) and perchlorate (since 1998), from groundwater under NDEP’s oversight. The groundwater extraction and treatment system (GWETS) includes three extraction well fields: the on-site Interceptor Well Field (IWF), the off-site Athens Road Well Field (AWF), and the Seep Area Well Field (SWF). Groundwater collected from the IWF is first treated to reduce hexavalent chromium to trivalent chromium through a ferrous sulfate treatment system. After the ferrous sulfate treatment process, perchlorate is treated using perchlorate-reducing bacteria in a series of fluidized bed reactors (FBRs). Groundwater extracted from the AWF and SWF is discharged directly to the FBR process for perchlorate removal. Following treatment in the GWETS, groundwater is discharged to the Las Vegas Wash under a National Pollutant Discharge Elimination System (NPDES) permit (NV0023060).

1.1.2 Soil Contamination

In accordance with a 2009 NDEP Consent Order signed by Tronox and NDEP, Tronox prepared a Removal Action Work Plan to remove shallow soil (between 0 and 10 feet below ground surface(bgs)) containing chemicals of potential concern (COPCs) above NDEP approved Site Remediation Goals (SRGs). These removal activities were commenced by Tronox in August 2010 and were completed by the Trust in November 2011 (ENVIRON, 2012a). An estimated 567,770 cubic yards of contaminated Site soils were excavated during the removal action. The removal action significantly reduced contaminant mass at the Site, however contaminant

concentrations – primarily perchlorate – in the remaining vadose zone soils at the Site continue to pose a potential threat to underlying groundwater.

1.2 Purpose and Objectives

The purpose of this Work Plan is to present the steps necessary to design, install, operate and monitor an in-situ pilot system (the “pilot system”) to fully evaluate the potential for this technology to remove perchlorate from vadose zone soils under actual field conditions at the Site.

As stated above, the previous removal action only addressed shallow soils (i.e., less than 10 feet bgs) to mitigate direct contact risks. Deeper soils impacted by perchlorate were not addressed as part of this removal action. ENVIRON has estimated that approximately 1,300 tons of perchlorate are present in on-site vadose zone soils following the 2011 remedial action. This mass estimate was calculated using geographic information systems (GIS) software and the Thiessen Polygon method over multiple depth intervals to interpolate the post-remediation soil sample results. Such areas of the Site are now being addressed as part of the overall Remedial Investigation / Feasibility Study (RI/FS) process, a component of which is to identify feasible and cost-effective technologies that could be effective in meeting the groundwater Remedial Action Objectives (RAOs) for the Site. In-situ soil flushing has been identified as a promising technology that could be useful in meeting these RAOs.

Perchlorate is highly soluble in water – approximately 200 grams per liter (g/L) at 20 degrees Celsius – making it a good candidate for removal by soil flushing. This has been verified in preliminary laboratory column testing (see Section 2) that demonstrated this technology has the potential to reduce perchlorate concentrations in Site vadose zone soils by up to 99% (Prima, 2010). Flushing of perchlorate from vadose zone soils would serve to accelerate the rate at which perchlorate would naturally leach from such soils to underlying groundwater, which would then be captured and treated in the GWETS. If successful, this would reduce the overall mass of perchlorate present in soils at the Site and decrease the time frame necessary to achieve RAOs. The pilot system will provide necessary information to allow evaluation, under field-scale conditions, of the feasibility, cost-effectiveness, and expected performance of this technology.

This in-situ soil flushing treatability study has been developed in two primary phases; 1) Preliminary Field and Laboratory Testing, and 2) Pilot Testing. The objectives of these two phases are described below.

1.2.1 Preliminary Field and Laboratory Testing

Preliminary field and laboratory testing is proposed to provide necessary information for the further evaluation of the performance of the technology, as well as for the design of the pilot system. The testing program will also evaluate the use of alternative flushing liquids (Lake Mead water versus GWETS effluent) and the potential for the technology to stimulate biodegradation of perchlorate in-situ, prior to implementation at the field scale.

The specific objectives of the field and laboratory tests are to:

- Determine the mass of perchlorate within the proposed pilot system location. This information can then be used to evaluate the performance of the technology in removing perchlorate from soils;
- Determine in-situ hydraulic conductivity and porosity of the soils at the proposed pilot system location to aid in the design of the pilot system and to confirm the preliminary assessment of the pilot system's projected impact on local water levels and GWETS capture zones;
- Provide a preliminary assessment of the mass of perchlorate that can be effectively removed from soils at the Site and the volume of flushing liquid necessary to achieve various removal efficiencies;
- Determine the relative effectiveness of using Lake Mead water and GWETS effluent in removing perchlorate from soils and assess other operational concerns (e.g., mobilization of other COPCs) using these flushing liquids;
- Identify and quantify the presence of other COPCs that could be mobilized by the flushing process; and
- Assess the potential for biological reduction of perchlorate and biofouling during soil flushing.

1.2.2 Pilot Testing

Upon completion of the Preliminary Field and Laboratory Testing described in Section 1.2.1, the pilot system will be designed and the pilot testing program will be implemented.

The pilot test will build on the laboratory testing by providing information to determine the effectiveness of soil flushing under actual field conditions at the Site.

The specific objectives of the pilot test are to:

- Evaluate the performance of soil flushing technology to reduce the mass of perchlorate in soils under field conditions;
- Evaluate the degree to which other COPCs are mobilized during flushing operations;
- Evaluate whether significant microbial degradation of perchlorate in vadose zone soils can be stimulated by the flushing process and assess the potential for biofouling under field conditions;
- Evaluate the potential impact of soil flushing on the operation and capacity of the GWETS;
- Determine the extent and impact of soil flushing-induced groundwater mounding on the groundwater table elevation and IWF capture zone; and
- Determine the optimal operational conditions for the pilot system.

1.3 Work Plan Organization

This Work Plan document is organized as follows:

- Section 2 presents a summary of relevant work done by others;

- Section 3 presents the proposed candidate location for the pilot system on the Site;
- Section 4 presents the conditions at the Site in the proposed pilot test location;
- Section 5 presents the preliminary field and laboratory testing proposed to be performed to enable final design of the pilot system;
- Section 6 presents the preliminary design of the pilot system along with operational considerations;
- Section 7 details the monitoring to be performed during the operation of the pilot system;
- Section 8 describes the reports of results of the pilot testing to be prepared;
- Section 9 presents the proposed schedule; and
- Section 10 details the references used in compiling this Work Plan.

Figures and tables are presented at the back of the report text, followed by the Appendices.

2 Work Performed by Others

A preliminary assessment of soil flushing as a remedial option for Site soils was initiated by Northgate (on behalf of Tronox) in 2010 (Northgate, 2010a). As part of their feasibility assessment, Northgate commissioned column tests using Site soil and groundwater to enable bench scale evaluation of perchlorate removal via soil flushing and the resultant influence on metals mobilization (Prima, 2010).

The column tests used homogenized Site soils containing low (6.18 milligrams per kilogram (mg/kg)), medium (145 mg/kg) and high (3,310 mg/kg) concentrations of perchlorate. Approximately 2 pore volumes of stabilized Lake Mead water was added to the columns at a rate of 2 milliliters per minute (mL/min). The column tests determined that the water percolated steadily into the soils at a rate of 30 to 40 inches per day when continuously applied. The addition of 2 pore volumes of the water achieved greater than 99% removal of perchlorate from all three columns by the end of the study¹. In addition to mobilizing perchlorate, the following constituents were detected in at least one leachate sample during the column test: chloride, fluoride, nitrate, sulfate, ammonia, chlorate, total dissolved solids (TDS), total organic carbon (TOC), total suspended solids (TSS), arsenic, boron, calcium, chromium, cobalt, iron, magnesium, manganese, potassium, sodium, uranium, and beta benzene hexachloride (BHC) (Prima, 2010).

The tests concluded that soil flushing appeared to be an effective method of removing perchlorate from soil; that metals concentrations in the leachates generally increased in the initial samples but then decreased; and that further work was necessary to determine the amount of Lake Mead water needed to ensure complete flushing of perchlorate from vadose zone soils at the Site (Prima, 2010).

Following completion of the column tests, Northgate submitted a work plan (Northgate, 2010a) for field scale pilot testing at the Site. The work plan was initially submitted to NDEP on March 29, 2010 and was revised on May 27, 2010 and again on November 11, 2012 to address comments from NDEP, which were provided on April 16, 2010, June 21, 2010, and November 1, 2010. In February 2011, the Trust assumed ownership of the Site, following which the Trust and NDEP discussed the implementation of a RI/FS at the Site. As a result, the Northgate plan was not implemented and it was agreed that any treatability studies would be evaluated and proposed as part of the RI/FS. ENVIRON has reviewed the Northgate work plans along with the

¹ The 99% percent removal is based on the results of sampling the soil in the columns pre- and post-flushing. Prima also looked at mass removed using the leachate sampling results, which indicated that only 33% and 67% percent of perchlorate was removed from the columns tested, based on perchlorate analytical results of pre-flushing soil samples. Although the Prima report does not identify a reason for this discrepancy in the estimated mass removed, potential causes include non-uniform distribution of perchlorate in the soil columns, ineffective homogenization of the soil in the soil columns, or biodegradation within the soil columns that was not accounted for during testing. These anomalies do not in themselves alter the overall conclusion that soil flushing is effective at removal of perchlorate from vadose zone soils and that further evaluation through pilot testing is needed.

associated NDEP comments and has incorporated relevant details into this Work Plan. The proposed pilot testing herein continues and builds on the preliminary evaluation of soil flushing technology and proposed pilot testing previously presented by Northgate.

3 Candidate Installation Location

ENVIRON is proposing to conduct the pilot test in the area southeast of the BT Tank Farm as shown in Figure 2. This candidate location was selected based on the following rationale:

- Perchlorate is consistently present in vadose zone soils at elevated concentrations (i.e., greater than the Basic Comparison Level [BCL] of 795 mg/kg). The presence of perchlorate at these concentrations generally represents areas which may be significant sources of perchlorate to underlying groundwater and potentially would be targeted for remedial action. Figure 3 shows perchlorate concentrations in soil at the proposed pilot test location. Post-excavation soil concentrations of perchlorate in the top 10 feet of soil at the Site range from 943 to 2,620 mg/kg based on soil samples collected from locations RSAM5, SA15 and SA65 (Northgate 2010c).
- The proposed location is outside of the excavation control areas (ECAs) established in the Site Management Plan.
- Required utilities, including sources of GWETS effluent water, Lake Mead water, and electricity, are present in the vicinity of the proposed pilot location (Figure 4). Existing piping and tanks may be utilized to supply the source of flushing liquid to the proposed location.
- The proposed location is within the projected capture zone of the IWF (Figure 5a) and the AWF (Figure 5b), and is in an area where the surface of the Upper Muddy Creek Formation (UMCf) slopes toward the IWF. Accordingly, soil flushing at the proposed location will result in capture and treatment of flushing liquids and other constituents mobilized by the pilot test.
- The proposed location is out of the way of on-going operations (e.g., GWETS and Tronox operations), but is located within the Site's active central storm water collection basin.

ENVIRON notes that since the completion of the soil excavation activities, the maximum ponded water depth in the central basin was approximately three to six inches after an approximately 1.65-inch precipitation event over a 24-hour period at the Site in August 2012. According to National Oceanic and Atmospheric Administration precipitation frequency estimates, a 1.65-inch storm event over 24-hours has a 10-year average return period. Given the relatively shallow depths of storm water observed after this storm and the low frequency of large storm events in the region, pilot operations should not be impeded by storm events at this location. As discussed further in Section 5, the pilot system will be constructed to prevent storm water that is collected in the basin from impacting pilot operations.

Based on the available data and conditions at the Site, the candidate installation location will allow for assessment of the stated pilot test objectives. This area may be subject to change based on the results of the preliminary field work discussed in Section 4. A location change, if necessary, will be discussed as a part of the final pilot test design submittal.

4 Site Conditions

4.1 Local Geology

Local geology and hydrology at the Site have been established by data collected from more than 1,100 borings and wells that have been installed in the area. The following provides a summary of the geology in the area of the proposed pilot system based on borehole logs from borings installed in the area (as presented in Appendix A), and accounting for removal of the upper 10 feet of shallow soil during remedial excavations in 2010/2011 (ENVIRON, 2012c).

- **Fill Material** generally is not present in the location of the proposed pilot system; although it is present in other areas of the Site.
- **Quaternary Alluvium (Qal)** generally comprises brown to yellowish brown heterogeneous horizons of sand, gravel and clay with varying degrees of silt content throughout. The gravel is not fully described but is likely to be similar to that across the rest of the Site, i.e., fine, sub-rounded volcanic rock. Caliche (hardened deposits of calcium carbonate) is also recorded as thin bands (up to 4 feet thick) of nodules and was encountered at varying depths, most notably in borehole SA15 where it was encountered from 10 feet bgs (the current ground surface) in bands to approximately 22 feet bgs (immediately above the underlying Muddy Creek formation).
- **Tertiary Upper Muddy Creek Formation (UMCf)** is known to underlie the alluvial deposits but was recorded in only two locations near the area of the proposed pilot system. At SA15 the UMCf was encountered at 22 feet bgs and was described as light brown slightly sandy silt. The full thickness of the UMCf was not determined at SA15 as the boring terminated within the formation at 30 feet bgs. The Muddy Creek Formation was also encountered in monitoring well M-111A at 34 feet below pre-excavation ground surface (24 feet below current ground surface); M-111A was removed during the soil excavation work in 2011.

4.2 Perchlorate in Soil

In the area near the proposed pilot system, the Phase A and B investigations data indicate perchlorate concentrations ranging from 943 (SA-15 at 10 feet bgs) to 2,620 mg/kg (RSAM5 at 1.0 to 2.3 feet bgs) in shallow vadose zone soils (Northgate, 2010c) that remained following the soil removal action. Figure 3 shows perchlorate concentrations in soil at the proposed pilot system location. Other areas with elevated perchlorate concentrations (e.g., greater than 1,000 mg/kg) include the former ammonium perchlorate (AP) manufacturing areas near the current GWETS system, AP-5 pond and Central retention basin; and in soils near Units 4 and 5.

4.3 Hydrology

Figure 6 shows the potentiometric surface map for the proposed pilot system location based on data presented previously (ENVIRON, 2012c). Due to the influence of the IWF, groundwater is typically only found in the UMCf under the proposed pilot test location. The groundwater flow direction at the Site is generally to the north to slightly west of north. Patterns in the direction of groundwater flow may be affected locally by subsurface alluvial channels present within the underlying UMCf, the on-site bentonite-slurry groundwater barrier wall and by the hydraulic influence of the groundwater extraction wells at the three groundwater recovery well fields

(Northgate, 2010b). The monitoring wells around the proposed pilot test location were removed during the 2010/2011 soil excavation so the depth to groundwater can only be estimated. Based on water levels taken at M-111a in 2010 and groundwater contouring in Figure 6, the approximate depth to groundwater is 22 feet bgs.

4.4 Perchlorate in Groundwater

Perchlorate concentrations in shallow groundwater vary across the Site. Based on November 2011 analytical results (ENVIRON, 2012b), the highest perchlorate concentrations detected were:

- South of the barrier wall (i.e., in groundwater upgradient from the GWETS): 2,200 milligrams per liter (mg/L) (well I-AR);
- North of the barrier wall: 1,100 mg/L (M-72); and
- North of the former recharge trenches: 610 mg/L (M-44).

Figure 7 shows groundwater concentrations in the area of the proposed soil flushing pilot location to be approximately 250 mg/L.

5 Preliminary Field and Laboratory Testing

As described in Section 1.2, prior to implementation of the pilot test, additional data will be collected to evaluate the field conditions at the proposed location of the test, as well as evaluate the relative effectiveness of the potential flushing liquids. These data will then be used in the design of the pilot system and monitoring program.

5.1 Permeameter Testing

A constant head permeameter will be utilized to determine the saturated hydraulic conductivity of the soils above the groundwater table in the proposed pilot test location. Saturated hydraulic conductivity information will be used to determine the application or dosing rate that can be used for the pilot cells and to size the conveyance system for the flushing liquid. A review of soil borings in the pilot test area indicate that stratified layers exist in the subsurface that may have a wide range of saturated hydraulic conductivity (K_{sat}) values. Therefore, the permeameter tests will be conducted at multiple depths within the vadose zone to quantify the K_{sat} at varying depths of the vadose zone soils.

Permeameter testing will be conducted using a 2840K2 Aardvark Permeameter following the methods provided for in the Standard Operating Procedure (SOP) included in Appendix B. Tests are planned to be run at depths of 1, 5, 10, 15, and 20 feet bgs at four locations within the proposed pilot test area. To create the borehole necessary to conduct the testing at the various depths, soil borings will be advanced using a Mini Sonic drilling rig and soils will be logged by an experienced field geologist. Based on conditions encountered, additional permeameter tests may be run if significant differences in lithology are observed.

5.2 Laboratory Column Testing

The preliminary laboratory study on soil flushing conducted by Tronox (Prima, 2010) used stabilized Lake Mead water as a flushing liquid. As described previously, this study concluded that flushing was effective at removing greater than 99% of perchlorate mass present in the laboratory columns containing Site soils. It was generally concluded from this study that soil flushing using stabilized Lake Mead water is a potentially effective alternative for removal of perchlorate from vadose zone soils at the Site.

In evaluating soil flushing technology for potential application at the Site, ENVIRON believes that additional benefits could be attained by using GWETS effluent as a flushing liquid in place of stabilized Lake Mead water. Specifically, the use of GWETS effluent could potentially provide substantial cost savings and would be considered a superior alternative with respect to sustainability given that treated effluent would simply be discharged (recycled) back to the Site shallow groundwater.

Assuming that soil flushing was employed full-scale at the Site, ENVIRON's preliminary calculations indicate that cost savings of approximately \$23,000 per acre² of soil flushed could be achieved based only on the reduced volume of Lake Mead water that would need to be purchased (approximately 20 million gallons per acre). Additional incremental cost savings would be achieved through reduced pumping (electricity) requirements. Additionally, the available nutrients and the reducing redox conditions present in the GWETS effluent water, could serve to stimulate microbial degradation of perchlorate in the vadose zone which would enhance removal during soil flushing operations. Therefore, GWETS effluent will be considered for use as a flushing fluid and evaluated during the laboratory column testing.

Laboratory column tests will be performed at an off-site laboratory. Four columns will be constructed. Two columns will be used to assess the leaching properties of perchlorate and other COPCs using stabilized Lake Mead water and GWETS effluent as flushing liquids, respectively. Two additional columns will be used to assess the microbial degradation of perchlorate during soil flushing using each flushing liquid. The laboratory columns will be approximately six feet long and constructed from 6-inch clear PVC or equivalent pipe following the column design in ASTM D4874-95 (Standard Testing Method for Leaching Solid Material in a Column Apparatus).

The columns will contain alluvium (Qal) soil taken from the soil borings installed during the permeameter testing described in Section 5.1. Soils will be homogenized at the laboratory, and sampled and analyzed for the physical, chemical, and biological parameters listed in Table 2 prior to conducting the column test. The soil in each column will be packed to approximate in-situ soil density (110 – 130 pounds per cubic foot) and moisture content (5-10% by volume). After completion of the flushing tests as described below, the soil will be removed from the columns, and sampled and analyzed for the same physical, chemical and biological parameters.

Approximately 15 gallons of each flushing liquid will be collected from sample ports on the GWETS effluent and Lake Mead water lines at the Site, shipped to the laboratory and sampled and analyzed for the parameters listed in Table 1 prior to conducting the column test. The two columns designed to evaluate the leaching properties of perchlorate and other COPCs will be flushed with two pore volumes of flushing liquid at a flow rate of 2 mL/min. The progress of the wetting front will be monitored daily until break through. Once the flushing liquid breaks through at the bottom of the column, a sample will be collected and analyzed for the constituents listed in Table 1. Samples will be collected daily after break through until two pore volumes of liquid have been collected from each column. Based on the observations from the previous laboratory study on soil flushing conducted by Tronox (Prima, 2010), it is expected to take about 10 days to flush 2 pore volumes through the columns.

The two biological columns will be flushed with one pore volume of flushing liquid at a flow rate of 0.5 mL/min. Using the thickness of the vadose zone at the planned pilot location and

² A cost savings of \$23,000 per acre was estimated assuming a pilot cell area of 10,000 square feet, a vadose zone thickness of 22 feet, a porosity of 0.38, a cost of stabilized Lake Mead water of \$1.09 per 1,000 gallons, and that 8 pore volumes are required to effectively flush the soils.

depending on how much of the available pore spaces would be filled, the estimated time to flush a single pore volume in the field could range from as little as 7 days to as many as 30 days. The slower flow rate of 0.5 mL/min was therefore chosen to allow for flushing liquid to stay in contact with soil for a longer period of time. This will allow for an evaluation of the potential for growth of perchlorate-reducing microorganisms under simulated field conditions. The progress of the wetting front will be monitored daily until break through. Once flushing liquid breaks through at the bottom of the column, a sample will be collected and analyzed for the constituents listed in Table 1. Samples will be collected daily after break through the end of the test. At the 0.5 mL/min flow rate and based on the observations from the previous laboratory study on soil flushing conducted by Tronox (Prima, 2010), it is expected to take about 40 to 50 days to flush two pore volumes through the columns.

The results of the column tests will be used to evaluate the performance of each flushing liquid, providing information that will be used during the design of the pilot system. A discussion of the column tests and results along with analysis of the impact of the flushing liquid on the GWETS will be presented in a report as discussed in Section 8.

6 Preliminary Pilot System Design & Operation

The following section discusses the preliminary design and operation of the pilot system based on site-specific data collected and reported to date. The design and operation of the pilot system will be reassessed and potentially refined based on the results of the preliminary field and laboratory testing described in Section 5.

In preparation of this preliminary design, ENVIRON considered various methods of applying flushing liquids including: 1) application of liquids at the ground surface under constant head within a bermed area; and 2) injection of liquids below ground surface via injection galleries (e.g., perforated piping, drip irrigation hose) or trenches. Subsurface application of flushing liquids would require excavation for installation of the injection galleries. If applied at the Site in full-scale, this type of system could involve considerable amounts of excavation and associated soils management, complicating installation and reducing cost-effectiveness. Specifically, a subsurface system likely would entail significantly greater capital costs for construction due to excavation, increased requirements for soil management, fugitive dust monitoring, and general health and safety requirements. Accordingly, surface application was selected as the preferred method of delivery of flushing liquids in the design of the pilot system.

6.1 Preliminary Design

Although a final detailed design cannot be established until additional data is collected, a preliminary design was completed using available data in order to determine approximate sizing and anticipated operational conditions and monitoring schedules during the pilot test. The primary design considerations relate to hydraulic loading, limiting groundwater mounding, and mitigating impacts to the GWETS.

6.1.1 Flushing Volume

Determining the volume of liquid required to flush leachable perchlorate from the vadose zone soils is an objective of the pilot test. For the purpose of the preliminary design, an estimate was made using the previously collected column test data (Prima, 2010). The column testing determined that 99% of perchlorate was removed after approximately two pore volumes of flushing liquid were passed through the column.

Flushing of soils in-situ is, however, expected to require higher volumes of flushing liquid than that observed in the laboratory due to the effects of heterogeneities in soil structure, anisotropies of hydraulic properties, and the increased depth of contamination. Collectively, these properties will tend to create a more highly tortuous path for flushing liquids which could extend laterally outside the footprint of the pilot system. This phenomenon has been demonstrated at the field-scale in soils similar to those present at the Site (Glass, 1996). Based on review of these considerations reported in literature and the varying soil structures observed in available boring logs from the Site, a minimum of 4 pore volumes and, conservatively, as many as 8 pore volumes have been estimated to achieve similar levels of perchlorate removal in-situ.

6.1.2 Hydraulic Loading

Hydraulic loading will be determined based on the saturated hydraulic conductivity determined by the permeameter testing described in Section 5.1. The soil horizon with the lowest saturated hydraulic conductivity will be used to calculate the infiltration rate for the pilot test. The infiltration rate can be calculated using the Green-Ampt equation:

$$f_p = \frac{K_{sat}(H + S_f + L)}{L}$$

Where:

f_p = The infiltration rate

K_{sat} = Saturated soil conductivity

H = Recharge basin head at discharge point

S_f = Suction (capillary) head at wetting front = .97 to 25.36 cm for sands

L = Depth to wetting front

For the pilot system, the suction head (S_f) will be zero as the system will be operated long enough for the wetting front to reach the ground water table, and the recharge basin head can be assumed to be zero as it will be small compared to the depth to groundwater. Therefore, under saturated conditions, the infiltration rate will be equal to the saturated conductivity of the soils. The hydraulic loading will be determined using the infiltration rate and the area of the infiltration basin.

6.1.3 Groundwater Mounding

The saturated soil conductivity represents the maximum infiltration rate that can be achieved under saturated conditions; however the actual infiltration rate to be used in the field will be chosen to limit the potential for significant groundwater mounding to occur. Mounding is of potential concern due to the operation of the pilot system in an area where the groundwater table is relatively shallow and horizontal hydraulic conductivities are high. Mounding inhibits vertical movement of liquids through the flushing zone and can lead to flushing liquids moving laterally before mixing with groundwater.

AQTESOLVE software and the Site capture zone groundwater model were used to estimate the extent of mounding, and the impact on the capture zone and potentiometric surface as a result of operation of the pilot system. Physical and hydraulic information gathered during the 2010 Capture Zone Evaluation Report (Northgate, 2010d) were used as inputs into the AQTESOLVE calculations and are presented along with other modeling input parameters in Appendix C.

The expected pilot system operating conditions were input into the Site capture zone groundwater model to determine the impact on the capture zone and potentiometric surface. As illustrated in Figure 5A, the results of the modeling indicate that mounding due to operation of the pilot system will have only marginal effects at the edges of the capture zone, and that COPCs mobilized by the flushing operation will be captured by the IWF. Figure 5B illustrates the operation of the pilot system under steady-state and constant flow rate conditions of both the IWF and the AWF and would take up to 4 years to achieve. The duration of the pilot test

would be the time necessary to flush a maximum of eight pore volumes, which is expected to be between two and eight months. ENVIRON notes that, given the limited time frame proposed for pilot system operation, the steady-state conditions predicted by the model are highly unlikely to occur in the field and are considered to represent a worst-case scenario for groundwater mounding. As is discussed further herein, piezometers will be installed to monitor mounding, and the pilot system will be sized and operated conservatively to develop an understanding of the effects of different flushing flow rates and limit the potential for mounding.

6.1.4 Potential Impacts to the GWETS

As discussed above, operation of the pilot system will accelerate leaching of constituents from soil to groundwater. If successful in the field, this process will increase the influent loading to the GWETS. The degree to which loading to the GWETS will be affected will depend on a number of factors, including the mass of perchlorate and other leachable COPCs in the soils of the proposed pilot system area, the rates at which perchlorate and other COPCs present in the soils may leach, and the attenuation of these constituents (e.g., retardation, dispersion and dilution) between the pilot system and the affected interceptor wells.

To estimate the potential effect of the pilot system on GWETS influent loading, ENVIRON conservatively estimated that approximately 92,000 pounds of perchlorate are present in the vadose zone of the area targeted for the pilot test. Using the results of the previous laboratory testing program (Prima, 2010), ENVIRON assumed that the entire mass of perchlorate in the pilot test area could be flushed after two pore volumes over a period of two weeks. ENVIRON notes that this assumption is likely to significantly overestimate the rate at which perchlorate will leach from soils in the pilot system due to the issues discussed in Section 2.0 above. Accordingly, we believe the resulting estimates of incremental loading to the GWETS described below to be worst-case conditions that are unlikely to be achieved in the field.

Perchlorate migration to the IWF wells was estimated using an analytical solution of the advection-dispersion equation, which predicts concentration as a function of time. Groundwater velocity was assumed to be one foot per day and dispersivity was assumed to be one tenth the distance between the pilot test area and the IWF extraction wells. ENVIRON also assumed that COPCs are not attenuated in groundwater due to biodegradation or retardation. Using these assumptions, ENVIRON estimated that the maximum additional perchlorate loading to the GWETS would be on the order of approximately 146 pounds per day. This equates to a maximum equivalent loading³ (accounting for the relative effects of nitrate and chlorate as well as perchlorate) of approximately 26 pounds per day which represents less than a 5% increase over the equivalent loading rates experienced by the GWETS in 2013 and less than 2% of the

³ Equivalent Load (lbs/day) = [(0.90 x NO3-N) + (0.17 x ClO3) + (0.18 x ClO4)] x Q x 1440 x 8.34 / 1,000,000

Where:

NO3-N = Nitrate-nitrogen concentration, (mg/L as N)

ClO3 = Chlorate concentration, (mg/L)

ClO4 = Perchlorate concentration, (mg/L)

Q = Influent flow (gpm)

(Shaw Environmental, Inc., 2006)

GWETS design equivalent load (1,800 pounds per day). Accordingly, the treatment system is not expected to be significantly impacted as a result of operation of the pilot system. Detailed calculations of the mass of perchlorate estimated to be flushed from the candidate pilot location and associated projections of perchlorate loading to the IWF are provided in Appendix D.

A refined evaluation of loading of both perchlorate and other COPCs will be performed based on the results of the column testing discussed under Section 5 above, and prior to the design of the pilot system. Additionally, wells installed to monitor the pilot system and nearby downgradient interceptor well I-AR will be sampled during the operation of the pilot system to monitor the concentration of perchlorate and loading to the GWETS. If necessary, the rate of soil flushing will be adjusted to ensure loading to the GWETS remains within operational limitations.

6.2 Flushing Liquid Delivery System Operation

The proposed pilot system will be installed and operated as a surface infiltration basin. Flushing liquid will be distributed to the subsurface by flooding the pilot area to create a uniform hydraulic head across each pilot cell.

Pending the results of the permeameter testing, the preliminary sizing of the pilot area is estimated to be approximately 100 feet by 100 feet. The area will be enclosed by an earthen berm with interior berms to divide the area into four 50 feet by 50 feet cells. This configuration will provide the flexibility to adjust the hydraulic loading to each pilot cell and will provide information to assess the pilot system's effect on subsurface flow conditions and groundwater mounding. This information will be collected and used in assessing the effectiveness, optimal design, and operation of a potential full-scale system.

The berms will be constructed from clean fill, compacted and graded with 3:1 side slopes with a 1 foot top-of-berm width. The pilot cell berms will be high enough to provide at least six inches of freeboard inside the berm. The entire pilot area will be covered with a vapor barrier (e.g., high-density polyethylene [HDPE] or similar liner) to limit evaporation losses.

If GWETS effluent water is selected as the flushing liquid for the pilot test, effluent water from the GWETS will be supplied by installation of a connection at the discharge from the final effluent tank. If Lake Mead water is used as the selected flushing liquid, then a connection will be made at the nearest supply line. In either case, the flushing liquid supply to the pilot cell will include a surge tank, check valve, a shutoff valve, a pump with controls, inline filter, air vents to drain the lines during shutdown, a pressure indicator, a flow meter with data logger, and flow control valve for each infiltration cell. The supply line will branch and discharge into each of the pilot cells; rip-rap or a similar velocity dissipation device will be installed around the discharge point to slow flow of liquid and prevent erosion.

Flow into the pilot area will be controlled as follows. To prevent overflow of the berms of the pilot cell, a float switch or similar control device will be installed that will automatically secure flow into the pilot cell if a high level set point is reached, and will reinitiate flow once a low level set point is reached. To control the degree of mounding above the groundwater table, a control device will be installed to turn off flow based on the water level measured by an in-well transducer installed in one of the piezometers used to monitor the pilot cell. To provide flexibility

in operations (e.g., pulsed application), the pilot system will be configured with a timer on the flushing fluid supply from the surge tank. A flow diagram for the pilot system is provided in Figure 8. The exact equipment, specifications, and layout will be provided in the pilot design document.

During construction of the pilot system, dust control and monitoring will be conducted to limit fugitive dust generation. Air monitoring will be performed by on-site personnel during construction using personal DataRAM devices programmed to measure the sixty-second average of real-time dust concentrations. Readings of upwind and downwind concentrations will be taken approximately once every hour and recorded in a daily logbook. If the difference between the upwind and downwind reading exceeds 100 microgram per cubic meter, on-site personnel will implement dust control measures consisting of wetting the ground surface in the construction area.

6.3 Permitting

The currently proposed pilot system would involve the application of flushing liquid at the ground surface. Pursuant to Nevada Revised Statute (NRS) 445A.485 a temporary Groundwater Discharge Permit application will be filed with the NDEP Bureau of Water Pollution Control. The Nevada statutes stipulate that such temporary permits may be issued for a maximum of a 180 day (6 month) period of time, which is within the likely duration of the pilot test. Extension of the test for a longer time period will require application for a new temporary Groundwater Discharge Permit at least 30 days prior to expiration of the “existing” temporary Groundwater Discharge Permit.

The application for a temporary groundwater discharge permit requires the following information to be provided:

1. A narrative description of the Site and activities that require the discharge permit;
2. Results of water quality analysis by a Nevada State Certified Lab to include the potential contaminants/pollutants in the discharge;
3. The estimated quantity of discharge flow (e.g., gallons per day);
4. A topographic map and a map of the Site showing the location of the potential discharge and a line drawing showing the general route taken by water in the facility from intake to discharge; and
5. A listing of existing environmental permits at the facility.

In addition to the temporary groundwater discharge permit, the proposed pilot system would also involve the disturbance of soils over an area of approximately 0.25 acres. Pursuant to Clark County Air Quality Regulations Section 94, an application for a Dust Control Permit will be filed with Clark County Division of Air Quality. Such a permit would be valid for one calendar year. The application for a Dust Control Permit requires the following:

1. Creation of a "Dust Mitigation Plan," which consists of completing a provided checklist outlining the planned activities with a potential to generate fugitive dust and selecting a best management practice for dust control during each activity; and
2. A map of the Site showing the location of the planned activities.

7 Pilot System Monitoring

7.1 Leachate Monitoring

Pore water samples will be collected during the pilot test period to assess mass removal, to assess the number of pore volumes required to flush Site vadose zone soils, and to establish a correlation between leachate and soil perchlorate concentrations in order to streamline full-scale system monitoring. Pore water samples will be collected using the 1920F1 Pressure/Vacuum Soil Water Sampler. Four pore water monitoring nests will be installed in the permeameter test borings within the pilot system footprint at the locations shown in Figure 9.

Each nest will consist of three lysimeters installed to depths of approximately 6, 12 and 20 feet bgs. If caliche is encountered at a pore water monitoring location, then the installation depths of the lysimeters may be adjusted so that lysimeters are situated above and below the caliche to help determine the effects of this material on the performance of the pilot system. Each lysimeter will be installed in its own, separate boring spaced approximately two feet apart; PVC casing will be installed from the lysimeter to the ground surface to protect the sampler and tubing.

Pore water samples will be obtained from the four newly installed lysimeter nests using methods and instruments provided for in Soil Moisture Equipment Corp's *1921F1/1920F1K1 Operating Instructions* (Appendix B). The amount of pore water collected will vary according to conductivity of the soil, suction within the soil, and amount of vacuum within the sampler. Pore water will be collected once the soil becomes saturated and every other day thereafter. After completion of the pilot test, pore water samples will continue to be collected bi-weekly for two weeks.

Pore water samples will be analyzed for the parameters listed in Table 2, following the sampling procedures in Appendix B. The analytes are listed by priority in the case that the total volume of pore water in the sampler is less than the total volume of pore water needed for analysis. As stated in Section 1.2 above, the results of leachate monitoring will be used to assess the performance of the pilot system to reduce the mass of perchlorate in soils.

7.2 Soil

Soil samples will be collected before and after the pilot test to assess the change in vadose zone soil perchlorate concentrations. Soil samples will be collected at 0, 5, 10, 15 and 20 feet bgs from the same boring used to install the 20 foot pore water monitoring point in each quadrant of the pilot area. Post-pilot test soil samples will be collected from borings installed immediately adjacent to the pre-pilot test borings approximately two weeks after cessation of soil flushing or once all lysimeters are no longer collecting leachate from the subsurface. Samples will be analyzed for the constituents listed in Table 2. Soil cuttings will be described in the field and sampled by an experienced ENVIRON field geologist following the procedures in Appendix B.

As indicated above, the results of lysimeter sampling will be used as the key parameter to assess the performance of the pilot system. Due to potential variability in subsurface conditions (e.g., anisotropies), the discrete nature of soil sampling and difficulties in reproducing results,

the results of soil sampling are not proposed as a strict indicator of performance for the pilot system, but rather as an additional line of evidence supporting the assessment of pilot system effectiveness.

7.3 Groundwater Monitoring

Groundwater monitoring will be conducted to assess the influence of soil flushing on groundwater quality and the rate of application of flushing liquid on groundwater mounding. Four new groundwater monitoring wells – three downgradient and one upgradient – will be installed to monitor changes in groundwater quality (see Figure 9). Monitoring wells will be constructed of 2-inch inner diameter schedule 40 PVC with 10 feet of 0.01" slot screen. Well screens will be positioned to straddle the water table; a well installation summary is provided Table 3. Groundwater samples will be collected before and after pilot system operation and weekly or bi-weekly during pilot system operation; this proposed frequency may be modified based on the results of the pore water samples. The parameters and associated analytical methods are provided in Table 1, and groundwater sampling procedures are provided in Appendix B.

Additionally, groundwater elevations will be monitored at five locations adjacent to and downgradient of the pilot location (see Figure 9) to assess the extent of groundwater mounding and the potential for lateral migration of groundwater induced by the pilot system. As discussed in Section 3, the groundwater table in the area of the pilot test is expressed at about 20 feet bgs within the UMCf formation. Previous investigations of the Site have indicated that the hydraulic conductivity of the UMCf is significantly less than the overlying alluvium within the Qal. Depending on the rate of application of flushing liquid during the pilot test, mounding of groundwater within the Qal, and an increase in potentiometric head expressed within the UMCf could occur. To monitor these conditions both a shallow piezometer, screened within the alluvium just above the Qal-UMCf interface, and a deep piezometer, screened within the UMCf just below the Qal-UMCf interface, will be installed at each location.

Piezometers will be nested within the same boring at each location, and constructed of 1-inch inner diameter schedule 40 PVC with 10 feet of 0.01" slot screen, except as noted below; a well installation summary is provided in Table 3. Water levels at the first downstream piezometer nest will be monitored every hour using transducers with on-board data logging. As discussed in Section 5, the transducers will act as a control for the pilot system, shutting off water flow if water levels exceed the set point. Water levels at the other piezometers will be measured daily during pilot system operation; results will be recorded in a field note book and kept at the Site. Monitoring wells and piezometers will be installed following the procedures in Appendix B.

In addition to the chemical constituent monitoring, biological monitoring will also be conducted during the pilot test if significant perchlorate reduction is observed during the column tests. Biological monitoring will be accomplished by deploying biostimulation In-situ Microcosm (ISM) samplers in wells M-2 and P-1C; these wells will be constructed of 2-inch inner diameter schedule 40 PVC with 10 feet of 0.01" slot screen. The ISM units will contain a sampler for COPCs, a Bio-Trap[®] (MICRO) sampler and a geochemistry sampler for evaluation of perchlorate and perchlorate byproducts, electron acceptors, nutrients and microbial populations. Groundwater samples from the ISMs will be collected before and after pilot system operation,

and weekly or bi-weekly during pilot system operation; this proposed frequency may be modified based on the results of the pore water samples. The parameters and associated analytical methods are provided in Table 1, and groundwater sampling procedures are provided in Appendix B.

8 Reporting

A report detailing the results of the preliminary field and laboratory testing as discussed in Section 5 and a final design for installation of the pilot system will be submitted 30 days after completion of laboratory work. The report will include a description of the field and laboratory activities, a discussion of modifications or deviations from the Work Plan, results of the fieldwork and the final design of the pilot test with drawings and specifications, and an implementation schedule.

9 Schedule

A preliminary schedule for the in-situ soil flushing treatability study is presented in Figure 10. The timing of events presented in Figure 10 is based on months from the date of submission of this Work Plan to the NDEP. Following receipt of NDEP approval of this Work Plan, an updated schedule that provides specific dates will be submitted to NDEP within the RI Cost Documentation to be submitted in July.

10 References

- ENVIRON 2013. Annual Remedial Performance Report for Chromium and Perchlorate, NERT Site, Henderson, Nevada, July 2012 – June 2013. August 30.
- ENVIRON 2012a. Interim Soil Removal Action Completion Report, August 2010 – November 2011. January
- ENVIRON 2012b. Semi-Annual Remedial Performance Report for Chromium and Perchlorate, NERT Site, Henderson, Nevada, July 2011 – December 2011. February 29.
- ENVIRON 2012c. Revised April 2012 with May 2012 errata, Summary of Excavation Control Areas (ECAs): Areas of Known Soil Contamination left In-Place and Uncharacterized Potentially Contaminated Soils. December.
- ENVIRON 2012d. Revised April 2012 with May 2012 errata, Site Management Plan (SMP). December.
- Glass, R.J., Nicholl, M.J. Physics of gravity fingering of immiscible fluids within porous media: An overview of current understanding and selected complicating factors. *Geoderma*, 70 (1996): 133-163.
- Green, W. H., and G. A. Ampt 1911. Studies on soil physics, *J. Agric. Sci.*, 4(1), 1 –24.
- NDEP (Nevada Department of Environmental Protection) 2011. Groundwater Discharge Permit (Permit No. 2001515), Authorization to Discharge, Issued to Nevada Environmental Response Trust. July 10.
- Northgate (Northgate Environmental Management, Inc.) 2010a. Work Plan to Evaluate In-Situ Soil Flushing of Perchlorate-Impacted Soil. March 29. Revised May 27 and November 12.
- Northgate 2010b. Hydrogeologic Modeling Work Plan. April 29.
- Prima (Prima Environmental Inc) 2010. Report of Findings Column Tests to Evaluate In-Situ Flushing of Perchlorate. October 4.
- Northgate 2010c. Revised Work Plan to Evaluate In-Situ Soil Flushing of Perchlorate-Impacted Soil. November 12.
- Northgate 2010d. Capture Zone Evaluation Report. December 10.
- Shaw Environmental, Inc. (Shaw) 2006. Tronox, LLC Fluidized Bed Perchlorate Treatment System with Upgrades, Design Drawings. September 20.

Tables

TABLE 1
Water Sample Analytes and Methods
Treatability Study Work Plan,
In-Situ Soil Flushing

Analyte	Volume (mL)	USEPA Method	Frequency ¹	Priority ²
Lysimeters				
Perchlorate	125	314	Start-up and Bi-weekly	1
Conductivity, DO, pH, ORP	50	Portable Instrument		2
TDS	125	160.1		3
Dissolved Metals (Ag, As, B, Ba, Be, Ca, Cd, Cr, Co, Cu, Fe, Hg, K, Mo, Mg, Mn, Na, Ni, Pb, Sb, Se, Ti, Zn)	100	6010/6020/7400		4
Cr(VI)	50	7199		5
DOC	80	9060	Start-up and Weekly during pilot operation	6
Anions (Cl, ClO ₃ , F, NO ₃ , NO ₂ , SO ₄)	125	9056		7
Ammonia	500	350.1		8
Phosphate	125	365.1		9
Sulfite	500	377.1		10
Ferrous Iron (Fe+2)	100	Field Kit		11
Alkalinity (Total, HCO ₃ , Hydroxide)	500	310.2		12
Hardness (total)	250	130.1		13
Dissolved Metals (U)	100	200.8		14
Chloroform (VOCs)	120	8260B	Start-up	15
Organochlorine Pesticides + Hexchlorobenzene	250	8081A		16
Monitoring Wells				
Perchlorate	125	314	Start-up and Bi-weekly	1
Conductivity, DO, pH, ORP	50	Portable Instrument		2
TDS	125	160.1		3
Dissolved Metals (Ag, As, B, Ba, Be, Ca, Cd, Cr, Co, Cu, Fe, Hg, K, Mo, Mg, Mn, Na, Ni, Pb, Sb, Se, Ti, Zn)	100	6010/6020/7400		4
Cr(VI)	50	7199		5
DOC	80	9060	Start-up and Weekly during pilot operation	6
Anions (Cl, ClO ₃ , F, NO ₃ , NO ₂ , SO ₄)	125	9056		7
Ammonia	500	350.1		8
Phosphate	125	365.1		9
Phospholipid fatty acid (PLFA) ³	Biosep beads	MI SOP ⁴		10
Perchlorate reductase gene ³	Biosep beads	MI SOP ⁵		11
Sulfite	500	377.1		12
Ferrous Iron (Fe+2)	100	Field Kit		13
Alkalinity (Total, HCO ₃ , Hydroxide)	500	310.2		14
Hardness (total)	250	130.1		15
Dissolved Metals (U)	100	200.8		16
Chloroform (VOCs)	120	8260B	Start-up	17
Organochlorine Pesticides + Hexchlorobenzene	250	8081A		18

Notes:

1. If constituents are repeatedly not detected, then the frequency of analysis may be reduced.
2. All analytes to be run if sufficient sample volume is available. Priorities apply only in the event that insufficient volume is available to run all analyses.
3. Only required in wells containing Biotraps
4. MI SOP= Microbial Insights Standard Operating Procedure for microbial testing
5. Nozawa-Inoue M, Jien M, Hamilton NS, Stewart V, Scow KM, Hristova KR. Quantitative Detection of Perchlorate-Reducing Bacteria by Real-Time PCR Targeting the Perchlorate Reductase Gene. Appl. Environ. Microbiol. 2008; 74(6): 1941-1944.

TABLE 2
Soil Sample Analytes and Methods
Treatability Study Work Plan,
In-Situ Soil Flushing

Analyte	USEPA Method
Hexavalent Chromium, Cr(VI)	7190A/7199/3060A
Metals	6010/6020
Perchlorate	314/6850
pH	9045
Phospholipid fatty acid (PLFA)	MI SOP ¹
Perchlorate reductase gene	MI SOP ²

Notes:

1. MI SOP= Microbial Insights Standard Operating Procedure for microbial testi
2. Nozawa-Inoue M, Jien M, Hamilton NS, Stewart V, Scow KM, Hristova KR. Quantitative Detection of Perchlorate-Reducing Bacteria by Real-Time PCR Targeting the Perchlorate Reductase Gene. Appl. Environ. Microbiol. 2008; 74(6): 1941-1944.

TABLE 3
List of Planned Groundwater Monitoring Wells and Piezometers
Treatability Study Work Plan
In-Situ Soil Flushing

Well ID	Type	Material	Diameter	Screened Interval (ft bgs)	Screen Length	Screen Slot Size	Screened Formation
SF-M-1	Monitoring	PVC	2 inch	20-30	10 feet	0.01 inch	UMCf
SF-M-2 ¹	Monitoring	PVC	2 inch	15-25	10 feet	0.01 inch	Qal/UMCf
SF-M-3	Monitoring	PVC	2 inch	22-32	10 feet	0.01 inch	Qal/UMCf
SF-M-4	Monitoring	PVC	2 inch	22-32	10 feet	0.01 inch	Qal/UMCf
SF-P-1A	Piezometer	PVC	1 inch	15-20	5 feet	0.01 inch	Qal
SF-P-1B	Piezometer	PVC	1 inch	20-25	5 feet	0.01 inch	UMCf
SF-P-1C ²	Monitoring	PVC	2 inch	15-25	10 feet	0.01 inch	Qal/UMCf
SF-P-2A	Piezometer	PVC	1 inch	15-20	5 feet	0.01 inch	Qal
SF-P-2B	Piezometer	PVC	1 inch	20-25	5 feet	0.01 inch	UMCf
SF-P-3A	Piezometer	PVC	1 inch	25-30	5 feet	0.01 inch	Qal
SF-P-3B	Piezometer	PVC	1 inch	30-35	5 feet	0.01 inch	UMCf
SF-P-4A	Piezometer	PVC	1 inch	25-30	5 feet	0.01 inch	Qal
SF-P-4B	Piezometer	PVC	1 inch	30-35	5 feet	0.01 inch	UMCf
SF-P-5A	Piezometer	PVC	1 inch	22-27	5 feet	0.01 inch	Qal
SF-P-5B	Piezometer	PVC	1 inch	27-32	5 feet	0.01 inch	UMCf

Notes:

1. SF-M-2 will contain an ISM if biological monitoring is conducted.
2. SF-P-1C will contain an ISM and will only be installed if biological monitoring is conducted.

Figures

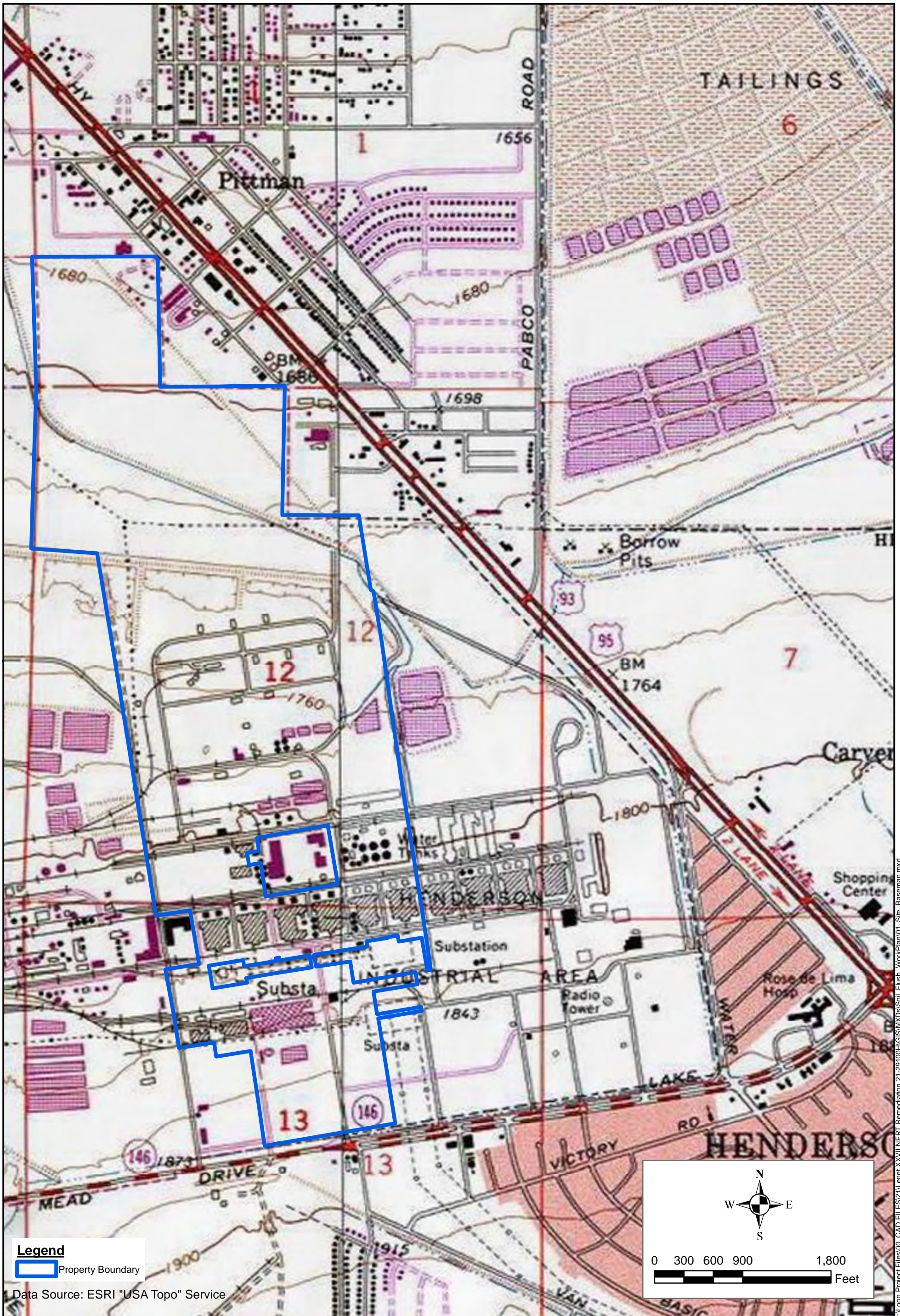

Legend
 Property Boundary

Data Source: ESRI "USA Topo" Service

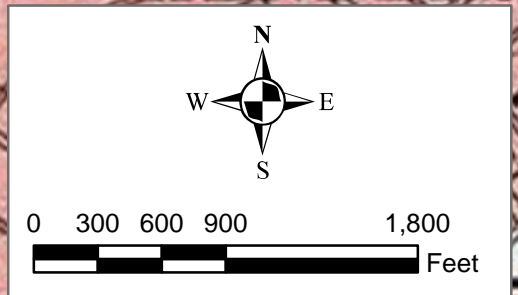

SITE LOCATION MAP

Nevada Environmental Response Trust Site, Henderson, Nevada

Figure

1

L:\loop Project Files\00_CAD FILES\21\Leper\XXVII\NERI Remediation 21-29100\GIS\MXDS\Soil_Flush_WorkPlan01_Site_BaseMap.mxd



Legend

- Proposed Pilot Test Location
- Site Boundary
- Barrier Wall

Data Sources: ESRI 2010 Bing Imagery
 Projection: State Plane Coordinate System of 1983, Nevada East Zone

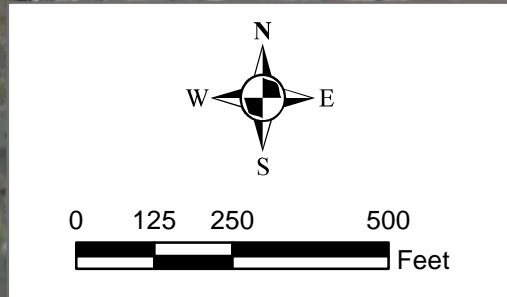

PROPOSED PILOT TEST LOCATION

Nevada Environmental Response Trust Site, Henderson, Nevada

Drafter: CCS

Date: 12/7/2012

Contract Number: 21-29100H

Approved by: BSK/KKG

Revised:

Figure

2

L:\Loop Project Files\00_CAD FILES\21\Leper XXVII NERT Remediation 21-29100H\GIS\MXD\Soil_Flush_WorkPlan\02_Proposed_Pilot_Test_Loc.mxd



Perchlorate Concentrations at the Proposed Pilot Test Location
 Nevada Environmental Response Trust Site, Henderson, Nevada

Figure 3

Drafter: EA

Date: 12/7/2012

Contract Number: 21-29100

Approved by: BSK/KKG

Revised:



L:\Loop Project Files\00_CAD FILES\21\Leper_XXVII NERT Remediation_21-29100H\GIS\MXDs\Soil_Flush_WorkPlan04_UtillitiesNearPilotTestSite.mxd



UTILITIES NEAR THE PROPOSED PILOT TEST LOCATION

Nevada Environmental Response Trust Site, Henderson, Nevada

Drafter: CCS

Date: 12/7/2012

Contract Number: 21-29100H

Approved by: BSK/KKG

Revised:

Figure

4

Path: H:\LePetomane\NERT\Modelling\NERT_Updated_2012\Pilot Testing -soil Flushing\Figure X -IWF Pilot Testing.mxd

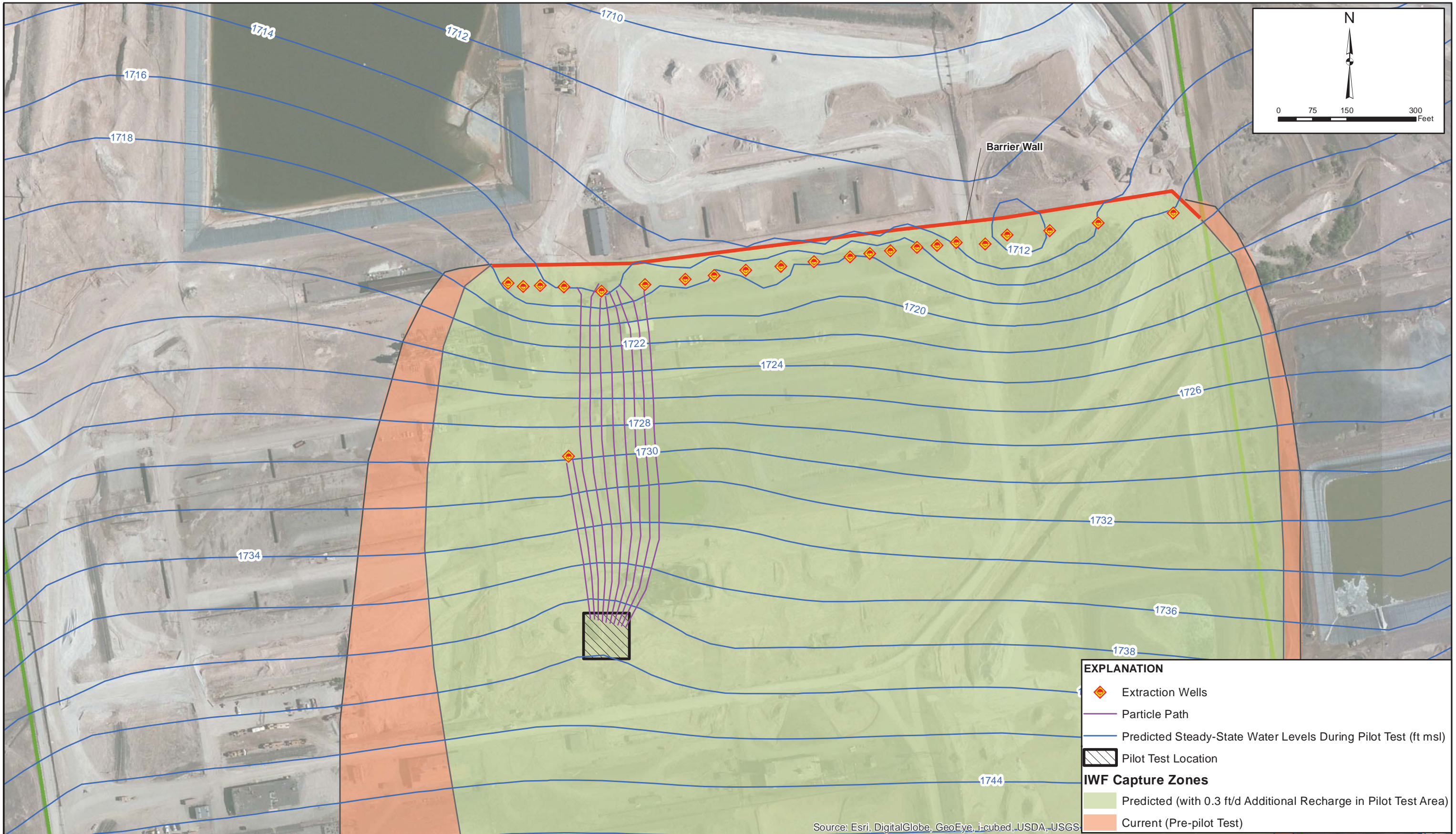

EXPLANATION

- Extraction Wells
- Particle Path
- Predicted Steady-State Water Levels During Pilot Test (ft msl)
- Pilot Test Location

IWF Capture Zones

- Predicted (with 0.3 ft/d Additional Recharge in Pilot Test Area)
- Current (Pre-pilot Test)

Source: Esri, DigitalGlobe, GeoEye, i-cubed, USDA, USGS



2200 Powell St., Suite 700, Emeryville, CA 94608

Predicted Mounding and Capture Zone During Soil Flushing Pilot Test

Nevada Environmental Response Trust Site
Henderson, Nevada

Figure
5A

Drafter: AS

Date: 11/18/2013

Contract Number: 21-291001

Approved by: CS

Revised: AS

Path: H:\LePetomane\NERT\Modelling\NERT_Updated_2012\Pilot_Testing - Soil Flushing\Figure 2 - IWF Pilot Testing - Soil Flushing_IWF_Capture_Zone_Pie-Pilot_Test.mxd

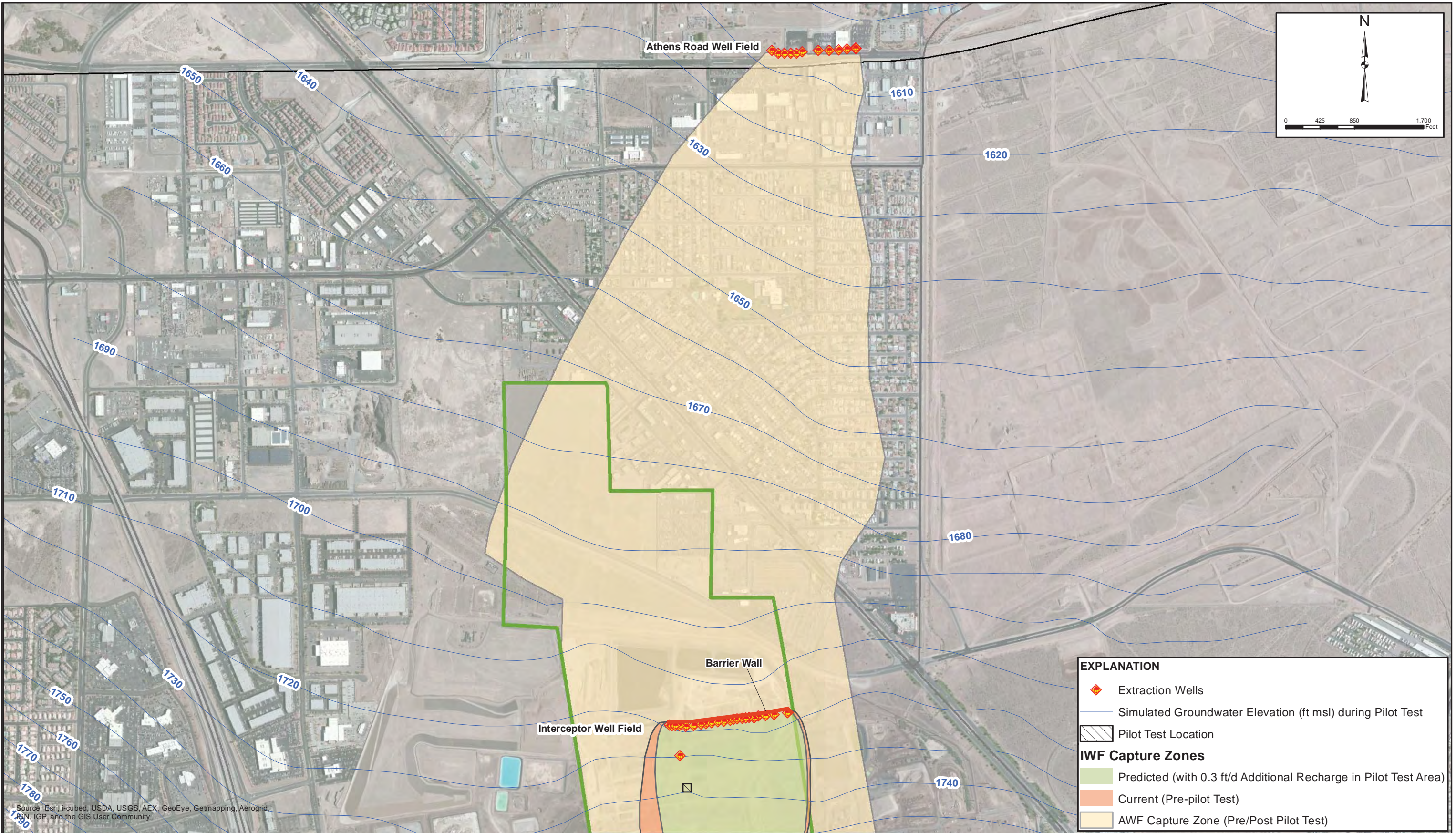

Source: Esri, i-cubed, USDA, USGS, AEX, GeoEye, Getmapping, Aerogrid, IGN, ICP, and the GIS User Community

EXPLANATION

- Extraction Wells
- Simulated Groundwater Elevation (ft msl) during Pilot Test
- Pilot Test Location

IWF Capture Zones

- Predicted (with 0.3 ft/d Additional Recharge in Pilot Test Area)
- Current (Pre-pilot Test)
- AWF Capture Zone (Pre/Post Pilot Test)



Predicted Capture Zone - Soil Flushing Pilot Test
 Nevada Environmental Response Trust Site
 Henderson, Nevada

Figure
5B

Drafter: AS Date: 11/14/2013 Contract Number: 21-291001 Approved by: CS Revised: AS

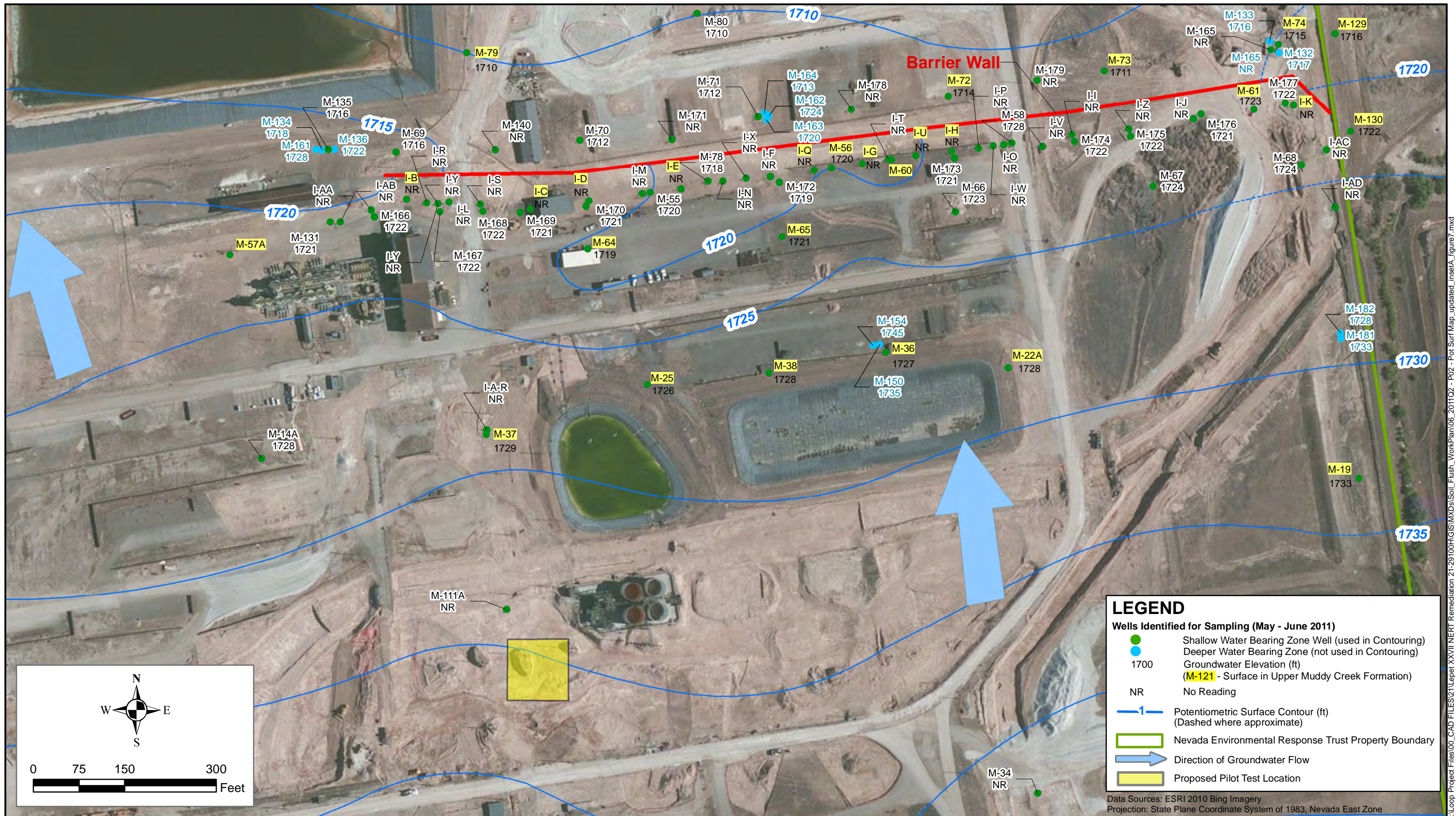

LEGEND

- Shallow Water Bearing Zone Well (used in Contouring)
- Deeper Water Bearing Zone (not used in Contouring)
- 1700 Groundwater Elevation (ft)
- (M-121) - Surface in Upper Muddy Creek Formation
- NR No Reading
- Potentiometric Surface Contour (ft) (Dashed where approximate)
- ▭ Nevada Environmental Response Trust Property Boundary
- ➔ Direction of Groundwater Flow
- ▭ Proposed Pilot Test Location

Data Sources: ESRI 2010 Bing Imagery
 Projection: State Plane Coordinate System of 1983, Nevada East Zone

GROUNDWATER POTENTIOMETRIC SURFACE NEAR THE PROPOSED PILOT TEST LOCATION
 Nevada Environmental Response Trust Site, Henderson, Nevada

Drafter: MI Date: 12/7/2012 Contract Number: 21-29100H Approved by: BSK/KKG Revised:

Figure **6**



L:\Loop Project Files\00_CAD FILES\21\Leper XXVII NERT Remediation 21-29100H\GIS\MapDocs\Soil_Flush_WorkPlan\06_2011\02 - P02 - Pot Surf Map_updated_insetA_figure7.mxd



L:\Loop Project Files\00_CAD FILES\21\Leper_XXVII NERT Remediation 21-29100H\GIS\MXDs\Soil_Flush_WorkPlan\07_2011\02 - P07 - Perchlorate_v2_insetA_figure8.mxd



PERCHLORATE CONCENTRATIONS IN GROUNDWATER NEAR THE PROPOSED PILOT TEST LOCATION
Nevada Environmental Response Trust Site, Henderson, Nevada

Figure
7

Drafter: MI

Date: 12/7/2012

Contract Number: 21-29100H

Approved by: BSK/KKG

Revised:

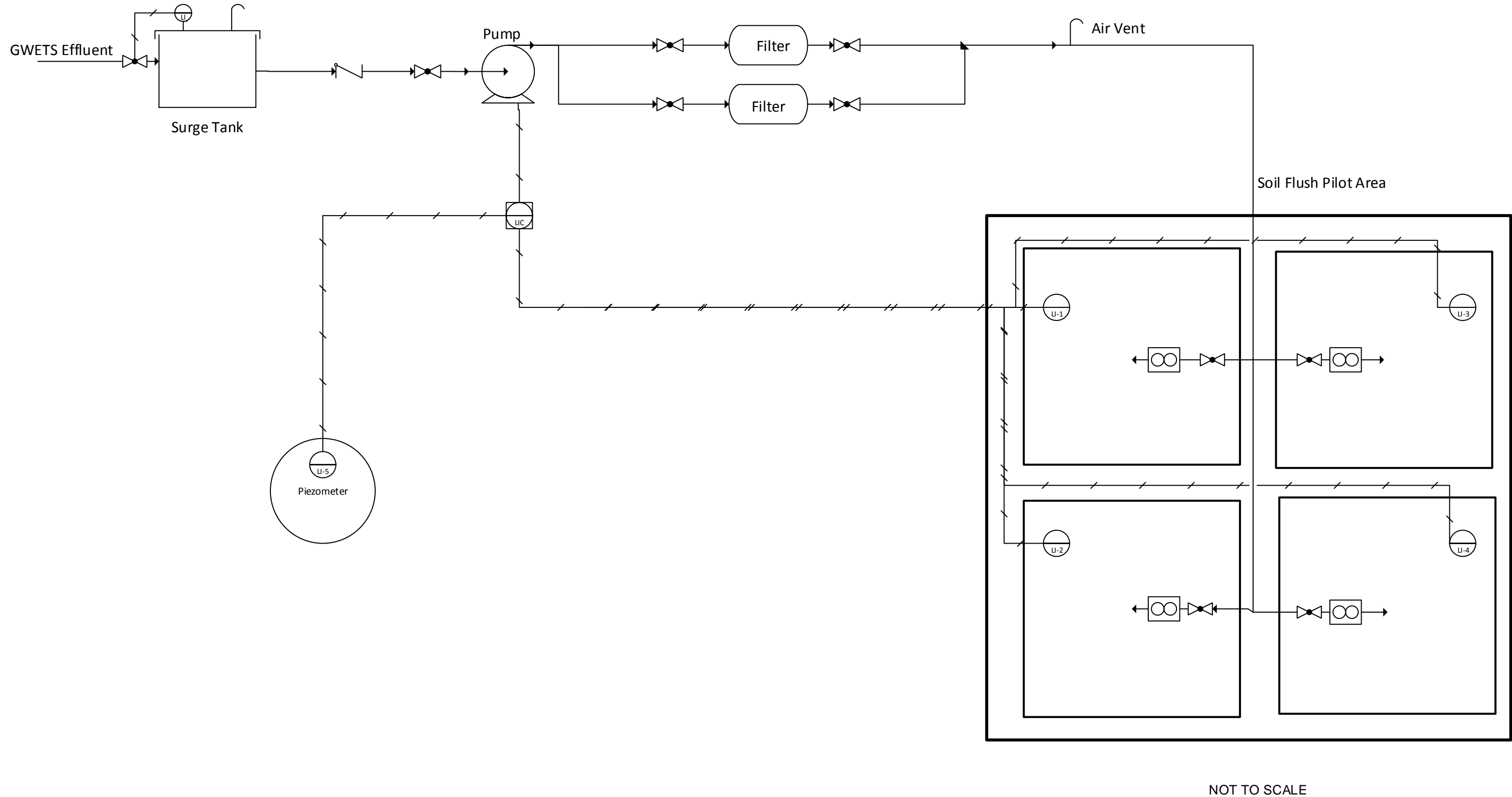

PROPOSED SOIL FLUSH PILOT TEST PROCESS FLOW LAYOUT
 Nevada Environmental Response Trust Site, Henderson, Nevada

Drafter: FN

Date: 12/7/2012

Contract Number: 21-29100H

Approved by: BSK/KKG

Figure
8

L:\Loop Project Files\00_CAD FILES\21\Lepe\21\NERT Remediation 21-29100H\Isol\08_NERT Soil Flush.vsd



PILOT TEST MONITORING LAYOUT - SOIL FLUSHING TREATABILITY STUDY

Nevada Environmental Response Trust Site, Henderson, Nevada

Drafter: CCS

Date: 12/7/2012

Contract Number: 21-29100H

Approved by: BSK/KKG

Revised:

Figure

9

L:\Loop Project Files\00_CAD FILES\21\Leper XXVII NERT Remediation 21-29100H\GIS\MXDs\Soil_Flush_WorkPlan\09_PilotTestMonitoringLayout_r3.mxd

Figure 10. Preliminary Time Schedule for In-situ Soil Flushing Treatability Study

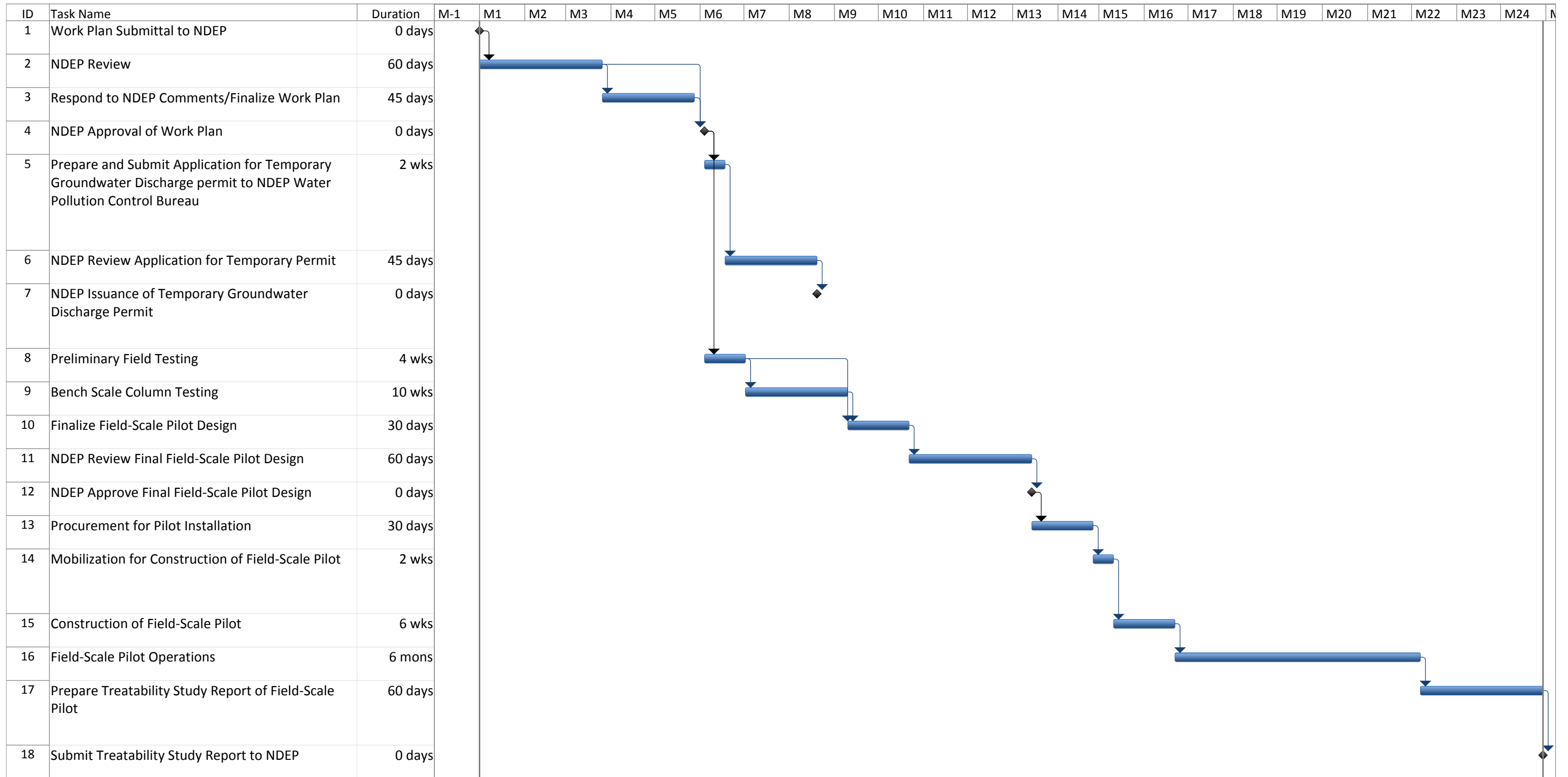

Task		Project Summary		Inactive Milestone		Manual Summary Rollup		Deadline	
Split		External Tasks		Inactive Summary		Manual Summary		Progress	
Milestone		External Milestone		Manual Task		Start-only			
Summary		Inactive Task		Duration-only		Finish-only			

Appendix A

Boring Logs and Well Construction Diagrams

SOIL BORING LOG KM-5055A

KERR-McGEE CORPORATION Hydrology Dept. Engineering Services		KM SUBSIDIARY KMCLLC	LOCATION HENDERSON, NV		BORING NUMBER M-14A					
DEPTH IN FEET	LITHOLOGIC DESCRIPTION	GRAPHIC LOG	UNIFIED SOIL FIELD CLASS.	BLOWS PER FOOT	PID (PPM)	SOIL SAMPLE				REMARKS OR FIELD OBSERVATIONS
						NO.	TYPE	DEPTH	REC.	
0-20	SAND, gravelly w/ 10-20% silt, brn. 50% v.f. vc sand, 5-8 SA 30-40% volc gravel to 1" diam 10-20% silt		SW/SM							
20-28	SAND, silty, brn. 30-40% silt in v.f. mg sand matrix		SM/ML							Jump @ 23 wt @ 28
28-40	CLAY, silty brn. 30-40% silt in clay matrix		CL							MC @ 28'

EXPLANATION	Water Table (24 Hour)	GRAPHIC LOG LEGEND		DATE DRILLED	PAGE
	Water Table (Time of Boring)	CLAY	DEBRIS FILL	12-7-04	1 of 1
	PID	SILT	HIGH ORGANIC PEAT	DRILLING METHOD	
	NO.	SAND	SANDY CLAY	HSA	
	TYPE	GRAVEL	CLAYEY SAND	DRILLED BY	TENV
SPLIT-BARREL	AUGER	SILTY CLAY	LOGGED BY	Ed KRISH	
THIN-WALLED TUBE	CONTINUOUS SAMPLER	CLAYEY SILT	EXISTING GRADE ELEVATION (FT. AMSL)	1758.30	
ROCK CORE	NO RECOVERY		LOCATION OR GRID COORDINATES		
DEPTH	Depth Top and Bottom of Sample				
REC.	Actual Length of Recovered Sample in Feet				

**KERR-McGEE CORPORATION
HYDROLOGY DEPARTMENT
MONITORING WELL INSTALLATION DIAGRAM**

Protective Pipe
 Yes No
 Steel PVC
 Surveying Pin? Yes No

Casing Cap Vent? Yes No
Lock? Yes No
Weep Hole? Yes No

Concrete Pad 1 Ft. x 1 Ft. x 4 Inches

DEPTH FROM TOP OF CASING

Concrete 7 Ft.

Cement/Bentonite Grout Mix
 Yes No
 5.5 Gallons Water to 94Lb. Bag Cement & 3-5 Lb. Bentonite Powder.
 Other: CONCRETE

Bentonite Seal
 Pellets Slurry

Filter Pack Above Screen 10 Ft.

FILTER PACK MATERIAL
 Silica Sand
 Washed Sand
 Pea Gravel
 Other: _____

Sand-Size 8-12

Dease Phase Sampling Cup
 Bottom Plug Yes No
 Overdrilled Material Backfill
 Grout Sand
 Caved Material
 Other: _____

7
10
20
40
40.2

DRILLING INFORMATION:
 1. Borehole Diameter = 8 Inches.
 2. Were Drilling Additives Used? Yes No
 Revert Bentonite Water
 Solid Auger Hollow Stem Auger
 3. Was Outer Steel Casing Used? Yes No
 Depth: _____ Feet.
 4. Borehole Diameter for Outer Casing _____ Inches.

WELL CONSTRUCTION INFORMATION:
 1. Type of Casing: PVC Galvanized Teflon
 Stainless Other _____
 2. Type of Casing Joints: Screw-Couple Glue-Couple Other _____
 3. Type of Well Screens: PVC Galvanized
 Stainless Teflon Other _____
 4. Diameter of Casing and Well Screens:
 Casing 2 Inches, Screen 2 Inches.
 5. Slot Size of Screens: 0.020
 6. Type of Screen Perforation: Factory Slotted
 Hacksaw Drilled Other _____
 7. Installed Protector Pipe w/locks: Yes No

WELL DEVELOPMENT INFORMATION:
 1. How was Well Developed? Bailing Pumping
 Air Surging (Air or Nitrogen) Other SURGE BLOCK / AIR LIFT
 2. Time Spent on Well Development? 4 Minutes/Hours
 3. Approximate Water Volume Removed? 75 Gallons
 4. Water Clarity Before Development? Clear
 Turbid Opaque
 5. Water Clarity After Development? Clear
 Turbid Opaque
 6. Did Water have Odor? Yes No
 If Yes, Describe _____
 7. Did Water have any Color? Yes No
 If Yes, Describe _____

WATER LEVEL INFORMATION:
 Water Level Summary (From Top of Casing)
 During Drilling 28 Ft. Date 12-7-04
 Before Development _____ Ft. Date _____
 After Development: 28.50 Ft. Date 12-7-04

Driller/Firm TENV Drill Rig Type Mobile B-61 Date Installed 12-7-04
 Drill Crew SHIM/KENT/RICK Well No. M-14A
 Hydrologist ED KRISH (ENSR)

901
02
101
W
K
W
68
ris
ere
Se
5
ion.
sing
ng
de
tes
10,
rio
ut
tes

SOIL BORING LOG KM-5655-8

KERR-McGEE CORPORATION Hydrology Dept. - S&EA Division		KM SUBSIDIARY KACELLE		LOCATION HENDERSON, NV		BORING NUMBER M17A					
DEPTH IN FEET	LITHOLOGIC DESCRIPTION	GRAPHIC LOG	UNIFIED SOIL FIELD CLASS.	BLOWS PER 6'	PID (ppm)	SOIL SAMPLE				REMARKS OR FIELD OBSERVATIONS	
						NO.	TYPE	DEPTH	REC.		
5	0-5 in. 3-4 mm SAND 15-20% silt 20- 25% clay 10-15% m-vc sand 10-15% m-vc clay										
10											
15											
20											
25	20-33 silty sdy GRAVEL, brown, 20% silt, 20% m-vc sand 10-15% m-vc clay										
30											
33											
35	33-35 silty clay silt 10-15% clay, 10-15% clay 15-20% m-vc sand									damp @ 33 wet @ 35	
37	35-37 coarse frak sdy GRAVEL, hard, 80% gravel 20% m-vc sd.										
EXPLANATION ▼ Water Table (24 Hour) ▽ Water Table (Time of Boring) PID Photoionization Detection (ppm) NO. Identifies Sample by Number TYPE Sample Collection Method ⊗ SPLIT-BARREL ▭ THIN-WALLED TUBE ▭ AUGER ▭ CONTINUOUS SAMPLER ▭ ROCK CORE ▭ NO RECOVERY DEPTH Depth Top and Bottom of Sample REC. Actual Length of Recovered Sample in Feet						GRAPHIC LOG LEGEND [diagonal lines] CLAY [horizontal lines] SILT [dots] SAND [cross-hatch] GRAVEL [diagonal lines /] SILTY CLAY [diagonal lines \] CLAYEY SILT [stippled] DEBRIS FILL [wavy] HIGHLY ORGANIC (PEAT) [diagonal lines /] SANDY CLAY [diagonal lines \] CLAYEY SAND				DATE DRILLED 6-15-03 PAGE 1 of 2	
						DRILLING METHOD HSA					
						DRILLED BY GUYE DRILLING					
						LOGGED BY GUYE					
						EXISTING GRADE ELEVATION (FT AMSL) 1708.95					
						LOCATION OR GRID COORDINATES 1758.95					

SOIL BORING LOG KM-5655-B

KERR-McGEE CORPORATION Hydrology Dept. - S&EA Division		KM SUBSIDIARY <i>KMCLLC</i>		LOCATION <i>HENDERSON, NV</i>			BORING NUMBER <i>M17A</i>				
DEPTH IN FEET	LITHOLOGIC DESCRIPTION	GRAPHIC LOG	UNIFIED SOIL FIELD CLASS.	BLOWS PER 6'	PID (ppm)	SOIL SAMPLE				REMARKS OR FIELD OBSERVATIONS	
						NO.	TYPE	DEPTH	REC.		
0-4 4-8 8-12 12-16 16-20 20-24 24-28 28-32 32-36 36-40 40-44 44-48 48-52 52-56 56-60 60-64 64-68 68-72 72-76 76-80 80-84 84-88 88-92 92-96 96-100	0-4 4-8 8-12 12-16 16-20 20-24 24-28 28-32 32-36 36-40 40-44 44-48 48-52 52-56 56-60 60-64 64-68 68-72 72-76 76-80 80-84 84-88 88-92 92-96 96-100									0-4 4-8 8-12 12-16 16-20 20-24 24-28 28-32 32-36 36-40 40-44 44-48 48-52 52-56 56-60 60-64 64-68 68-72 72-76 76-80 80-84 84-88 88-92 92-96 96-100	
						DATE DRILLED <i>6-18-03</i>				PAGE <i>2 of 2</i>	
						DRILLING METHOD <i>HSA</i>					
						DRILLED BY <i>ELITE DRILLING</i>					
						LOGGED BY <i>ED KRISH</i>					
						EXISTING GRADE ELEVATION (FT AMSL) _____					
						LOCATION OR GRID COORDINATES _____					

EXPLANATION

- ▼ Water Table (24 Hour)
- ▽ Water Table (Time of Boring)
- PID Photoionization Detection (ppm)
- NO. Identifies Sample by Number
- TYPE Sample Collection Method

[X] SPLIT-BARREL [] THIN-WALLED TUBE	[] AUGER [] CONTINUOUS SAMPLER	[] ROCK CORE [] NO RECOVERY
--	-------------------------------------	----------------------------------

DEPTH Depth Top and Bottom of Sample
 REC. Actual Length of Recovered Sample in Feet

GRAPHIC LOG LEGEND

[] CLAY [] SILT [] SAND [] GRAVEL [] SILTY CLAY [] CLAYEY SILT	[] DEBRIS FILL [] HIGHLY ORGANIC (PEAT) [] SANDY CLAY [] CLAYEY SAND
---	---

DATE DRILLED
6-18-03

PAGE
2 of 2

DRILLING METHOD
HSA

DRILLED BY
ELITE DRILLING

LOGGED BY
ED KRISH

EXISTING GRADE ELEVATION (FT AMSL)

LOCATION OR GRID COORDINATES

KERR-McGEE CORPORATION HYDROLOGY DEPARTMENT MONITORING WELL INSTALLATION DIAGRAM

FLUSH
M...
M...

Protective Pipe

Yes No

Steel PVC

Surveying Pin ?

Yes No

Casing Cap Vent ? Yes No

Lock ? Yes No

Weep Hole ? Yes No

Concrete Pad _____ Ft. x _____ Ft. x _____ Inches

Concrete

DEPTH
FROM
TOP OF
CASING

DRILLING INFORMATION:

- 1. Borehole Diameter = 9 Inches.
- 2. Were Drilling Additives Used ? Yes No
Revert Bentonite Water
Solid Auger Hollow Stem Auger
- 3. Was Outer Steel Casing Used ? Yes No
Depth = _____ to _____ Feet.
- 4. Borehole Diameter for Outer Casing _____ Inches.

WELL CONSTRUCTION INFORMATION:

- 1. Type of Casing: PVC Galvanized Teflon
Stainless Other _____
- 2. Type of Casing Joints: Screw-Couple Glue-Couple Other _____
- 3. Type of Well Screen: PVC Galvanized
Stainless Teflon Other _____
- 4. Diameter of Casing and Well Screen:
Casing 2 Inches, Screen 2 Inches.
- 5. Slot Size of Screen: .020
- 6. Type of Screen Perforation: Factory Slotted
Hacksaw Drilled Other _____
- 7. Installed Protector Pipe w/Locks: Yes No

WELL DEVELOPMENT INFORMATION:

- 1. How was Well Developed ? Bailing Pumping
Air Surging (Air or Nitrogen) Other _____
- 2. Time Spent on Well Development ?
_____ / _____ Minutes/Hours
- 3. Approximate Water Volume Removed ? _____ Gallons
- 4. Water Clarity Before Development ? Clear
Turbid Opaque
- 5. Water Clarity After Development ? Clear
Turbid Opaque
- 6. Did Water have Odor ? Yes No
If Yes, Describe _____
- 7. Did Water have any Color ? Yes No
If Yes, Describe _____

WATER LEVEL INFORMATION:

Water Level Summary (From Top of Casing)

During Drilling _____ Ft. Date _____
 Before Development 32.93 Ft. Date 6-19-03
 After Development _____ Ft. Date _____

Cement/Bentonite Grout Mix

Yes No

5.5 Gallons Water to
94Lb. Bag Cement &
3-5 Lb. Bentonite
Powder

Other: _____

Bentonite Seal

Pellets Slurry

Filter Pack
Above Screen

FILTER PACK MATERIAL

Silica Sand

Washed Sand

Pea Gravel

Other: _____

Sand Size 12-20

Dense Phase Sampling Cup

Bottom Plug
Yes No

Overdrilled Material
Backfill

Grout Sand

Caved Material

Other: _____

Driller/Firm TECH/BLITE

Drill Rig Type CMG 75

Date Installed 6-15-03

Drill Crew Tom, Chris

Well No. 017A

Kerr-McGee
Hydrologist ED KESH

LOG OF WATER SAMPLE WELL 25

DATE 5/14/64

LOCATION KMCC, Henderson, NV

ELEVATION

DEPTH IN FEET	SAMPLES SYMBOL	SOIL DESCRIPTION	COLOR	MOISTURE	CONSISTENCY	REMARKS
0						
2	SW	GRAVELLY SAND	light brown			
4						
6						
8						
10						
12						
14						
16						
18						
20	SW/ GW	SAND & GRAVEL	light brown & dark brown			
22						
24						
26						
28						
30	CL	SILT & CLAY				
32						
34						
36						
38						
40						

End of well at 40.0 ft.

THIS SUMMARY APPLIES ONLY AT THIS LOCATION AND AT THE TIME OF LOGGING. SUBSURFACE CONDITIONS MAY DIFFER AT OTHER LOCATIONS AND MAY CHANGE AT THIS LOCATION WITH THE PASSAGE OF TIME. THE DATA PRESENTED IS A SIMPLIFICATION OF ACTUAL CONDITIONS ENCOUNTERED.

DRAWING NO.

WELL CONSTRUCTION DIAGRAM
 WELL M-36
 HENDERSON, NEVADA

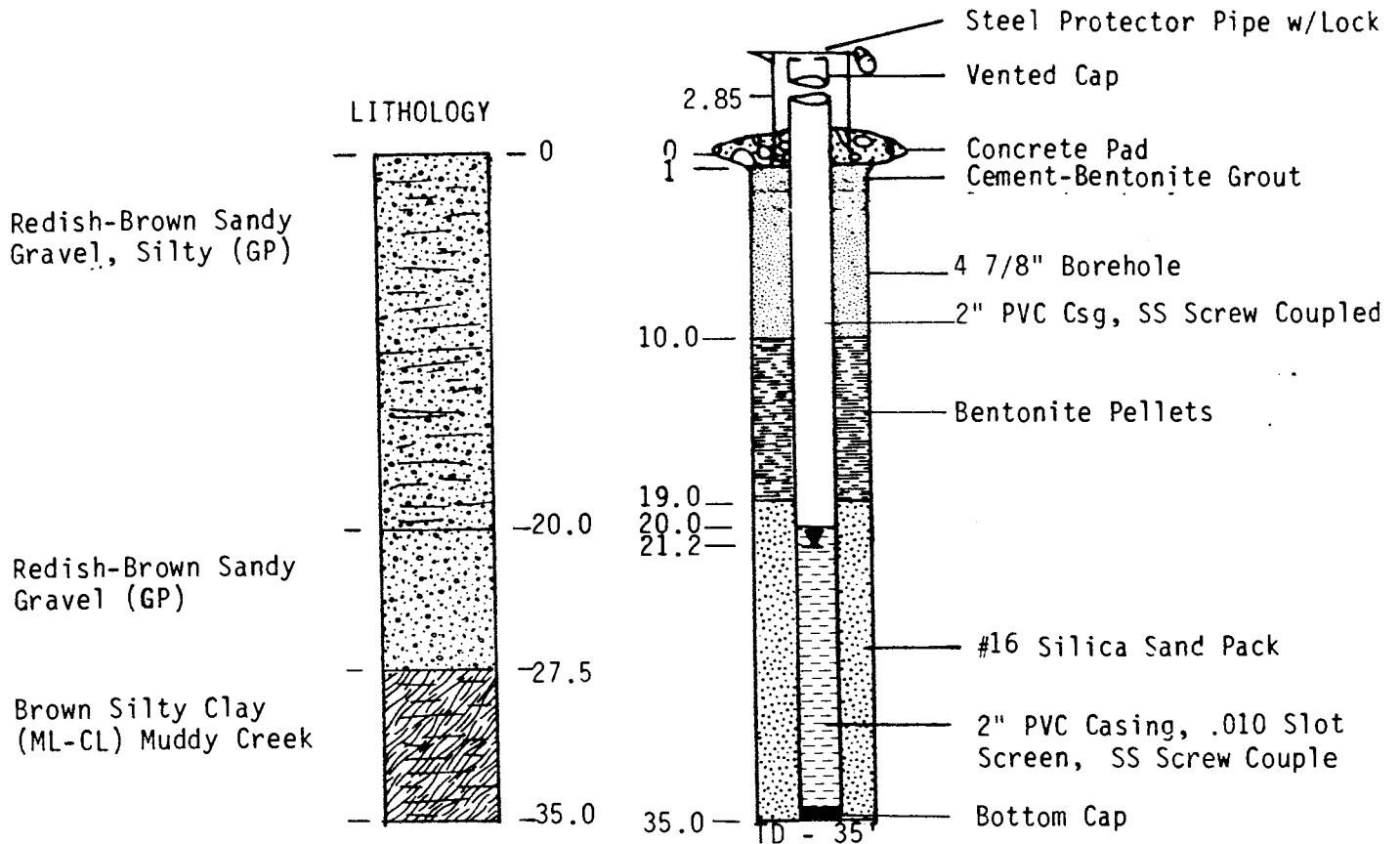

DATE DRILLED: 6/26/85
 DRILLED BY: Converse Cons.
 DRILLING METHOD: Rotary Wash-Water
 LOGGED BY: Bert Smith, Kerr-McGee
 CASING ELEVATION: 1758.88' MSL

WELL CONSTRUCTION DIAGRAM
 WELL M-38
 HENDERSON, NEVADA

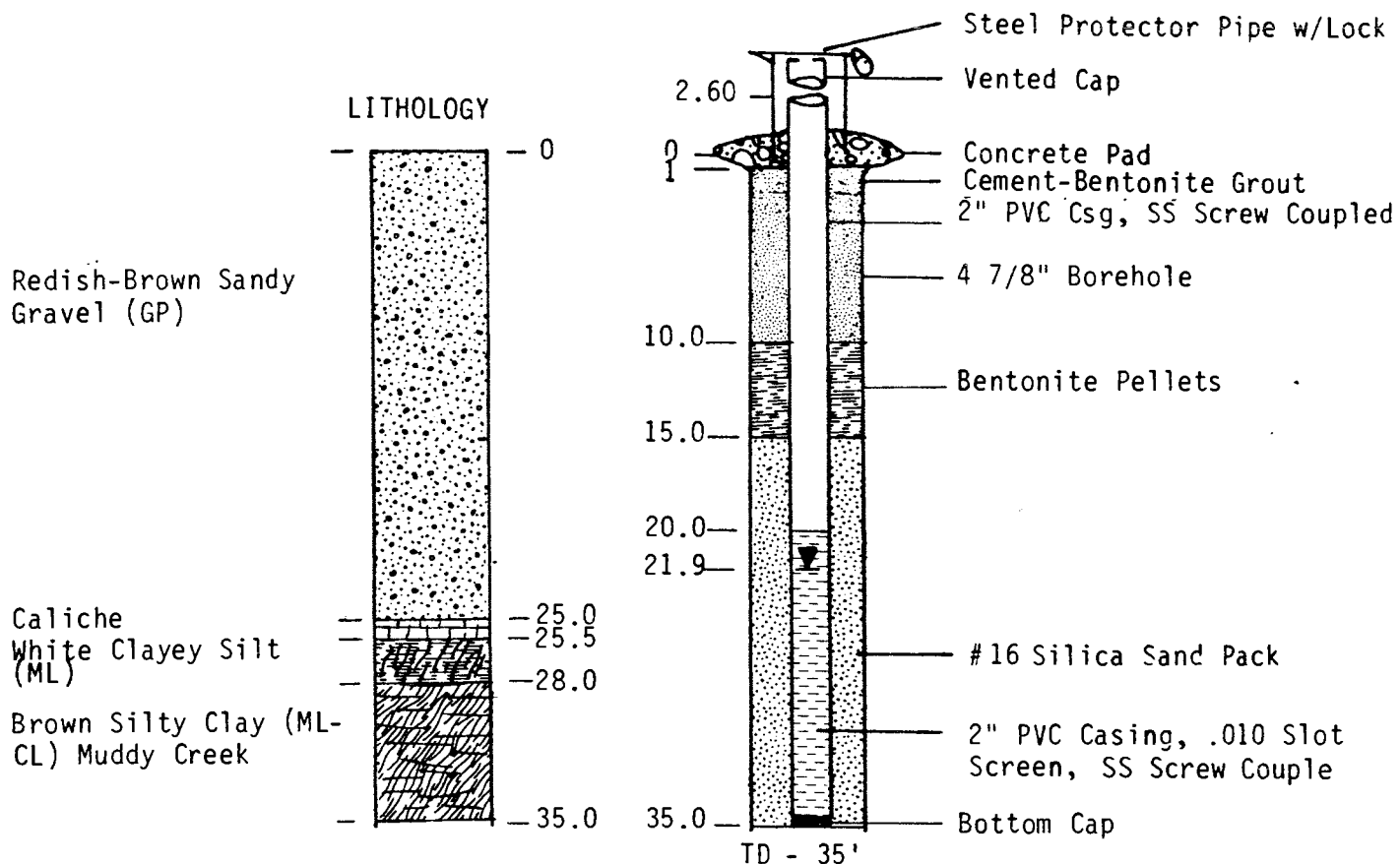

DATE DRILLED: 6/26/85
 DRILLED BY: Converse Cons.
 DRILLING METHOD: Rotary Wash - Water
 LOGGED BY: Bert Smith, Kerr-McGee
 CASING ELEVATION: 1759.08' MSL

ENSR
1220 Avenida Acaso
Camarillo, CA 93012
(805)388-3775

Client: Tronox LLC
Project Number: 04020-023-160
Site Description/Location: 500' South of Interceptor Well Field, Henderson, NV
Coordinates: Not Surveyed Elevation:
Drilling Method: Sonic with continuous coring
Sample Type(s): Split Spoon and Core Boring Diameter: 8 in.

Well No. M-111A

Sheet: 1 of 2

Monitoring Well Installed: Yes

Screened Interval: 29.7-39.7 ft.

Weather: Sunny, cool

Logged By: E. Krish

Date/Time Started: 12/5/2007 12:00

Depth of Boring: 40 ft

Drilling Contractor: Boart Longyear / D. Cervantez

Backfill: NA

Date/Time Finished: 12/10/2007 11:15

Water Level: 34 ft.

DEPTH (ft)	Sample ID	Sample Depth (ft)	Blows per 6"	Recovery (ft)	Headspace (ppm)	USCS	Graphic Log	MATERIAL IDENTIFICATION, color, description of fine grained material (silt and clay) description of coarse grained material (sand and gravel), structural or mineralogical features, density or stiffness, moisture content, odors or staining.	Well Diagram
5						SM	ALLUVIUM: SILTY GRAVELLY SAND, moderate yellowish brown (10YR 5/4), 20% silt, 30% subangular to subrounded fine grained volcanic pea gravel to 1/2" with local calichification, 50% very fine to very coarse grained subangular to subrounded sand (dominant fine to coarse grained).	Steel Guard Pipe 3 Feet Above Ground Surface	
10						SM	GRAVELLY SILTY SAND, moderate yellowish brown (10YR 5/4), 20% silt, 20% angular to subrounded fine grained volcanic pea gravel to 3/8", 60% very fine to very coarse grained (dominant fine to coarse grained) subangular to subrounded moderately calcareous sand.	Top of Riser 2.6 Feet Above Ground Surface	
15						SM	SILTY GRAVELLY SAND, moderate yellowish brown (10YR 5/4), 20% silt, 30% pea gravel (dominant up to 1/2-3/4" with trace 2-3" angular to subangular volcanic clasts), 50% very fine to very coarse grained (dominant fine to medium grained) subangular to subrounded sand. Moderately common calichification.	6" Sch 40 PVC Riser	
20						SM	-at 13 feet bgs 6" calichified sandy pea gravel.	Cement (94%) and Bentonite (6%) Slurry	
25						SM	SILTY SAND, moderate yellowish brown (10YR 5/2), 30% silt, 5% 1/10-1/8" fine grained volcanic pea gravel, 70% very fine to very coarse grained (dominant very fine to medium grained) subangular to subrounded sand.	Bentonite Seal	
30						SM	SILTY GRAVELLY SAND, moderate yellowish brown (10YR 5/2), 20% silt, 30% fine grained pea gravel to 1/2-3/4" angular to subangular volcanic moderately calichified sand gravel clasts, 50% very fine to very coarse grained (dominant fine to medium grained) subangular to subrounded sand.	Sand Pack (#2-12)	
35						ML	-local hard calichified zone, pale orange (10YR 8/2), at 19-19.5 feet bgs. -local hard calichified zone, pale orange (10YR 8/2), at 21-21.5 feet bgs. -local hard calichified zone, pale orange (10YR 8/2), at 24-25 feet bgs. -local hard calichified zone, pale orange (10YR 8/2), at 29-29.5 feet bgs. MUDDY CREEK FORMATION: CLAYEY SILT, SILT, AND SANDY SILT, light brown (5YR 6/4), interbedded, common local nodular caliche zones. At 30-34 feet bgs nodules to 3" in clayey silt, moist. -from 34-36 feet bgs 65% silt, 10% clay, 25% very fine grained sand. Groundwater encountered at 34 feet bgs.	Well Screen	

Notes: Muddy Creek Formation begins at 30 feet bgs.

1766.25
1756.25

WELL CONSTRUCTION TRONOX CAPTURE WP: GPJ ENSR CA GDT 4/25/08

ENSR AECOM ENSR 1220 Avenida Acaso Camarillo, CA 93012 (805)388-3775	Client: Tronox LLC		Well No. M-111A
	Project Number: 04020-023-160		
	Site Description/Location: 500' South of Interceptor Well Field, Henderson, NV		
	Coordinates: Not Surveyed	Elevation:	
	Drilling Method: Sonic with continuous coring		
Sample Type(s): Split Spoon and Core		Boring Diameter: 8 In.	Sheet: 2 of 2
Weather: Sunny, cool		Logged By: E. Krish	Date/Time Started: 12/5/2007 12:00
Drilling Contractor: Boart Longyear / D. Cervantez		Backfill: NA	Date/Time Finished: 12/10/2007 11:15
			Depth of Boring: 40 ft.
			Water Level: 34 ft.

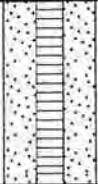
DEPTH (ft)	Sample ID	Sample Depth (ft)	Blows per 6"	Recovery (ft)	Headspace (ppm)	USCS	Graphic Log	MATERIAL IDENTIFICATION, color, description of fine grained material (silt and clay) description of coarse grained material (sand and gravel), structural or mineralogical features, density or stiffness, moisture content, odors or staining.	Well Diagram
40						ML		MUDDY CREEK FORMATION: CLAYEY SILT, SILT, AND SANDY SILT , light brown (5YR 6/4), interbedded, common local nodular caliche zones. At 30-34 feet bgs nodules to 3" in clayey silt, moist. <i>(continued)</i> -from 36-38 feet bgs 80% silt, 10% clay, 10% very fine grained sand. -from 38-40 feet bgs 65% silt, 10% clay, 25% very fine grained sand	 (2" Sch. 40 PVC, 0.01" Slot)

Total Depth = 40 feet.
 Boring Terminated
 Target depth achieved

Notes: Muddy Creek Formation begins at 30 feet bgs.

Well Log

Project Number: 2027.02		Boring No.: M-150	
Project Name: Vertical Delineation / Capture Zone Eval.		Logged by: Ed Krish	
Drilling Contractor: Boart Longyear		Date Started: 09/17/09	Date Completed: 09/17/09
Drilling Method: Rotary Sonic		Total Depth (ft bgs): 145.0	Depth to Water (ft bgs): 63.0
Borehole Dia. (in): 6.0	Completion: Monument	Surface Elevation (ft MSL):	Top of Casing (ft MSL): 1759.107
Blank Casing: SCH 40 PVC	Slotted Casing: Factory slotted SCH 40 PVC, 0.020" Slots	Filter Pack Type: Silica Sand Size: #10-20	
Casing Dia. (in): 2 From (ft bgs): 0 To: 125	Casing Dia. (in): 2 From (ft bgs): 125 To: 145	Interval (ft bgs) From: 121 To: 145	
Remarks: Boring advanced with 6.0" casing to 145.0'; Neat Cement from 0' to 117'; 3/8" Holeplug from 117' to 121'.			

Depth (ft)	Sample I.D. Sample Time	Sample Type	Graphic Log	USCS Code	Formation Name	Material Description	Water Level	10.6 ev PID (ppm)	11.7 ev PID (ppm)	Well Construction
1				SW-SM	QAI	SAND, gravelly, silty; Light brown (5YR 6/4), 60% fine to coarse with minor very coarse, sub-rounded to sub-angular, sand; 20% silt; 20% volcanic pea gravel to 3/4" with locally common cobbles to 4".				
2										
3										
4										
5										
6										
7										
8										
9										
10				SW	QAI	SAND, gravelly, pale yellowish brown (10YR 6/2). 70% fine to medium with common coarse to very coarse sub-rounded to sub-angular sand. 30% volcanic pea gravel (1/8" - 3/4") with minor 1" - 2", angular to sub-angular. Trace silt.				
11										
12										
13										
14										
15										
16				SW	QAI	SAND (SW): silty, gravelly, light brown (5YR 5/6), 60% fine to medium with common coarse to very coarse sub-rounded to sub-angular sand. 10% volcanic pea gravel to 1/2". Wet @ 28'				
17										
18										
19				ML	Tmcf	SILT (ML), and sandy silt interbedded, moderate yellowish orange (10YR 6/4). Predominately silt with minor thin layers of sandy silt with 10% - 20% very fine grained, sub-angular to sub-rounded sand. Minor scattered zones of semi-hard caliche nodules to 1-1/2".				
20										
21										
22										
23										
24										
25										
26										
27										
28										
29										
30										
31										
32										
33										
34										

DRB-ENVIRO WELL LOG TRONOX-1.GPJ 12/1/09

Well Log

Project Number: 2027.02	Boring No.: M-150
Project Name: Vertical Delineation / Capture Zone Eval.	Logged by: Ed Krish
Drilling Contractor: Boart Longyear	Date Started: 09/17/09 Date Completed: 09/17/09

Depth (ft)	Sample I.D. Sample Time	Sample Type	Graphic Log	USCS Code	Formation Name	Material Description	Water Level	10.6 ev PID (ppm)	11.7 ev PID (ppm)	Well Construction
36						SILT (ML), and sandy silt interbedded, moderate yellowish orange (10YR 6/4). Predominately silt with minor thin layers of sandy silt with 10% - 20% very fine grained, sub-angular to sub-rounded sand. Minor scattered zones of semi-hard caliche nodules to 1-1/2".				
37										
38										
39										
40										
41										
42										
43										
44										
45				ML	Tmcf					
46										
47										
48										
49										
50										
51										
52										
53										
54										
55										
56				SW-SM	Tmcc	SAND and silty sand, interbedded. Pale yellowish brown (10YR 6/2). Thin layers (2" - 3") of clean fine to medium with minor coarse grained sub-rounded to sub-angular, sand with thicker zones (6" - 8") with 50% silt as matrix.				
57										
58										
59										
60										
61										
62										
63										
64										
65										
66										
67										
68				ML	Tmcf					
69										
70										
71										
72										
73										
74										

▽

DRB-ENVIRO WELL LOG TRONOX-1.GPJ 12/1/09

Well Log

Project Number: 2027.02	Boring No.: M-150
Project Name: Vertical Delineation / Capture Zone Eval.	Logged by: Ed Krish
Drilling Contractor: Boart Longyear	Date Started: 09/17/09
	Date Completed: 09/17/09

Depth (ft)	Sample I.D. Sample Time	Sample Type	Graphic Log	USCS Code	Formation Name	Material Description	Water Level	10.6 ev PID (ppm)	11.7 ev PID (ppm)	Well Construction
76						SILT (ML), sandy with minor SILT interbedded. Light brown (5YR 6/4), predominantly sandy silt with 10% - 20% very fine grained, sub-angular to sub-rounded sand. Scattered thin caliche zones of soft thin layers and hard nodules.				
77										
78										
79						77' - 77.5' sandy pea gravel up to 3/8" diameter, 30% - 40% fine to coarse, sub-rounded to sub-angular volcanic granules.				
80						80' - 95' common caliche nodules.				
81										
82										
83										
84										
85										
86										
87										
88										
89										
90						80' - 95' common caliche nodules.				
91										
92										
93										
94										
95				ML	Tmcf					
96										
97										
98										
99										
100										
101										
102										
103										
104										
105										
106										
107										
108						108' - 110' common caliche nodules.				
109										
110										
111										
112										
113										
114						114' - 116' common caliche nodules.				

DRB-ENVIRO WELL LOG TRONOX-1.GPJ 12/1/09

Well Log

Project Number: 2027.02

Boring No.: M-150

Project Name: Vertical Delineation / Capture Zone Eval.

Logged by: Ed Krish

Drilling Contractor: Boart Longyear

Date Started: 09/17/09

Date Completed: 09/17/09

Depth (ft)	Sample I.D. Sample Time	Sample Type	Graphic Log	USCS Code	Formation Name	Material Description	Water Level	10.6 ev PID (ppm)	11.7 ev PID (ppm)	Well Construction	
116				ML	Tmcf	SILT (ML), sandy with minor SILT interbedded. Light brown (5YR 6/4), predominantly sandy silt with 10% - 20% very fine grained, sub-angular to sub-rounded sand. Scattered thin caliche zones of soft thin layers and hard nodules.					
117											
118											
119											
120											
121						Clay, with minor amounts of silt. White (N9) to 124' then mottled white (N9) and yellow gray (5Y 8/1). Abundant soft caliche to 124', then minor scattered soft caliche to 133'.					
122											
123											
124											
125											
126				CL	Tmcf						
127											
128											
129											
130											
131											
132											
133											
134						SILT (ML), sandy, greyish orange (10YR 7/4). 10% - 15% very fine grained, sub-angular to sub-rounded sand in silt matrix. Scattered soft caliche layers and semi-hard nodules to 1".					
135											
136											
137											
138											
139				ML	Tmcc						
140											
141											
142											
143											
144											
145				ML	Tmcf	SILT (ML), moderate greyish orange (10YR 6/4) with 0% - 10% very fine grained sand in matrix.					
146											
147						TD = 145' on 9-17-09					
148											
149											
150											
151											
152											
153											
154											

DRB-ENVIRO WELL LOG TRONOX-1.GPJ 12/1/09

Well Log

Project Number: 2027.02		Boring No.: M-154	
Project Name: Vertical Delineation / Capture Zone Eval.		Logged by: Ed Krish	
Drilling Contractor: Boart Longyear		Date Started: 09/30/09	Date Completed: 10/01/09
Drilling Method: Rotary Sonic		Total Depth (ft bgs): 195.0	Depth to Water (ft bgs):
Borehole Dia. (in): 6.0	Completion: Monument	Surface Elevation (ft MSL):	Top of Casing (ft MSL): 1758.893
Blank Casing: SCH 40 PVC Casing Dia. (in): 2 From (ft bgs): 0 To: 175	Slotted Casing: Factory slotted SCH 40 PVC, 0.020" Slots Casing Dia. (in): 2 From (ft bgs): 175 To: 195	Filter Pack Type: Silica Sand Size: #10-20 Interval (ft bgs) From: 171 To: 195	
Remarks: Boring located 15' west of M-150; Neat Cement from 0' to 167'; 3/8" Holeplug from 167' to 171'.			

Depth (ft)	Sample I.D. Sample Time	Sample Type	Graphic Log	USCS Code	Formation Name	Material Description	Water Level	10.6 ev PID (ppm)	11.7 ev PID (ppm)	Well Construction
1										
2										
3										
4										
5										
6										
7										
8										
9										
10										
11										
12										
13										
14										
15										
16										
17										
18										
19										
20										
21										
22										
23										
24										
25										
26										
27										
28										
29										
30										
31										
32										
33										
34										

DRB-ENVIRO WELL LOG TRONOX-1.GPJ 12/1/09

Well Log

Project Number: 2027.02

Boring No.: M-154

Project Name: Vertical Delineation / Capture Zone Eval.

Logged by: Ed Krish

Drilling Contractor: Boart Longyear

Date Started: 09/30/09

Date Completed: 10/01/09

Depth (ft)	Sample I.D. Sample Time	Sample Type	Graphic Log	USCS Code	Formation Name	Material Description	Water Level	10.6 ev PID (ppm)	11.7 ev PID (ppm)	Well Construction
36										
37										
38										
39										
40										
41										
42										
43										
44										
45										
46										
47										
48										
49										
50										
51										
52										
53										
54										
55										
56										
57										
58										
59										
60										
61										
62										
63										
64										
65										
66										
67										
68										
69										
70										
71										
72										
73										
74										

DRB-ENVIRO WELL LOG TRONOX-1.GPJ 12/1/09

Well Log

Project Number: 2027.02

Boring No.: M-154

Project Name: Vertical Delineation / Capture Zone Eval.

Logged by: Ed Krish

Drilling Contractor: Boart Longyear

Date Started: 09/30/09

Date Completed: 10/01/09

Depth (ft)	Sample I.D. Sample Time	Sample Type	Graphic Log	USCS Code	Formation Name	Material Description	Water Level	10.6 ev PID (ppm)	11.7 ev PID (ppm)	Well Construction
76										
77										
78										
79										
80										
81										
82										
83										
84										
85										
86										
87										
88										
89										
90										
91										
92										
93										
94										
95										
96										
97										
98										
99										
100										
101										
102										
103										
104										
105										
106										
107										
108										
109										
110										
111										
112										
113										
114										

DRB-ENVIRO WELL LOG TRONOX-1.GPJ 12/1/09

Well Log

Project Number: 2027.02

Boring No.: M-154

Project Name: Vertical Delineation / Capture Zone Eval.

Logged by: Ed Krish

Drilling Contractor: Boart Longyear

Date Started: 09/30/09

Date Completed: 10/01/09

Depth (ft)	Sample I.D. Sample Time	Sample Type	Graphic Log	USCS Code	Formation Name	Material Description	Water Level	10.6 ev PID (ppm)	11.7 ev PID (ppm)	Well Construction
116										
117										
118										
119										
120										
121										
122										
123										
124										
125										
126										
127										
128										
129										
130										
131										
132										
133						(133' - 143' continued from M-150)				
134						SILT, sandy.				
135										
136										
137										
138				ML	Tmcf					
139										
140										
141										
142										
143										
144						SILT, medium greyish orange (10YR 6/4) with 0% - 10%				
145						very fine grained sand locally.				
146										
147										
148										
149				ML	Tmcf					
150										
151										
152										
153						153' - 153.5', moderate caliche nodules and stringers.				
154										

DRB-ENVIRO.WELL LOG TRONOX-1.GPJ 12/1/09

Well Log

Project Number: 2027.02	Boring No.: M-154
Project Name: Vertical Delineation / Capture Zone Eval.	Logged by: Ed Krish
Drilling Contractor: Boart Longyear	Date Started: 09/30/09 Date Completed: 10/01/09

Depth (ft)	Sample I.D. Sample Time	Sample Type	Graphic Log	USCS Code	Formation Name	Material Description	Water Level	10.6 ev PID (ppm)	11.7 ev PID (ppm)	Well Construction
156						SILT, medium greyish orange (10YR 6/4) with 0% - 10% very fine grained sand locally.				
157						156' - 156.5', moderate caliche nodules to 1".				
158										
159										
160				ML	Tmcf	159.5' - 160', moderate caliche nodules to 1/2".				
161										
162										
163										
164										
165						Moderate caliche nodules.				
166						SILT, sandy, medium greyish orange (10YR 6/4) with 20% - 30% disseminated very fine grained sand in matrix. Locally calichified.				
167						166' - 168', with 10% very coarse grained sand and 1/8" granules floating in matrix.				
168										
169										
170						Moderate caliche nodules.				
171										
172										
173										
174										
175				ML	Tmcc					
176										
177										
178										
179						179' - 179.5', moderate caliche nodules.				
180										
181										
182						182' - 182.5', moderate caliche nodules.				
183										
184										
185						SAND, silty, moderate greyish orange (10YR 6/4), 60% very fine grained sand with 40% silt in matrix. Locally calcareous. Hard caliche nodules 184' - 184.5'.				
186										
187										
188										
189										
190				SM	Tmcc	190' - 195', moderate caliche nodules and stringers.				
191										
192										
193										
194										

DRB-ENVIRO WELL LOG TRONOX-1.GPJ 12/1/09

Well Log

Project Number: 2027.02	Boring No.: M-154
Project Name: Vertical Delineation / Capture Zone Eval.	Logged by: Ed Krish
Drilling Contractor: Boart Longyear	Date Started: 09/30/09
	Date Completed: 10/01/09

Depth (ft)	Sample I.D. Sample Time	Sample Type	Graphic Log	USCS Code	Formation Name	Material Description	Water Level	10.6 ev PID (ppm)	11.7 ev PID (ppm)	Well Construction
196						TD = 195' on 10-1-09				
197										
198										
199										
200										
201										
202										
203										
204										
205										
206										
207										
208										
209										
210										
211										
212										
213										
214										
215										
216										
217										
218										
219										
220										
221										
222										
223										
224										
225										
226										
227										
228										
229										
230										
231										
232										
233										
234										

DRB-ENVIRO WELL LOG TRONOX-1.GPJ 12/1/09

EXPLORATION LOG RSAM5

PROJECT: TRONOX PHASE B	PROJECT NO.: 20092518V1
EXPLORATION LOCATION: TRONOX AREA 2	EXPLORATION DATE: 7/30/2009
EXPLORATION SIZE (dia.): 3" CORE BARREL	EQUIPMENT: SDC550-24 SONIC CORE RIG
ELEVATION: EXISTING GROUND SURFACE	LOGGED BY: SEARS/GAREY

INITIAL DEPTH TO WATER: NOT ENCOUNTERED	DATE MEASURED: NA
FINAL DEPTH TO WATER: NOT ENCOUNTERED	DATE MEASURED: NA

ELEVATION/ DEPTH	SOIL & SAMPLE SYMBOLS	USCS	DESCRIPTION	PI	LL	MOISTURE CONTENT (%)	DRY DENSITY (pcf)	% SWELL	WELL CONSTRUCTION
		SW	<p>Brown (7.5YR 4/4) well graded SAND, 95% fine-coarse grained, subangular to subrounded, sand, 5% gravel, loose, dry, non plastic, high K, no odor, strong reaction to HCl. Collect samples RSAm5-0.5B, RSAM5009-0.5B; PID readings: 10.6eV=1.4 ppmV, 11.7eV=0.0 ppmV.</p>						
			<p>Collect RSAM5-10B; PID readings: 10.6eV=13.3 ppmV, 11.7eV=5.7 ppmV.</p>						
		SW	<p>Brown (7.5YR 3/4) well graded SAND. 90% fine-coarse grained, subangular to subrounded sand, 5% subrounded gravel, 55 silt. non-low plasticity, low K, strong reaction to HCl, no odor. trace caliche occurring as thin layers and nodules.</p>						

The descriptions contained within this exploration log apply only at the specific exploration location and at the time the exploration was made. It is not intended to be representative of subsurface conditions at other locations or times.

EXPLORATION LOG RSAM5

PROJECT: TRONOX PHASE B **PROJECT NO.:** 20092518V1
EXPLORATION LOCATION: TRONOX AREA 2 **EXPLORATION DATE:** 7/30/2009
EXPLORATION SIZE (dia.): 3" CORE BARREL **EQUIPMENT:** SDC550-24 SONIC CORE RIG
ELEVATION: EXISTING GROUND SURFACE **LOGGED BY:** SEARS/GAREY

INITIAL DEPTH TO WATER: NOT ENCOUNTERED **DATE MEASURED:** NA
FINAL DEPTH TO WATER: NOT ENCOUNTERED **DATE MEASURED:** NA

ELEVATION/ DEPTH	SOIL & SAMPLE SYMBOLS	USCS	DESCRIPTION	PI	LL	MOISTURE CONTENT (%)	DRY DENSITY (pcf)	% SWELL	WELL CONSTRUCTION
17.5		SP-SM	Light brown (7.5YR 6/3) well graded SAND with silt, 80% fine grained sand, 20% silt, low plasticity, low K, reacts to HCl, trace gypsum?, no odor.						
20									
22.5		SW	Brown (7.5YR 4/3) well graded SAND, 95% fine-coarse grained, subangular to subrounded sand, 5% fine grained, subrounded gravel, strong cementation, reacts with HCl, no odor.						
25									
27.5			Collect sample RSAM5-28B; PID readings: 10.6eV=0.6 ppmV, 11.7eV=0.0 ppmV.						
30		SP-SM SW	...fine grained SAND with silt, 3" layer. END OF BORING AT 29.5 FEET						
32.5									

The descriptions contained within this exploration log apply only at the specific exploration location and at the time the exploration was made. It is not intended to be representative of subsurface conditions at other locations or times.

ENSR AECOM ENSR 1220 Avenida Acaso Camarillo, CA 93012 805-388-3775 www.ensr aecom.com	<i>Client:</i> Tronex	Boring No. SA-15	
	<i>Project Number:</i> 04020-023-401		
	<i>Site Location:</i> Henderson, NV		
	<i>Coordinates:</i> 26719002 N 827478 E <i>Elevation:</i> 1768 FT		
	<i>Drilling Method:</i> Sonic with continuous coring		
<i>Sample Type(s):</i> Split Spoon and Core <i>Boring Diameter:</i> 7 in.	<i>Sheet:</i> 1 of 2		
<i>Weather:</i> Clear, slight breeze, mid 80's	<i>Logged By:</i> E. Krish	<i>Date/Time Started:</i> 11/8/2006	<i>Monitoring Well Installed:</i> No
<i>Drilling Contractor:</i> Prosonic	<i>Backfill:</i> Tremmied grout	<i>Date/Time Finished:</i> 11/8/2006	<i>Screened Interval:</i>

<i>Weather:</i> Clear, slight breeze, mid 80's	<i>Logged By:</i> E. Krish	<i>Date/Time Started:</i> 11/8/2006	<i>Depth of Boring:</i> 40 FT
<i>Drilling Contractor:</i> Prosonic	<i>Backfill:</i> Tremmied grout	<i>Date/Time Finished:</i> 11/8/2006	<i>Water Level:</i> 37 FT

DEPTH (ft)	Sample ID	Sample Depth (ft)	Blows per 6"	Recovery (ft)	Headspace (ppm)	USCS	Graphic Log	MATERIAL IDENTIFICATION, color, description of fine grained material (silt and clay) description of coarse grained material (sand and gravel), structural or mineralogical features, density or stiffness, moisture content, odors or staining.
5	SA15-0.5					SW		ALLUVIUM: GRAVELLY SAND , moderate brown (5YR 4/4), 10-15% silt, 60-75% fine to coarse grained sand with minor very fine and very coarse grained sand, 15-25% gravel, angular to subangular, medium dense, dry, no odor/stain -from 3-5' pebble/cobble sized gravel, to 2" diameter, common
10	SA15-10			10				-from 10-13' caliche, calcareous coatings common
15								
20	SA15-20			10				-from 22-24' grayish orange caliche, soft, calcareous coatings common
25								
30	SA15-30			10			-from 28-32' grayish orange caliche, semi-hard, calcareous coatings common	
35						ML	MUDDY CREEK FORMATION: SILT , light brown, 0-5% clay, 85-100% silt, 0-10% sand, subrounded, moist, no odor/stain, silt and sandy silt interbedded	

BORING LOG 04020023401-LOGS.GPJ ENSR CA.GDT 1/29/07

Notes:

ENSR | AECOM

ENSR
1220 Avenida Acaso
Camarillo, CA 93012
805-386-3775
www.ensr.aecom.com

Client: Tronox
Project Number: 04020-023-401
Site Location: Henderson, NV
Coordinates: 26719002 N 827478 E Elevation: 1768 FT
Drilling Method: Sonic with continuous coring
Sample Type(s): Split Spoon and Core Boring Diameter: 7 In.

Boring No. SA-15

Sheet: 2 of 2
Monitoring Well Installed: No
Screened Interval:

Weather: Clear, slight breeze, mid 80's Logged By: E. Krish Date/Time Started: 11/8/2006 Depth of Boring: 40 FT
Drilling Contractor: Prosonic Backfill: Tremmied grout Date/Time Finished: 11/8/2006 Water Level: 37 FT

DEPTH (ft)	Sample ID	Sample Depth (ft)	Blows per 6"	Recovery (ft)	Headspace (ppm)	USCS	Graphic Log	
.....						ML		<p>MATERIAL IDENTIFICATION, color, description of fine grained material (silt and clay) description of coarse grained material (sand and gravel), structural or mineralogical features, density or stiffness, moisture content, odors or staining.</p> <p>MUDDY CREEK FORMATION: SILT, light brown, 0-5% clay, 85-100% silt, 0-10% sand, subrounded, moist, no odor/stain, silt and sandy silt interbedded (continued)</p> <p>-wet at 37'</p>
.....								
.....								
40				10				

Total Depth = 40 feet.
Boring Terminated
Target depth achieved

Notes:

BORING LOG 04020023401-LOGS.GPJ ENSR CA.GDT 1/29/07

Boring Log

Project Number: 2027.01		Boring No.: SA65	
Project Name: Tronox Phase B Investigation		Logged by: Dana R. Brown	
Drilling Contractor: Boart Longyear Company		Date Started: 08/25/09	Date Completed: 08/25/09
Drilling Method: Sonic		Total Depth (ft bgs): 35.0	Depth to Water (ft bgs): 31.0
Borehole Dia. (in): 6.0		Surface Elevation (ft MSL):	

Remarks: Abandoned with neat cement grout containing 3% (v/v) bentonite powder from 0.0' to 35.0'.

Depth (ft)	Sample I.D. Sample Time	Sample Type	Graphic Log	USCS Code	Material Description	10.6 ev PID (ppm)	11.7 ev PID (ppm)	Backfill
1	SA65-10B 11:27	SM		SM	Silty Sand (SM): Pale yellowish brown 10 YR (6/2), loose to very loose, dry. 5% fine sub-angular gravel to 3/8"+, 70% fine to medium sub-angular sand, 25% non-plastic fines. No odor or staining.	0.2	1.4	
2								
3								
4								
5								
6								
7								
8								
9								
10								
11	SA65-20B 11:45	SP		SP	Poorly Graded Sand (SP) to Poorly Graded Sand with Silt (SP-SM): Very pale orange 10 YR (8/2), loose to very loose, dry. 2% - 5% fine sub-angular gravel to 1/2", 75% fine sand, 20% (to 10% locally) non-plastic fines. No odor or staining. Gravelly lenses 10.5' - 11.8'; and 14.5' to 15.5'	0.0	1.1	
12								
13								
14								
15								
16								
17								
18								
19								
20								
21	SA65-32.5B 12:15	SP-SM		SP-SM	Poorly Graded Sand with Silt (SP-SM): Pale yellowish brown 10 YR (6/2), loose, dry to damp. Trace fine sub-angular gravel to 1/2", 80% fine to medium sand, 20% non-plastic fines. Some caliche as veinlets and grain coatings from 25' - 29'.	0.0	0.6	
22								
23								
24								
25								
26								
27								
28								
29								
30								
31	SA65-32.5B 12:15	SM		SM	Silty Sand (SM): Dark yellowish brown 10 YR (4/2), very loose, wet. Trace fine sub-angular gravel to 3/8"+, 75% medium sub-angular sand, 25% non-plastic fines. Vague organic odor, no staining.	0.0	14.4	
32								
33								
34								
34	SA65-32.5B 12:15	ML		ML	Silt with Sand (ML): Light brown 5 YR (5/6), medium dense to dense, wet. Trace fine sub-rounded gravel to 3/8"+, 20% - 35% fine sand, 80% - 65% non to moderate-plastic fines. Vague organic odor, no staining. Some caliche as veinlets and grain coatings.	23.0	0.7	

DRB-ENVIRO BORING 2027.01.GPJ 2/9/11

Boring Log

Project Number: 2027.01

Boring No.: SA65

Project Name: Tronox Phase B Investigation

Logged by: Dana R. Brown

Drilling Contractor: Boart Longyear Company

Date Started: 08/25/09

Date Completed: 08/25/09











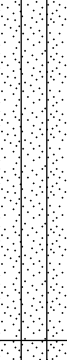

Depth (ft)	Sample I.D. Sample Time	Sample Type	Graphic Log	USCS Code	Material Description	10.6 ev PID (ppm)	11.7 ev PID (ppm)	Backfill
36					Total depth 35.0' @ 12:20, 8-25-09			
37								
38								
39								
40								
41								
42								
43								
44								
45								
46								
47								
48								
49								
50								
51								
52								
53								
54								
55								
56								
57								
58								
59								
60								
61								
62								
63								
64								
65								
66								
67								
68								
69								
70								
71								
72								
73								
74								

DRB-ENVIRO BORING 2027.01.GPJ 2/9/11

Boring Log

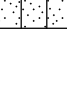
Project Number: 2027.01		Boring No.: SA94	
Project Name: Tronox Phase B Investigation		Logged by: Dana R. Brown	
Drilling Contractor: Boart Longyear	Date Started: 08/25/09	Date Completed: 08/25/09	
Drilling Method: Rotary Sonic	Total Depth (ft bgs): 31.5	Depth to Water (ft bgs): 30.0	
Borehole Dia. (in): 6.0	Surface Elevation (ft MSL):		

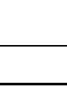
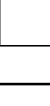
Remarks: Abandoned with neat cement grout containing 3% (v/v) bentonite powder from 0.0' to 31.5'.

Depth (ft)	Sample I.D. Sample Time	Sample Type	Graphic Log	USCS Code	Formation Name	Material Description	Water Level	10.6 ev PID (ppm)	11.7 ev PID (ppm)	Backfill
1	SA94-0.5B 08:09			SM	Qal	Silty Sand (SM): Pale yellowish brown 10 YR (6/2), very loose, dry. 5% fine sub-angular gravel to 1"+, 70% fine to medium sub-angular sand, 25% non-plastic fines. Vague organic odor, no staining.				
2										
3										
4	SA94-10B 08:34			SP	Qal	Poorly Graded Sand (SP): Very pale orange 10 YR (8/2), very loose, dry. 5% fine sub-angular gravel to 1/2", 89% fine to medium sand, 6% non-plastic fines. No odor or staining. Gravelly lenses 7.0' - 8.0'; and 12.5' to 13.5'		4.6	0.2	
5										
6										
7										
8										
9										
10										
11										
12										
13										
14	SA94-29B 08:50			SM	Qal	Silty Sand (SM): Pale yellowish brown 10 YR (6/2), loose, dry. 2% fine sub-angular gravel to 3/8"+, 70% fine - medium sub-angular sand, 28% non to moderate-plastic fines. No odor or staining. Some caliche as veinlets and grain coatings.		5.5	0.0	
15										
16										
17										
18										
19										
20										
21	SA94-29B 08:50			SM	Qal		8.4	0.0		
22										
23										
24	SA94-29B 08:50			SM	UMCf (MCf)	Silty Sand (SM): Moderate brown 5 YR (4/4), medium-dense to loose, moist to damp. 2% fine sub-angular gravel to 1/2"+, 65% medium sub-angular sand, 33% moderate-plastic fines. No odor or staining.	18.0	0.5		
25										
26										
27	SA94-29B 08:50			SM	UMCf (MCf)		18.6	0.4		
28										
29										
30	SA94-29B 08:50			SM	UMCf (MCf)		15.7	0.4		
31										
32										
33	SA94-32.5B 12:15					Total depth 31.5' @ 09:00, 8-25-09				
34										

DRB-ENVIRO BORING 2027.01.GPJ 1/13/10

EXPLORATION LOG SA104-A2

PROJECT: TRONOX PHASE B
EXPLORATION LOCATION: TRONOX AREA 2
EXPLORATION SIZE (dia.): 3" CORE BARREL
ELEVATION: EXISTING GROUND SURFACE

PROJECT NO.: 20092518V1
EXPLORATION DATE: 8-20-2009
EQUIPMENT: SDC550-24 SONIC CORE RIG
LOGGED BY: SEARS/GAREY

INITIAL DEPTH TO WATER: NOT ENCOUNTERED
FINAL DEPTH TO WATER: NOT ENCOUNTERED

DATE MEASURED: N/A
DATE MEASURED: N/A

ELEVATION/ DEPTH	SOIL & SAMPLE SYMBOLS	USCS	DESCRIPTION	PI	LL	MOISTURE CONTENT (%)	DRY DENSITY (pcf)	Pocket Penetrometer (tsf)	WELL CONSTRUCTION
		SW	SAND, dark brown (7.5YR 3/2), 95% fine to coarse sub-angular to sub-rounded sand, 5% volcanic gravel, dense, dry, no plasticity, calichified zones						
		SW	...color to reddish brown (5YR 4/4)						
		SW	Collect SA104-10B, SA104009-10B, PID readings: 10.6 eV = 0.4 ppmV, 11.7 eV = 0.6 ppmV SAND, reddish brown (5YR 5/3), 65% fine to medium sand, 30% coarse sand, 5% fine volcanic gravel, dense, dry, low plasticity, strong HCl reaction						
		SP	SAND, reddish brown (5YR 5/4), 90% fine to medium sand, 10% coarse sand, trace fine sub-angular gravel, dense, dry, low plasticity, strong HCl reaction						

The descriptions contained within this exploration log apply only at the specific exploration location and at the time the exploration was made. It is not intended to be representative of subsurface conditions at other locations or times.

EXPLORATION LOG SA104-A2

PROJECT: TRONOX PHASE B
 EXPLORATION LOCATION: TRONOX AREA 2
 EXPLORATION SIZE (dia.): 3" CORE BARREL
 ELEVATION: EXISTING GROUND SURFACE

PROJECT NO.: 20092518V1
 EXPLORATION DATE: 8-20-2009
 EQUIPMENT: SDC550-24 SONIC CORE RIG
 LOGGED BY: SEARS/GAREY

INITIAL DEPTH TO WATER: NOT ENCOUNTERED
 FINAL DEPTH TO WATER: NOT ENCOUNTERED

DATE MEASURED: N/A
 DATE MEASURED: N/A

ELEVATION/ DEPTH	SOIL & SAMPLE SYMBOLS	USCS	DESCRIPTION	PI	LL	MOISTURE CONTENT (%)	DRY DENSITY (pcf)	Pocket Penetrometer (tsf)	WELL CONSTRUCTION
20									
22.5		SP	...gravel to 1" diameter						
25									
27.5									
30		SP	...moderate calcite cementation with caliche nodules						
30		SP	Collect SA104-30B, PID readings: 10.6 eV = 0.3 ppmV, 11.7 eV = 0.0 ppmV SAND, reddish brown (5YR 4/3), 85% fine to medium sand, 15% coarse sand, trace fine sub-angular volcanic gravel, dense, dry, low plasticity, moderate cemented zones, small calcite crystals visible, caliche nodules less than 0.5" diameter present, strong HCl reaction						
32.5			END OF BORING AT 31.5 FEET						
35									

The descriptions contained within this exploration log apply only at the specific exploration location and at the time the exploration was made. It is not intended to be representative of subsurface conditions at other locations or times.

Boring Log

Project Number: 2027.01		Boring No.: SA129_2	
Project Name: Tronox Phase B Investigation		Logged by: Becki Dano	
Drilling Contractor: Boart Longyear Company		Date Started: 04/15/10	Date Completed: 04/15/10
Drilling Method: Sonic		Total Depth (ft bgs): 10.0	Depth to Water (ft bgs):
Borehole Dia. (in): 4		Surface Elevation (ft MSL):	

Remarks: Abandoned with neat cement grout containing 3% (v/v) bentonite powder from 0.0' to 10.0'.

Depth (ft)	Sample I.D. Sample Time	Sample Type	Graphic Log	USCS Code	Material Description	10.6 ev PID (ppm)	11.7 ev PID (ppm)	Backfill
1	SA129-3 16:31 SA129-4 16:37 SA129-5 13:44 SA129-6 13:51 SA129-7 13:57 SA129-8 17:00 SA129-9 17:05			SM	Silty sand (SM), dark yellowish brown (10YR 3/4), loose, dry. 5% fine gravel to 1", 70% fine to coarse sub-angular sand, 25% non-plastic fines, no odor or staining.			
2				ML				
3					Silty sand (SM), reddish brown (5YR 4/3), loose to medium-dense, dry. 5% fine gravel to 1", 75% fine to coarse sub-angular sand, 20% non-plastic fines, no odor or staining. @ 3' - 4' many clasts of indurated sediment, breaks easily by hand.		3.6	
4								
5				SM				
6							0.3	
7								
8							0.0	
9								
10								
11					Total depth 10.0'.			
12								
13								
14								
15								
16								
17								
18								
19								
20								
21								
22								
23								
24								
25								
26								
27								
28								
29								
30								
31								
32								
33								
34								

DRB-ENVIRO BORING 2027.01.GPJ 2/11/11

EXPLORATION LOG SA129-A2

PROJECT: TRONOX PHASE B
 EXPLORATION LOCATION: TRONOX AREA 2
 EXPLORATION SIZE (dia.): 3" CORE BARREL
 ELEVATION: EXISTING GROUND SURFACE

PROJECT NO.: 20092518V1
 EXPLORATION DATE: 9-21-2009
 EQUIPMENT: SDC550-24 SONIC CORE RIG
 LOGGED BY: SEARS/BRINKERHOFF

INITIAL DEPTH TO WATER: NOT ENCOUNTERED
 FINAL DEPTH TO WATER: NOT ENCOUNTERED

DATE MEASURED: N/A
 DATE MEASURED: N/A

ELEVATION/ DEPTH	SOIL & SAMPLE SYMBOLS	USCS	DESCRIPTION	PI	LL	MOISTURE CONTENT (%)	DRY DENSITY (pcf)	Pocket Penetrometer (tsf)	WELL CONSTRUCTION
		SP-SM	Silty SAND, yellowish brown (10YR 5/4), 35% silt, 65% fine to medium sand, trace gravel, loose, dry, strong HCl reaction						
		SP-SM	...4" thick ash layer, grey (10YR 6/1)						
		SP-SM	...weak to moderate cementation, slight chemical odor						
		SP-SM	Collect SA129-10B, PID readings: 10.6 eV = 0.3 ppmV, 11.7 eV = 1.3 ppmV						
		SP-SM	...gravel content increases to 10%						
		ML SP-SM	SILT with sand, light brown (7.5YR 6/3), 70% silt, 20% fine to medium sand, 10% fine to coarse gravel, dense, dry, strong HCl reaction Silty SAND, yellowish brown (10YR 5/4), 30% silt, 65% fine to medium sand, 5% fine to medium gravel, dense, dry, weak to moderate cementation, strong HCl reaction, slight chemical odor						

The descriptions contained within this exploration log apply only at the specific exploration location and at the time the exploration was made. It is not intended to be representative of subsurface conditions at other locations or times.

EXPLORATION LOG SA129-A2

PROJECT: TRONOX PHASE B
EXPLORATION LOCATION: TRONOX AREA 2
EXPLORATION SIZE (dia.): 3" CORE BARREL
ELEVATION: EXISTING GROUND SURFACE

PROJECT NO.: 20092518V1
EXPLORATION DATE: 9-21-2009
EQUIPMENT: SDC550-24 SONIC CORE RIG
LOGGED BY: SEARS/BRINKERHOFF

INITIAL DEPTH TO WATER: NOT ENCOUNTERED
FINAL DEPTH TO WATER: NOT ENCOUNTERED

DATE MEASURED: N/A
DATE MEASURED: N/A

ELEVATION/ DEPTH	SOIL & SAMPLE SYMBOLS	USCS	DESCRIPTION	PI	LL	MOISTURE CONTENT (%)	DRY DENSITY (pcf)	Pocket Penetrometer (tsf)	WELL CONSTRUCTION
		SP-SM	...color to brown (7.5YR 4/4)						
		SP-SM	Collect SA129-29B, PID readings: 10.6 eV = 0.3 ppmV, 11.7 eV = 0.0 ppmV						
			END OF BORING AT 30.5 FEET						

The descriptions contained within this exploration log apply only at the specific exploration location and at the time the exploration was made. It is not intended to be representative of subsurface conditions at other locations or times.

EXPLORATION LOG SA198-A2

PROJECT: TRONOX PHASE B
EXPLORATION LOCATION: TRONOX AREA 2
EXPLORATION SIZE (dia.): 3" CORE BARREL
ELEVATION: EXISTING GROUND SURFACE

PROJECT NO.: 20092518V1
EXPLORATION DATE: 8-20-2009
EQUIPMENT: SDC550-24 SONIC CORE RIG
LOGGED BY: SEARS/GAREY

INITIAL DEPTH TO WATER: NOT ENCOUNTERED
FINAL DEPTH TO WATER: NOT ENCOUNTERED

DATE MEASURED: N/A
DATE MEASURED: N/A

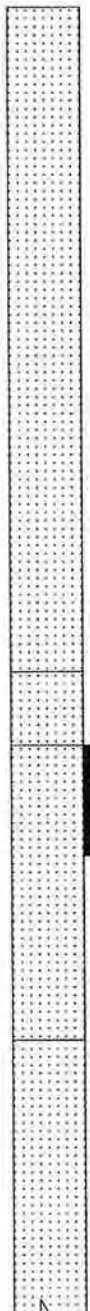
ELEVATION/ DEPTH	SOIL & SAMPLE SYMBOLS	USCS	DESCRIPTION	PI	LL	MOISTURE CONTENT (%)	DRY DENSITY (pcf)	Pocket Penetrometer (tsf)	WELL CONSTRUCTION
		SW	SAND, reddish brown (5YR 4/4), 95% fine to coarse sub-angular to sub-rounded sand, 5% fine to medium gravel, loose to dense, dry, weak to moderately cemented caliche zones, strong HCl reaction						
		SW	...gravel content to 10%						
	<div style="position: absolute; left: 250px; top: 660px; font-size: 8px;"> 40 45 30 </div>	SW	Collect SA198-10B, PID readings: 10.6 eV = 0.4 ppmV, 11.7 eV = 0.0 ppmV						
		SW	...gravel content to 15%						

The descriptions contained within this exploration log apply only at the specific exploration location and at the time the exploration was made. It is not intended to be representative of subsurface conditions at other locations or times.

EXPLORATION LOG SA198-A2

PROJECT: TRONOX PHASE B
 EXPLORATION LOCATION: TRONOX AREA 2
 EXPLORATION SIZE (dia.): 3" CORE BARREL
 ELEVATION: EXISTING GROUND SURFACE

PROJECT NO.: 20092518V1
 EXPLORATION DATE: 8-20-2009
 EQUIPMENT: SDC550-24 SONIC CORE RIG
 LOGGED BY: SEARS/GAREY

INITIAL DEPTH TO WATER: NOT ENCOUNTERED
 FINAL DEPTH TO WATER: NOT ENCOUNTERED

DATE MEASURED: N/A
 DATE MEASURED: N/A



ELEVATION/ DEPTH	SOIL & SAMPLE SYMBOLS	USCS	DESCRIPTION	PI	LL	MOISTURE CONTENT (%)	DRY DENSITY (pcf)	Pocket Penetrometer (tsf)	WELL CONSTRUCTION
20									
22.5		SW	...strong cementation (calcite cement)						
25		SM	Silty SAND, yellowish brown (10YR 5/6), 15% silt, 85% very fine to fine sand, loose, moist, low to medium plasticity, weak HCl reaction						
27.5		SM	Collect SA198-27B, PID readings: 10.6 eV = 2.1 ppmV, 11.7 eV = 0.3 ppmV						
			END OF BORING AT 28.5 FEET						
30									
32.5									
35									

The descriptions contained within this exploration log apply only at the specific exploration location and at the time the exploration was made. It is not intended to be representative of subsurface conditions at other locations or times.

Boring Log

Project Number: 2027.01		Boring No.: SSAM5-03	
Project Name: Tronox Phase B Investigation		Logged by: Eric Taub	
Drilling Contractor: Boart Longyear Company		Date Started: 05/04/10	Date Completed: 05/04/10
Drilling Method: Sonic		Total Depth (ft bgs): 11.0	Depth to Water (ft bgs):
Borehole Dia. (in): 6		Surface Elevation (ft MSL):	

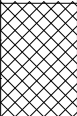
Remarks: Abandoned with neat cement grout containing 3% (v/v) bentonite powder from 0.0' to 11.0'.

Depth (ft)	Sample I.D. Sample Time	Sample Type	Graphic Log	USCS Code	Material Description	10.6 ev PID (ppm)	11.7 ev PID (ppm)	Backfill
1	SSAM5-03-1, SSAM5-03-1FD 14:40			Fill	Fill: poorly graded sand (SP), yellowish brown (10YR 5/4), loose to very loose, slightly moist. 5% fine sub-rounded gravel to 1/2", 90% fine to medium sub-angular sand, 5% nonplastic fines. Heavy staining and odor.			
2	SSAM5-03-2 14:50			SP	Poorly graded sand (SP): yellowish brown (10YR 5/4), loose to very loose, slightly moist. 5% fine sub-rounded gravel to 1/2", 90% fine to medium sub-angular sand, 5% nonplastic fines, no odor. Light staining.	3.0	2.2	
3	SSAM5-03-3 14:58							
4	SSAM5-03-4 15:03							
5	SSAM5-03-5 15:07							
6	SSAM5-03-6 15:12							
7	SSAM5-03-7 15:25							
8	SSAM5-03-8 15:41							
9	SSAM5-03-9 15:45							
10	SSAM5-03-10 15:50							
11								Total depth 11.0'.
12								
13								
14								
15								
16								
17								
18								
19								
20								
21								
22								
23								
24								
25								
26								
27								
28								
29								
30								
31								
32								
33								
34								

DRB-ENVIRO BORING 2027.01.GPJ 2/11/11

Appendix B

ENVIRON Standard Operating Procedures

Surface and Soil Excavation Sampling

April 22, 2014

ENVIRON International Corporation

TABLE OF CONTENTS

1. Purpose.....3

2. Equipment/Apparatus.....3

3. Decontamination Procedures.....4

 3.1 Decontamination Prior to Sampling.....4

 3.2 In-Field Sampling Decontamination Procedures.....4

4. Sample Collection.....4

 4.1 Discrete Soil Sampling Procedures.....4

 4.2 Composite Soil Sampling Procedures.....5

 4.3 VOC Sample Collection Procedures.....6

5. Sample Description and Field Documentation.....7

6. References.....7

1. Purpose

This standard operating procedure (SOP) is applicable to the collection of representative soil samples. This SOP is generic in nature and may be modified in whole or part to meet the handling and analytical requirements of the contaminants of concern, as well as the constraints presented by site conditions and equipment limitations. Modifications of sampling methodologies will be documented in the appropriate field logbook and discussed in reports summarizing field activities and analytical results. For the purposes of this procedure, soils are those mineral and organic materials not submerged in water for an extended period of time sufficient to support aquatic life, and surface soil is soil that can be collected from the ground surface or an excavation sidewall or bottom using hand-driven equipment such as scoops, hand augers, or soil recovery probes.

2. Equipment/Apparatus

Equipment needed for collection of soil samples may include:

- Maps/Plot plan
- Safety equipment
- Tape measure
- Survey stakes, flags,
- Camera
- Stainless steel, plastic, or other appropriate composition bucket or bowl
- 4-oz., 8-oz., one-quart, or other appropriately-sized wide mouth jars w/Teflon lined lids
- Ziploc plastic bags
- Logbook
- Sample jar labels
- Chain of Custody records, field data sheets
- Cooler(s)
- Ice
- Decontamination supplies/equipment
- Spade or shovel
- Spatula
- Scoop
- Trowel
- Soil Recovery Probe

3. Decontamination Procedures

3.1 Decontamination Prior to Sampling

Proper decontamination of sampling equipment is essential to minimize the possibility of cross-contamination of samples. Nondedicated equipment used for sampling various environmental media (soil, groundwater, surface water, etc.) will be cleaned before its initial use in the field and again before use at each subsequent sampling site.

All nondedicated sampling equipment will be new, or will be decontaminated prior to its initial use on-site. Decontamination procedures will include the following steps:

1. Wash the equipment in a nonphosphate detergent.
2. Rinse with potable tap water.
3. Rinse with deionized (DI) or distilled water.

To the extent practicable, single-use sampling equipment and materials will be used for the collection of all environmental samples. The materials used will be new and clean, and will be placed in plastic for transport to the site. Once used, this equipment will be placed in plastic bags and managed as investigation-derived waste material.

3.2 In-Field Sampling Decontamination Procedures

As described above, this sampling protocol describes multiple methods for soil sample collection. The decontamination procedures described below will be relied upon in the field as appropriate for equipment decontamination.

Nondedicated equipment that is to be used at additional locations at the site will be field-decontaminated between sampling locations. The field decontamination of sampling equipment will take place at the sampling location. All decontamination water will be contained in 5-gallon plastic buckets and combined with other decontamination wastewater.

If nondisposable, nondedicated field equipment is used, field equipment blanks will be collected at a rate specified in the Quality Assurance Project Plan.

4. Sample Collection

4.1 Discrete Soil Sampling Procedures

In general, discrete samples will be collected using a soil recovery probe with butyrate plastic liners, a hand auger, shovel, or scoop. Soil samples collected with a scoop, shovel, hand auger, or similar tool may be placed in a stainless steel (or other suitable material) bowl or bucket and homogenized. The soil recovery probe samplers are hand-pushed or driven and are capable of collecting a ¾-inch or 1-inch-diameter by 12-inch long sample. The sample enters directly into a butyrate liner, which is then removed from the sampler for processing. The sampler will attempt to sample soil that is not covered by standing water. However, if standing water is present in a sample location, an attempt will be made to minimize the amount of water in the sample by carefully draining off excess water from the sample tube, or after placing the sample in a mixing pan. Field staff will also take precautions to minimize the amount of grass,

roots, and rocks transferred into the sampling container. Sticks, stones, grass, and/or other debris will be removed from the sample. Excess soil will be returned to the sample location.

Each discrete sample will be described in the field notebook using the Unified Soil Classification System and its collection location flagged and photographed (if possible). Soil samples that will not become composite samples will be placed directly in the appropriate sample containers using a clean plastic or metal spatula, or by using a clean gloved hand. Samples that are collected for VOC analysis using bucket sampling will be taken from an intact portion of soil to minimize VOC loss.

Discrete samples that will become aliquots of a composite sample will be covered or capped as soon as possible after collection. Each butyrate tube or sample container will be labeled and stored on ice pending the composite process.

At locations where samples are to be obtained at depths greater than 1 foot, a 2-inch diameter (or larger) bucket auger or similar device will be used to reach the top of the intended sample interval. A sample will be collected either directly from the auger or a soil recovery probe sampler with butyrate liner will be lowered into the hole to the top of the sample interval and advanced to the intended sample depth.

4.2 Composite Soil Sampling Procedures

Composite samples will be prepared from the discrete samples following collection of the required number of discrete sample specified for the sampling area. Each discrete sample will be removed from its butyrate liner either using a stainless steel extruder, or by cutting the butyrate tube lengthwise and lifting or sliding the sample from the tube onto a clean sheet of aluminum foil; discrete samples collected by hand auger, scoop or other similar method will be removed from the sample container and placed on a clean sheet of aluminum foil. After removing sticks, grass, stones, and other debris, each discrete sample will be separated into quarters – cores will be cut lengthwise into 4 equal portions, while disturbed samples will be homogenized and divided. Three of the four quarters of each sample will then be placed into one of three individual foil pans. The fourth portion of the discrete sample will be placed in a plastic baggie, labeled, sealed, and stored separately for potential individual analysis.

The compositing process of quartering discrete samples will be repeated for successive discrete samples until each of the three pans contains one quarter of each discrete sample. The contents of each aluminum foil pan will then be thoroughly mixed either by hand or by using an electrical or mechanical mixer. Upon completion of the mixing process, the contents of each individual pan will then be combined into one clean pan and again thoroughly mixed, resulting in one homogeneous sample. The composite soil sample will then be placed in the appropriate sample containers, labeled, and placed on ice pending shipment to the laboratory.

4.3 VOC Sample Collection Procedures

Soil samples obtained for laboratory analysis of VOCs will be collected in compliance with SW-

846 Method 5035. Each soil sample will be obtained directly from the sampling device (i.e., not homogenized) using an EnCore™ sampler or field preserved using Method 5035 compatible containers. A description of each sampling procedure is as follows:

EnCore Sampler

The EnCore™ sampler is a single use, commercially available device constructed of an inert composite polymer. EnCore™ uses a coring/storage chamber to collect either a 5-gram or 25-gram sample of cohesive soils. It has a press-on cap with a hermetically vapor tight seal and a locking arm mechanism. Three EnCore™ samplers shall be filled at each sample location using the following procedures:

- Place the EnCore™ sampler into the EnCore™ T-Handle tool.
- Push the sampler into the soil sample until the small o-ring on the plunger of the EnCore™ sampler is visible in the T-Handle viewing hole.
- Wipe off any excess soil from the coring body exterior using a clean paper towel.
- Place the cap on the end of the EnCore™ sampler and twist to lock the cap into place.
- Remove the sampler from the T-Handle and lock the plunger by rotating extended plunger rod fully counterclockwise until the plunger wings rest firmly against the plunger tabs.
- Place the label on the sampler and place the sampling into a labeled EnCore™ sampler bag and zip closed.
- Place the filled EnCore™ samplers in a cooler with ice for overnight shipment to the laboratory using standard chain-of-custody procedures. The soil samples must be prepared for analysis or frozen within 48 hours of sample collection.

Field Preservation

The procedures for the field preservation method are as follows:

- Push a one-time use plastic sampling tool such as a Terra Core™ sampler into the soil to be samples to collect an approximately 5-gram sample aliquot.
- Transfer the 5-gram aliquot to laboratory provided, pre-preserved, 40-milliliter vials containing a specific amount of methanol, sodium bisulfate, and/or organic-free water. The number of vials provided with each preservative will vary by the laboratory performing the analysis. One unpreserved container shall also be filled to allow for laboratory calculation of the sample dry weight.
- Label each sample and place in a cooler with ice for overnight shipment to the laboratory using standard chain-of-custody procedures.

5. Sample Description and Field Documentation

After samples for chemical and physical analysis have been prepared, a visual soil or lithologic

description of each sample will be made according to the Unified Soil Classification System (USCS), and will be recorded in a bound log notebook. Each sampling location will be photographed, and the approximate location will be placed on a site map and recorded in the field notebook.

Residual soil from the compositing process and stored individual discrete sample portions will be disposed in accordance with the Sampling and Analysis Plan.

6. References

ENVIRON. 2014. Sampling and Analysis Plan, Nevada Environmental Response Trust, Henderson, Nevada. January 24.

United States Environmental Protection Agency. 1996. Method 5035: Closed-System Purge-and-Trap and Extraction for Volatile Organics in Soil and Waste Samples. December.

Soil Sampling with Direct-Push or Hollow-Stem Auger Samplers

April 22, 2014

ENVIRON International Corporation

TABLE OF CONTENTS

1. Purpose.....3

2. Sample Collection.....3

 2.1 Discrete Soil Sampling Procedures.....3

 2.2 Composite Soil Sampling Procedures.....3

 2.3 VOC Sample Collection Procedures.....4

3 Sample Description and Field Documentation.....5

4 Equipment Decontamination.....5

5 References.....6

1. Purpose

This standard operating procedure (SOP) is applicable to the collection of representative soil samples using a direct-push or hollow-stem auger sampling technique. The methodologies discussed in this SOP are generic in nature and may be modified in whole or part to meet the handling and analytical requirements of the contaminants of concern, as well as the constraints presented by site conditions and equipment limitations. Modifications of sampling methodologies will be documented in the appropriate field logbook and discussed in reports summarizing field activities and analytical results. For the purposes of this procedure, soils are those mineral and organic materials not submerged in water for an extended period of time sufficient to support aquatic life.

2. Sample Collection

The primary means for the collection of subsurface soil samples will be a direct-push technique using a Geoprobe[®] or equivalent driver. Direct-push soil samples will be obtained using a closed-piston soil sampler with a liner (or equivalent sampling system). If needed, a hollow-stem auger sampler may be used to collect soil samples. The sampler will be operated in accordance with the manufacturer's recommended operating procedures for the type of equipment used.

2.1 Discrete Soil Sampling Procedures

Soil samples will be collected at predetermined intervals based on specific data needs. Each discrete sample will be described in the field notebook using the Unified Soil Classification System (USCS) as described below. Soil samples that will not become composite samples will be placed directly in the appropriate sample containers using a clean plastic or metal spatula, or by using a clean gloved hand.

Subsamples selected for laboratory analysis will be placed in appropriate sample containers provided by the analytical laboratory, labeled, placed in an iced cooler, and stored in accordance with chain-of-custody requirements specified in the Quality Assurance Project Plan (QAPP) until shipment to the laboratory (or laboratories) is arranged. Chain-of-custody records will be completed for all samples according to the methods described in the QAPP.

Discrete samples that will become aliquots of a composite sample will be covered or capped as soon as possible after collection if the compositing process is not completed immediately. Each sample container will be labeled and stored on ice pending the composite process.

2.2 Composite Soil Sampling Procedures

Composite samples will be prepared from the discrete samples following collection of the required number of discrete sample specified for the sampling area. Each discrete sample will be removed from the sample container and placed on a clean sheet of aluminum foil. After removing sticks, grass, stones, and other debris, each discrete sample will be separated into quarters – cores will be cut lengthwise into 4 equal portions, while disturbed samples will be homogenized and divided. Three of the four quarters of each sample will then be placed into

one of three individual foil pans. The fourth portion of the discrete sample will be placed in a plastic baggie, labeled, sealed, and stored separately for potential individual analysis.

The compositing process of quartering discrete samples will be repeated for successive discrete samples until each of the three pans contains one quarter of each discrete sample. The contents of each aluminum foil pan will then be thoroughly mixed either by hand or by using an electrical or mechanical mixer. Upon completion of the mixing process, the contents of each individual pan will then be combined into one clean pan and again thoroughly mixed, resulting in one homogeneous sample. The composite soil sample will then be placed in the appropriate sample containers, labeled, and placed on ice pending shipment to the laboratory.

2.3 VOC Sample Collection Procedures

Soil samples obtained for laboratory analysis of VOCs will be collected in compliance with SW-846 Method 5035. Each soil sample will be obtained directly from the sampling device (i.e., not homogenized) using an EnCore™ sampler or field preserved using Method 5035 compatible containers. A description of each sampling procedure is as follows:

EnCore Sampler

The EnCore™ sampler is a single use, commercially available device constructed of an inert composite polymer. EnCore™ uses a coring/storage chamber to collect either a 5-gram or 25-gram sample of cohesive soils. It has a press-on cap with a hermetically vapor tight seal and a locking arm mechanism. Three EnCore™ samplers shall be filled at each sample location using the following procedures:

- Place the EnCore™ sampler into the EnCore™ T-Handle tool.
- Push the sampler into the soil sample until the small o-ring on the plunger of the EnCore™ sampler is visible in the T-Handle viewing hole.
- Wipe off any excess soil from the coring body exterior using a clean paper towel.
- Place the cap on the end of the EnCore™ sampler and twist to lock the cap into place.
- Remove the sampler from the T-Handle and lock the plunger by rotating extended plunger rod fully counterclockwise until the plunger wings rest firmly against the plunger tabs.
- Place the label on the sampler and place the sampling into a labeled EnCore™ sampler bag and zip closed.
- Place the filled EnCore™ samplers in a cooler with ice for overnight shipment to the laboratory using standard chain-of-custody procedures. The soil samples must be prepared for analysis or frozen within 48 hours of sample collection.

Field Preservation

The procedures for the field preservation method are as follows:

- Push a one-time use plastic sampling tool such as a Terra Core™ sampler into the soil to be samples to collect an approximately 5-gram sample aliquot.

- Transfer the 5-gram aliquot to laboratory provided, pre-preserved, 40-milliliter vials containing a specific amount of methanol, sodium bisulfate, and/or organic-free water. The number of vials provided with each preservative will vary by the laboratory performing the analysis. One unpreserved container shall also be filled to allow for laboratory calculation of the sample dry weight.
- Label each sample and place in a cooler with ice for overnight shipment to the laboratory using standard chain-of-custody procedures.

3 Sample Description and Field Documentation

After samples for chemical and physical analysis have been prepared, a visual soil or lithologic description of each sample will be made according to the USCS, and will be recorded in a bound log notebook. Each sampling location will be photographed, and the approximate location will be placed on a site map and recorded in the field notebook.

Residual soil from the compositing process and stored individual discrete sample portions will be disposed in accordance with the Sampling and Analysis Plan.

4 Equipment Decontamination

Drilling and support equipment will not come in direct contact with the samples, so cross-contamination of samples is not a concern. However, this equipment will likely come in contact with impacted soil and must therefore be decontaminated prior to moving from one location to another.

The drilling equipment used for soil sampling and monitoring well installation will be cleaned with high-pressure/hot water washing equipment prior to initiating the field investigation. The same procedure will be applied to all drilling equipment between each boring location. The cleaning will occur at a decontamination pad constructed at a suitable location(s) at the site. Water used for cleaning will be obtained from a local potable water source. Equipment subject to these decontamination procedures includes, but is not limited to, the following:

- Direct-push or hollow-stem auger drill rig.
- Direct-push or hollow-stem auger sampler components.

In addition, downhole equipment that comes in direct contact with samples will be decontaminated between each sample interval. This procedure will include washing with a nonphosphate detergent and rinsing with clean potable water.

If required, a piece of sampling equipment that comes in direct contact with soil samples (e.g., split-barrel samplers) will be selected for collection of field equipment blanks. After the equipment has been cleaned, it will be rinsed with DI water. The rinse water will be collected and submitted for analysis of all constituents for which the normal samples collected with the equipment are being analyzed.

Field blanks will be collected at the frequency specified in the QAPP.

5 References

ENVIRON. 2014. Quality Assurance Project Plan, Nevada Environmental Response Trust, Henderson, Nevada. January 24.

United States Environmental Protection Agency. 1996. Method 5035: Closed-System Purge-and-Trap and Extraction for Volatile Organics in Soil and Waste Samples. December.

Monitoring Well Installation and Development

April 22, 2014

ENVIRON International Corporation

TABLE OF CONTENTS

1. Purpose.....3

2. Well Installation.....3

3. Filter Material.....3

4. Setting Wells.....3

5. Well Completion.....3

6. Development and Surveying.....4

7. Decontamination of Drilling Equipment.....4

8. Documentation.....4

9. References.....4

1. Purpose

This standard operating procedure (SOP) is applicable to the installation and development of wells for groundwater monitoring or remediation purposes. This SOP is generic in nature and may be modified in whole or part depending on constraints presented by site conditions and equipment limitations. Modifications of methodologies will be documented in the appropriate field logbook and discussed in reports summarizing field activities. The procedures herein were prepared in accordance with applicable sections of Chapter 534 of the Nevada Administrative Code.

2. Well Installation

Prior to invasive activities, a subsurface utility check will be conducted. Wells will generally be constructed using 5- to 20-foot-long screen and sufficient riser to complete the well to, or slightly above, ground surface. The length of the well screen will be selected based on the planned use of each well and the observed lithology. Wells will be constructed using schedule 40 polyvinyl chloride (PVC) casing and 0.010 slot schedule 40 PVC well screen with a threaded bottom cap. Wells will generally be completed with a protective steel cover extending a minimum of 18 inches above the finished grade and a minimum of 5 feet below the seal. The protective cover will be equipped with a lock to protect the well against damage and unauthorized entry.

3. Filter Material

Filter material will be well-graded, clean sand (generally less than 2-percent by weight passing a No. 200 sieve and less than 5 percent by weight of calcareous material).

4. Setting Wells

Upon completion of borehole drilling, the boring will be sounded to determine the total depth, and the PVC well materials will be assembled and lowered into the boring. PVC well materials will be measured to the nearest 0.1 foot and will be assembled such that the screened interval is positioned opposite the target formation. No PVC cement or other solvents will be used. Once the well has been positioned at the desired depth, filter sand will be slowly added to the borehole to fill the annular space to a depth approximately 1 to 2 feet above the top of the well screen. During sand placement, the driller will continually measure the depth to the sand using a weighted tape measure or other device to verify that the sand does not bridge between the auger and the well screen. A minimum of two feet of bentonite chips will be added on top of the filter sand and subsequently hydrated using clean, municipal water to form a transition seal. After the bentonite has hydrated for at least 30 minutes, the depth to the top of the bentonite will be measured and recorded. A neat cement/bentonite grout will be added from the top of the bentonite; a tremie pipe will be utilized to ensure that the grout is added from the bottom, upwards. The grout will be permitted to cure for 48 hours prior to well development.

5. Well Completion

All monitoring wells and monitoring points will be completed with a protective steel cover equipped with a lock to protect the well against damage and unauthorized entry. Wells will typically be completed above grade unless they are located within parking/driving areas, or are piped to a remediation system. Wells completed aboveground will be capped with a push-on well cap and completed with a steel stick-up casing extending at least one foot above the surface pad. Wells completed below ground surface will be capped with an expandable locking

well cap and completed with a flush mounted traffic rated steel cover set into a 2 foot by 2 foot concrete pad, expending one-half inch above the surface concrete or asphalt. All wells will be labeled with a permanent marker that includes the well ID.

6. Development and Surveying

New wells will be developed after the grout has cured for a minimum of 48 hours. Wells will be developed by surging, bailing, and pumping to reduce or remove drilling-induced formation smear from the borehole walls, to remove sediment that may have accumulated during well installation, consolidate the filter pack, and to enhance the hydraulic connection between the formation target zone and the well. In most cases, a bailer or pump will be used to remove sediment and turbid water from the bottom of the well. A surge block will then be lowered up and down within the screened interval to flush the filter pack of fine sediment and remove smear from borehole walls. Following surging, the well will be bailed or pumped again to remove sediment and turbid water. Water will be removed from the well at a rate greater than the anticipated future pumping rate and water quality parameters including pH, turbidity, specific conductance and temperature will be recorded. Drawdown will also be recorded with an interface probe or water level meter. The development will proceed until sediment is removed sufficiently to achieve a turbidity measurement of 5 NTU (or less). The well installation report will specify if the target turbidity cannot be achieved.

Following well installation and completion, each well will be surveyed by a licensed surveyor to determine the location of the well and to establish the elevation at the top of casing and ground surface with reference to the site datum. Survey data will be incorporated into the database and onto the site base map.

7. Decontamination of Drilling Equipment

All drilling and well development equipment will be cleaned prior to use, and between wells. Drilling equipment will be steam cleaned, rinsed with potable water, and air dried. If equipment is not immediately put back to use, equipment will be covered with clean plastic to protect the materials from contact with dust or other contaminants. Pumps or other non-dedicated field equipment that comes into contact with impacted media will be cleaned using a non-phosphate detergent followed by a tap water rinse and a final, deionized water rinse. Decontamination water will be collected for appropriate, subsequent off-site disposal. Spent PPE or other disposable materials (e.g., tubing) will be placed into a drum for subsequent disposal.

8. Documentation

Well installation and construction activities will be recorded in the field notebook. A well construction diagram will be completed for each well, reviewed by appropriate personnel for completeness and accuracy, and filed electronically in the project file. The CQA Officer will complete and submit an Well Completion form for each well.

9. References

ENVIRON. 2014. Quality Assurance Project Plan, Nevada Environmental Response Trust, Henderson, Nevada. January 24.
Nevada Division of Environmental Protection. 2012. Nevada Administrative Code, Chapter 534 – Underground Water and Wells. June.

Photoionization Detector (PID) Screening

April 22, 2014

ENVIRON International Corporation

TABLE OF CONTENTS

1. Purpose.....3

2. Equipment/Apparatus.....3

3. Procedure.....3

4. References.....4

1. Purpose

This standard operating procedure (SOP) is applicable to the use of a photoionization detector/flame ionization detector (PID/FID) instrument during soil sampling activities. The methodology is generic in nature and may be modified in whole or part to meet the handling and analytical requirements of the contaminants of concern, as well as the constraints presented by site conditions and equipment limitations. Modifications of sampling methodologies will be documented in the appropriate field logbook and discussed in reports summarizing field activities and analytical results. For the purposes of this procedure, soils are those mineral and organic materials not submerged in water for an extended period of time sufficient to support aquatic life.

2. Equipment/Apparatus

Equipment needed for PID/FID screening of soil samples may include:

- PID/FID instrument
- Clear glass jar
- Aluminum foil
- Ziploc bags

3. Procedure

When using PID/FID instrument the following procedure must be used:

- Half-fill **either** a glass jar, or a Ziploc® baggie.
 - When using glass jars:
 - Fill jars with a total capacity of 8 oz. or 16 oz.
 - Seal each jar with one (1) or two (2) sheets of aluminum foil with the screw cap applied to secure the aluminum foil.
 - When using Ziploc® baggies:
 - Half fill bags from the split spoon or the excavation.
 - Zip to close.
- Vigorously shake the sample jars or bags for at least thirty (30) seconds once or twice in a 10- to 15-minute period to allow for headspace development.
- If ambient temperatures are below 32 degrees Fahrenheit (0 degrees Celsius) headspace development is to be within a heated vehicle or building.
- Quickly insert the PID/FID sampling probe through the aluminum foil. If plastic bags are used, unzip the corner of the bag approximately one to two inches and insert the probe or insert the probe through the plastic. Record the maximum meter response (should be within the first 2 to 5 seconds). Erratic responses should be discounted as a result of high organic vapor concentrations or conditions of elevated headspace moisture.
- Record headspace screening data from both jars or bags for comparison.

- Calibration will be checked/adjusted daily. In addition, all manufacturers' requirements for instrument calibration will be followed.
- If sample jars are re-used in the field, jars will be cleaned according to field decontamination procedures. In addition, headspace readings must be taken to ensure no residual organic vapors exist in the cleaned sample jars.
- Plastic bags will not be reused.

4. References

ENVIRON. 2014. Quality Assurance Project Plan, Nevada Environmental Response Trust, Henderson, Nevada. January 24.

Determining Hydraulic Conductivity Using an Aardvark Permeameter

April 22, 2014

**Soil Moisture Equipment Corporation
ENVIRON International Corporation**

Attachment:

Soilmoisture Equipment Corp. 2011. 2840 Operating Instructions Aardvark Permeameter.
December. (36 pages)

TABLE OF CONTENTS

1. Purpose.....3
2. Applicability.....3
3. Definitions.....3
4. Responsibility.....3
5. Equipment and Materials.....3
6. Procedure.....4
7. References.....5

Attachments:

Soil Moisture Equipment Corporation, December 2011. 2840 Operating Instructions:
Aardvark Permeameter. (36 pages)

1. Purpose

This Technical Procedure is to be used to establish a uniform procedure for executing a permeameter test.

2. Applicability

This Technical Produce is applicable to all persons or parties involved with permeameter testing using an Aardvark Permeameter.

3. Definitions

3.1 Saturated hydraulic conductivity (K_{sat}): An indicator of water flow rate in soil and is a key parameter for studying water flow and chemical transport through a soil profile.

3.2 Constant-head permeameter: Tool which measures soil-water infiltration rate by maintaining a constant depth of water in the borehole during the measurement period and measuring the rate of water supplied by the reservoir.

4. Responsibility

4.1 Field Personnel performing permeameter testing shall be responsible for the proceeding with testing in compliance with this technical procedure.

4.2 Task Leader shall be responsible for:

- Direct supervision of personnel performing the test.
- Assurance that equipment and materials are available to permit accomplishment of the task.
- Determine appropriate time intervals between readings.

5. Equipment and Materials

5.1 Field notebook.

5.2 Model 2840K1PC & 2840K2PC Automated Aardvark Permeameter kits for shallow and deep measurements (>3.44 meters), respectively.

5.3 Field datasheets for manually recorded readings.

6. Procedure

6.1 Perform site evaluation and select number and location of areas that are representative of the soils being tested.

6.2 Prepare the borehole(s) with suggested diameter of 10 centimeters (4

- inches) with depths ranging from 20 centimeters (7.9 inches) to 15 meters (50 feet).
- 6.3 Assemble the Aardvark Permeameter Module (APM) and Reservoir Unit (RU) (as needed), along with the reservoir, scale, table, and tubing setup according to the instructions in the document *2840 Operating Instructions: Aardvark Permeameter*, pages 22.
 - 6.4 Install the APM in the borehole by lowering it into the borehole using the tape, making sure that it is touching the bottom of the borehole. Secure the tape using the tape holder and tubing, being sure to never let the tubing hanging directly from the Reservoir Valve.
 - 6.5 Determine and record the following parameters: depth of the borehole; height of the Reservoir from soil surface; vertical distance between the APM Floating Valve and Reservoir (parameter D).
 - 6.6 Fill out the upper section of the data sheet; record initial water level/volume in the Reservoir and the time in the first row of the table.
 - 6.7 Open the reservoir valve, establishing a constant water head. Record Reservoir water level and time after appropriate interval, as determined by information found in the document *2840 Operating Instructions: Aardvark Permeameter*, page 20.
 - 6.8 Add more water to the Reservoir, if needed. Record Reservoir water level and time right before and after refilling.
 - 6.9 Monitor the Steady Water Consumption Rate (R) being calculated via the SimplyDATA Software Suite application. If not using the software, the Steady Water Consumption Rate can be determined using the formula found in the document *2840 Operating Instructions: Aardvark Permeameter*, page 20. The measurement is complete when the Water Consumption Rate does not change over several consecutive readings. In the Steady Water Consumption Rate stage, the steady "Water Consumption Rate" is equivalent to the soil Steady Flow Rate (Q) or Soil-Water Stead Infiltration Rate, which is the key parameter to calculate saturated hydraulic conductivity.
 - 6.10 Utilize the SimplyDATA Software Suite to perform all the measurements and calculations for saturated hydraulic conductivity automatically, referring to the "SimplyDATA Software Suite Operating Instructions" for more details. The calculations can also be performed manually according to the instructions on pages 31-33 of the document *2840 Operating Instructions: Aardvark Permeameter*.

7. References

ENVIRON. 2014. Quality Assurance Project Plan, Nevada Environmental Response Trust, Henderson, Nevada. January 24.

Soil Moisture Equipment Corporation. 2011. 2840 Operating Instructions: Aardvark Permeameter. December.

2840

OPERATING INSTRUCTIONS

Aardvark Permeameter

December 2011

Model 2840K2 Series

Manual Aardvark Measurements
(0.2 ml accuracy, 50 ft operating depth)



2840K2 Aardvark Kit complete in case

Model 2840K2RIF & PC Series

Automated Aardvark Measurements
(0.2 ml accuracy, 50 ft operating depth)



2840K2RIF Aardvark Kit complete in case

Models 2840K1 and 2840K2 for Quick and Easy K_{sat} Measurements

The Aardvark Permeameter is an easy to use instrument to quickly and accurately measure in-situ saturated water flow. Accurate evaluation of soil hydraulic conductivity and matrix flux potential can be made in almost all types of soils.

Model 2840K#PC and 2840K#RIF for Automated K_{sat} Measurements (#: 1 or 2)

If you purchased the PC or RIF Kit, this will help automate taking K_{sat} readings with the addition of a digital scale 7201W10, either a user-supplied PC or Soilmoisture's Record It in a Flash (RIF) unit.

Table of Contents

UNPACKING	3
CAUTIONS & WARNINGS	3
WARRANTY & LIABILITY	3
ACQUAINT YOURSELF WITH THE PARTS	4
Models 2840K1 & 2840K2 Aardvark Permeameter - For Quick and Easy K_{sat} Measurements	4
Models 2840K1PC & 2840K2PC Automated Aardvark Permeameter	5
Model 2840K1RIF & 2840K2RIF Automated Aardvark Permeameter with "Record It in a Flash" (RIF)	6
AARDVARK GENERAL SPECIFICATIONS	7
THEORY OF OPERATION and DEFINITIONS	8
REQUIREMENTS PRIOR TO USE	9
Operating Model 2840K1 and Model 2840K2 (Quick and Easy)	11
Aardvark Pressure Regulator Unit	11
Components of the Aardvark Permeameter Module (APM)	11
Assembly of your Reservoir Unit	12
Assembling Aardvark Table	12
Placement of Table	13
Connecting Tubing and Suspension Line to APM	13
Installing APM in Borehole	15
Documentation Prior to Performing a Measurement	19
Making a Reading	20
Operating Model 2840K1PC and Model 2840K2PC (automated readings using a PC)	22
Making a Reading	24
Operating Model 2840K1RIF and Model 2840K2RIF (for automated measurements)	25
Making a Reading	25
USEFUL HINTS DURING NORMAL USE	26
TROUBLESHOOTING	27
GENERAL CARE AND MAINTENANCE	28
Disassembling the Aardvark Permeameter Module	28
Cleaning the Aardvark Permeameter Module	28



USE AND APPLICATION OF PRODUCT OPTIONS	29
CALCULATIONS AND APPLICATIONS	31
Using SimplyDATA Software Suite for manually recorded data	31
Manually Performing the Calculations	32
REPLACEMENT PARTS LIST	35
APPENDIX A	36



UNPACKING

The Aardvark Permeameter Kit was thoroughly tested before shipment. When packed, it was in perfect working order. Unpack with care making sure you remove all packing material. Follow the instructions carefully in order to assure long, trouble-free service.

Any damage found upon receipt should be reported immediately to the transport carrier for claim. It is important to save the shipping container and all evidence to support your claim. Be sure to read all operating instructions thoroughly before operating the unit.

CAUTIONS & WARNINGS

In order to avoid damage to the device and injury, use only those tools included. When completely full, the water container is relatively heavy and additional weight should be taken into account. In order to prevent damage to scale or other parts of the system, make sure that the table is placed on a stable hard surface. Do not use larger volume water containers or replacement containers other than those supplied with your unit.

WARRANTY & LIABILITY

Soilmoisture Equipment Corp. (SEC) warrants all products manufactured by SEC to be free from defects in materials and workmanship under normal use and service for twelve (12) months from the date of invoice provided the section below has been met.

Soilmoisture Equipment Corp. (SEC) is not liable for any damages, actual or inferred, caused by misuse or improper handling of its products. SEC products are designed to be used solely as described in these product operating instructions by a prudent individual under normal operating conditions in applications intended for use by this product.



ACQUAINT YOURSELF WITH THE PARTS

Model 2840K1 & 2840K2 Aardvark Permeameter - For Quick and Easy K_{sat} Measurements

The Aardvark Permeameter Kit (2840K1 for measurements shallower than 3 m (11 ft) and 2840K2 for measurements deeper than 3 m) has everything needed for conducting the measurement and is simple to install and use. Since it has no electronic parts, it can be used everywhere from laboratories to remote areas. At the same time, the kit can be used with a personal computer (not included) and using the SimplyData Software Suite, there would be no need for manually calculating the parameters.

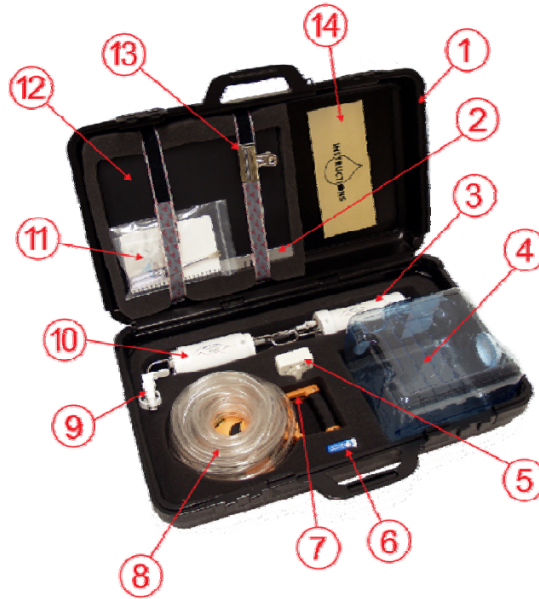

Fig. 1. Illustration of 2840K1 / 2840K2 components

- | | |
|--|--|
| 1. Aardvark Carrying Case | 8. Connecting Tube, 15 m (50 ft) |
| 2. Tape Holder | 9. Reservoir Outlet Assembly |
| 3. Aardvark Permeameter Module | 10. Aardvark Pressure Regulator Unit (not included in 2840K1). |
| 4. Aardvark Reservoir | 11. Support Package |
| 5. Countdown Timer | 12. Aardvark Table |
| 6. Flash drive loaded with SimplyData Software Suite | 13. Tubing Clip |
| 7. Measuring / Suspension line, 15 m (50 ft) | 14. Operating Instructions |



Aardvark Support Package

1. Hose Clamp
2. SEC 2 Color Pen
3. SEC LED Flash Light
4. Tubing Clip
5. Pin Access Tool
6. Silicon Grease
7. Quick Connection Insert
8. Tubing Barbed Connector
9. Plastic Connection Pin
10. SEC All Weather Notebook
11. SEC Measuring Tape

Model 2840K1PC & 2840K2PC Automated Aardvark Permeameter

These kits consist of an Aardvark Permeameter Kit (2840K1 for measurements shallower than 3 m (11 ft) or 2840K2 for measurements deeper than 3 m) and a Digital Scale (7201W10) which can be connected to a personal computer (not included) and record the measurements automatically and accurately, using the SimplyData Software Suite. There is no need to manually record data or perform the calculations. It is also possible to view the real-time graph of soil-water flux rate during the measurement period. This kit is a perfect option for laboratory experiments where it can easily be connected to a personal computer. It can also be used in the field using a portable laptop computer. This model can even be used to take manual readings (when no PC is available). Using the digital scale significantly adds to the accuracy of readings.



Fig. 2. Photo of 2840K1PC / 2840K2PC

- | | |
|-----------------------------|---|
| 1. Aardvark Permeameter Kit | 4. SimplyData Digital Scale |
| 2. Scale Carrying Case | 5. Scale Power Supply (not shown) |
| 3. USB Cable | 6. Scale Operating Instructions (not shown) |

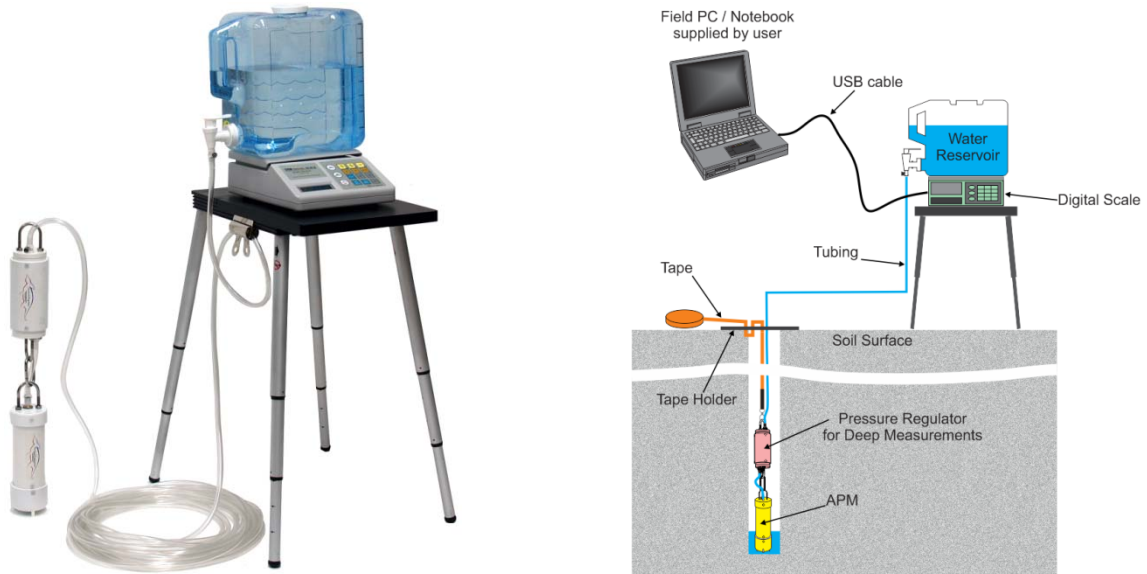

Fig. 3. Right: Model 2840K2PC. Left: Illustration of the model components: a USB cable connects the Digital Scale to a PC (not included). Real time graphs and calculations and data logging are the main features of SimplyData Software Suite installed on your PC. The kit also can be used without a PC (manual data recording and calculation).

Model 2840K1RIF & 2840K2RIF Automated Aardvark with "Record It in a Flash" (RIF)

Record It in a Flash (RIF) is the answer to the common cases when an accurate and automated permeameter is needed for use in outdoor conditions or remote areas and it is not convenient to use a PC. The kit consists of an Aardvark Permeameter Kit (2840K1 for measurements shallower than 3 m (11 ft) or 2840K2 for measurements deeper than 3 m) a Digital Scale (7201W10) that connects to an RIF Unit (7205) which eliminates the need for a dedicated personal computer. Record It in a Flash automatically records the Digital Scale measurements and performs the calculations. It also recognizes the end of the measurement period and alerts the user. The data can be transferred later to a PC or with the SimplyData Software Suite it is easy to manage the data files and generate graphs.



Fig. 4. Photo of 2840K1RIF (10 ft operating depth) or 2840K2RIF (50 ft operating depth) components.

- | | |
|---|-------------------------------------|
| 1. Aardvark Permeameter Kit (2840K1 for 2840K1RIF and 2840K2 for 2840K2RIF) | 4. RIF Carrying Case |
| 2. Digital Scale Package | 5. Four "C" size Alkaline batteries |
| 3. Record It in a Flash unit | 6. Digital Scale Power Supply |

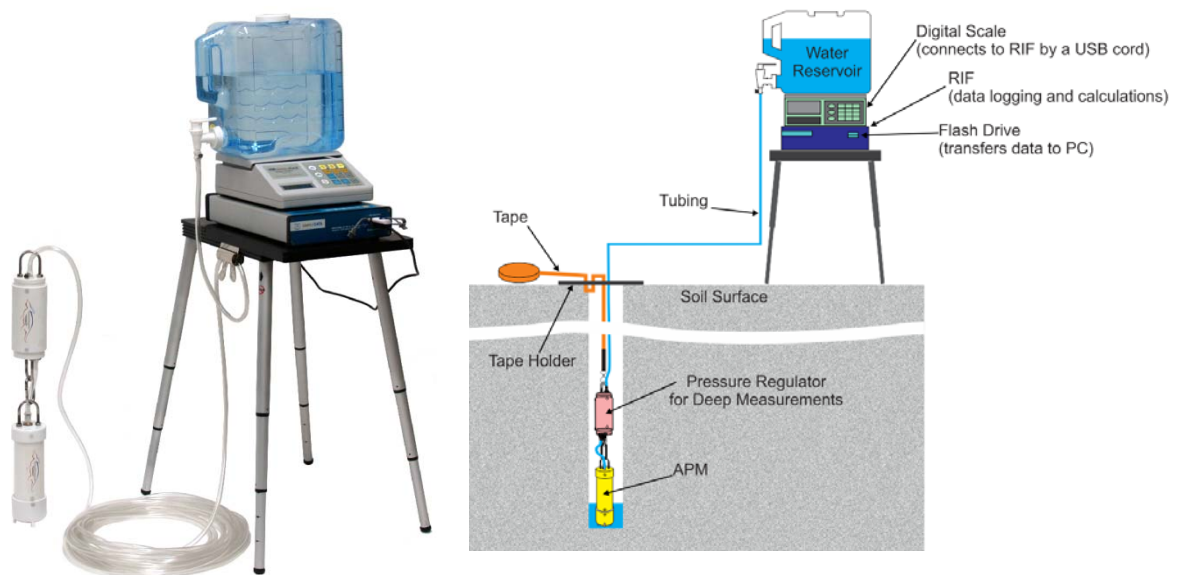

Fig. 5. Right: Model 2840K2RIF Setup. Left: Illustration of the model components. RIF logs the data received from Digital Scale. It uses this data to calculate K_{sat} coefficient and other related values. RIF also supplies the Scale power.

AARDVARK GENERAL SPECIFICATIONS

2840 Aardvark-1000 Permeameter Unit (comes in 2840K1, 2840K2, 2840K1PC, 2840K2PC, 2840K1RIF and 2840K2RIF)

Diameter (OD x L): 7.6 x 35.6 cm (3" x 14")
Minimum water supply rate (with 3 ft of water overhead pressure): 1000 ml / min (0.26 gal / min)
Maximum operational depth 15 m (50 ft)

2841V2.0 Aardvark Reservoir (comes in 2840K1, 2840K2, 2840K1PC, 2840K2PC, 2840K1RIF and 2840K2RIF)

Volume: 8 liter (2 gal) weight when full about 8 Kg (17.6 lbs.)
Dimensions (L x W x H): 25 x 18 x 23 cm (10" x 7" x 9")

2842 Aardvark Table (comes in 2840K1, 2840K2, 2840K1PC, 2840K2PC, 2840K1RIF and 2840K2RIF)

Table Top Dimensions (L x W): 38 x 26 cm (15" x 10½")
Height: from 33 to 73 cm (13" to 29")

2843 Aardvark Carrying Case (comes in 2840K1, 2840K2, 2840K1PC, 2840K2PC, 2840K1RIF and 2840K2RIF)

Dimensions (L x W x H): 71 x 43 x 18 cm (28" x 17" x 7")
Weight When Full: 6.6 Kg (14.6 lbs.)

7201W10 10Kg Digital USB Scale (comes in 2840K1PC, 2840K2PC, 2840K1RIF and 2840K2RIF)

Maximum load: 10 Kg
Resolution: 0.2 g
Dimensions (L x W x H): 26.4 x 20.1 x 7.9 cm (10.4" x 7.9" x 3.1")
Platform Size: 5.7" x 7.5"
Weight 1.05 Kg (2.3 lbs.)
Power Consumption: 0.035 W

7205 Record It in a Flash (RIF) unit (comes in 2840K1, 2840K2, 2840K1PC, 2840K2PC, 2840K1RIF and 2840K2RIF)

Dimensions (L x W x H): 35.6 x 21.6 x 5.1 cm (14" x 8.5" x 2")
Weight: 1.65 Kg (3.6 lbs.)
Max. Power Consumption: 0.8 W
Batteries: 4 'C'-size Alkaline
AC-DC Wall Adapter: 6VDC @ 1A, positive center

8010SFAGB02 SimplyData Software Suite (comes in 2840K1, 2840K2, 2840K1PC, 2840K2PC, 2840K1RIF and 2840K2RIF)

System requirements:
Windows 2000 or newer,
Minimum display resolution of 1024x768 and
.NET Framework (included in Windows Vista and newer)

2840-2000 Aardvark Regulator Unit (comes in 2840K2, 2840K2PC and 2840K2RIF)

Maximum operating range: 34 KPa (5 PSI)
Minimum operating range: 690 KPa (100 PSI)
Diameter (OD x L): 7.6 x 31 cm (3" x 12")
Operational depth with Aardvark unit: from 3 m (10 ft) to 15 m (50 ft)



THEORY OF OPERATION and DEFINITIONS

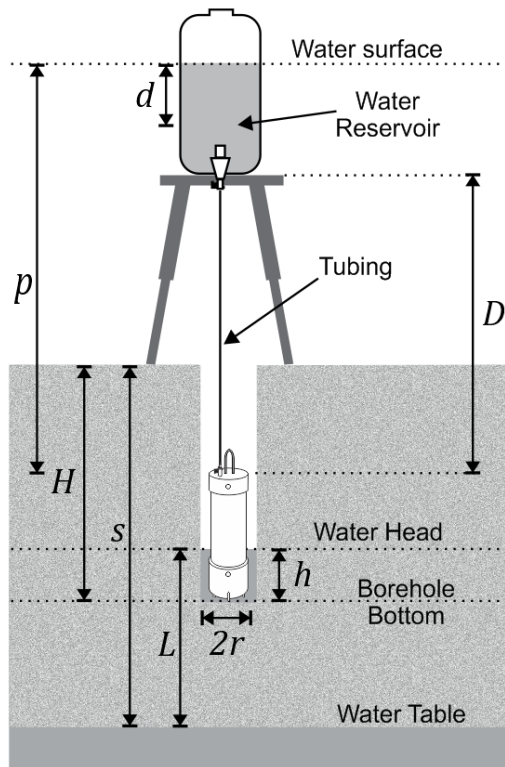

Fig. 6. Schematic of a Standard Setup of an Aardvark Permeameter. Where d is drop in reservoir water level, D is vertical distance between Reservoir and APM, H = borehole depth, r = borehole radius, h = constant water head height in borehole, p = vertical distance between water surface in reservoir and constant water head, s = water table depth and L = the vertical distance between constant water head and water table / impervious layer.

Saturated hydraulic conductivity (K_{sat}) is an indicator of water flow rate in soil and is a key parameter for studying water flow and chemical transport through a soil profile. These measurements can be vital to scientific and engineering studies. For example, it can be used in leach line placement in rural sewer systems and determine limits of rain/runoff conditions, and the ability of holding ponds to retain water.

The Aardvark is a constant-head permeameter. It means that the depth of water in borehole (h) does not change during the measurement period (Fig. 6). As a result, the measurement conditions remain constant during the measurement period. The rate of water supplied corresponds to soil infiltration rate from the bottom and side surfaces of the testing borehole.

The Aardvark Permeameter estimates soil hydraulic conductivity using the amount of supplied water (determined using d) measured at equal time intervals (Fig. 6). This is equivalent to the amount of water that was infiltrated by soil. Soil-water infiltration rate is the amount of percolated water over time which is equivalent to the reservoir flow rate (see equation below).

$$\text{reservoir flow rate} = \frac{\text{reservoir water change}}{\text{time}}$$

The measurement ends when the reservoir flow rate (soil-water infiltration rate) does not change over several consecutive readings. Soil hydraulic conductivity (K_{sat}) then can be calculated using this steady flow rate (Q). For more details see section "Calculations and Applications".

REQUIREMENTS PRIOR TO USE

Before making a measurement with the Aardvark Permeameter (APM) in the field, it is recommended to perform a site and soil evaluation, prepare a well hole, assemble the Permeameter, fill the Reservoirs, and place the Permeameter in the well hole. Upon arrival at the site, the user must evaluate the site with regard to topography, general soil appearance, intended application, and select the number and location of areas that are representative and intended for testing of the soils under study.

The suggested borehole diameter is about 10 cm (4"). Your APM will establish a stable water head height in the borehole. This standard combination is practical for almost all soils. For soils with very fine textures such as heavy clays a wider borehole can be used (not suggested) as well as higher head heights. Conversely, open textured soils such as coarser sands may do better with smaller borehole diameters.

The Aardvark Permeameter is designed to be installed in a borehole in soil profile from 20 cm (7.9") to 15 m (50 ft) depth. Therefore before installing the Aardvark Permeameter a borehole will need to be prepared. The equipment needed to dig a borehole depends on the width and depth desired. Our Model 0237D10L12 contains all the required tools and instructions to auger and clean a borehole with a 10 cm (4") width (recommended width for the Aardvark) down to a 4 m (12 ft) depth.

This set includes:

1. Loam Soils Auger
2. Auger Extension (30")
3. Well Prep Brush
4. Carrying bag
5. Sizing Auger
6. Auger Handle



Fig. 7. Model 0237D10L12 components.

If you are using the Model 2840K1, 2840K2, 2840K1PC, or 2840K2PC and want to record the readings manually, we have provided a data sheet in Appendix A for your convenience. We suggest a rugged pen or pencil for taking readings and notes. As part of your Aardvark Kit we have supplied a Countdown Timer to take readings on a scheduled basis. It is also advisable to have access to additional water in order to refill the reservoir in porous soils and for multiple tests. Please note that water used in permeameter tests should be clear and free of debris as it could have an effect on internal regulator functionality and on weight of water use calculations; therefore clean pure water is advised for all testing.

On windy days it may be difficult to read the water level in Reservoir. Wind also may have a negative effect on Digital Scale accuracy. In the case of severe wind the system can be set up inside a tent.

Operating Model 2840K1 and Model 2840K2

Aardvark Pressure Regulator Unit (RU)

In these instructions, we refer to “Shallow Measurements” for measurements with a D (Fig. 6) less than 3.44 m (11.3 ft) using only the Aardvark Permeameter Module (no RU in line). We also refer to “Deep Measurements” - measurements with a D more than 3.44 m (11.3 ft) using the RU and APM in line.

For Deep Measurements use the RU in line with the Aardvark Permeameter Module (Shallow Measurements do not require the use of an RU; the APM can be connected directly to the Reservoir). Install the RU above the APM (with minimum vertical distance). If you need to perform a Deep Measurement, follow these steps:

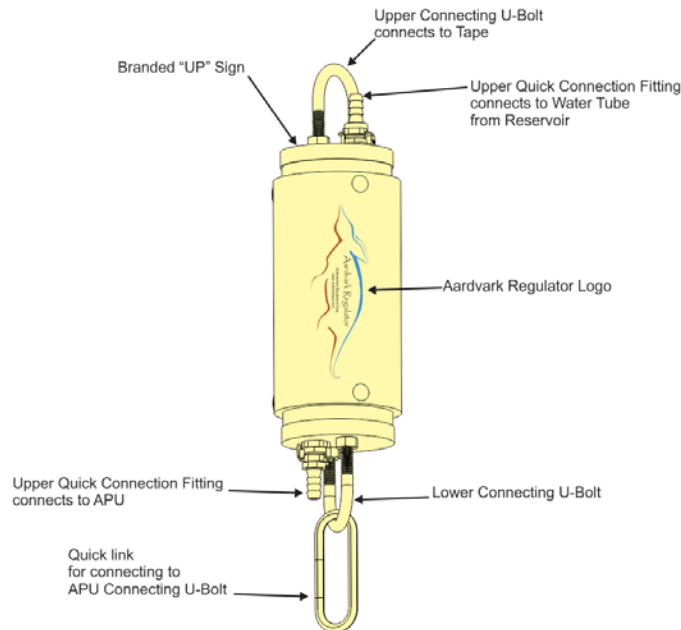

Fig. 8. Aardvark Regulator Unit

Determine input and output of the RU. The RU is completely symmetrical, so it is very important to install the RU right side up. (The Aardvark in the Logo should be “crawling out of the hole”). The RU input tube is towards the Aardvark head in logo (up). The input tube connects the RU to the Reservoir. The RU output tube is towards Aardvark’s tail in the logo (down). The RU output (Fig. 8) connects the RU to the APM. If, for any reason, the Aardvark Regulator logo cannot be clearly seen on the RU, there is a Branded “UP” sign on the top of the RU that can be used for proper orientation.

Connect the Quick Link to the RU’s Lower U-Bolt. The Quick Link provides an easy and secure connection between the two units.

Connect the RU output to the APM Quick Connection using the RU-APM connection tube.

Connect the RU input to the Reservoir using the Connection Tube.



Components of the Aardvark Permeameter Module (APM)

The Aardvark Permeameter Module is shipped completely assembled and ready to use (Fig. 9 left). The Aardvark Permeameter Module has three major parts: The Head Cap, The Body Tube and The Dispersive End Cap (Fig. 9, right).

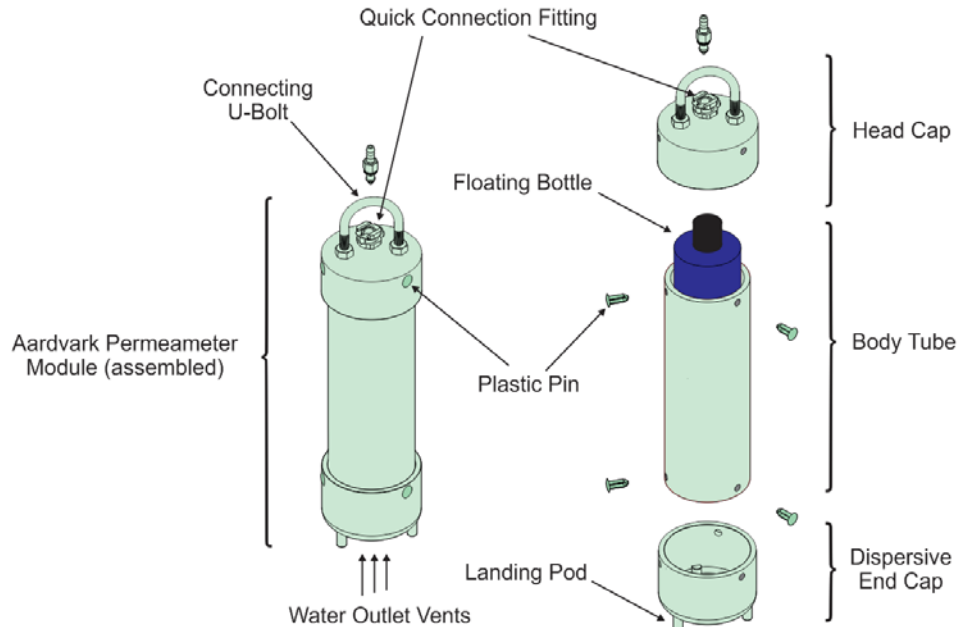

Fig. 9. Left: assembled Aardvark Permeameter Unit. Right: Major Components of APM.

On the top of the Head assembly there is a stainless metal U-Bolt (UB) for connecting to the Suspension Line (Measuring Tape) or Quick Link of the Pressure Regulator (Fig. 8). It is used for hanging and lowering the APM in a Borehole. The Quick Connection (QC) provides an easy and secure connection between the Head Assembly and Connecting Tubing (Fig. 9 right).

The Body Tube creates a head height about 9 to 10 cm deep (see section “*Installing APM in a Borehole*” for more details).

The Dispersive End Cap lands on the bottom of Borehole and serves as a base for the Permeameter and disperses the energy of out-flowing water from the vents and minimizes the risk of erosion of Borehole surfaces.

Assembling your Reservoir Unit:

Connect the Quick Connection provided in the Kit to the end of Tubing (Fig. 10a). The other end of Tubing connects to the APM or RU (if using an RU).

Connect the Valve to Reservoir and make sure the Valve is closed (Fig. 10b).

Connect the Quick Connection (Tubing) to Reservoir Valve (Fig. 10c).

Fill the Reservoir with clean water.

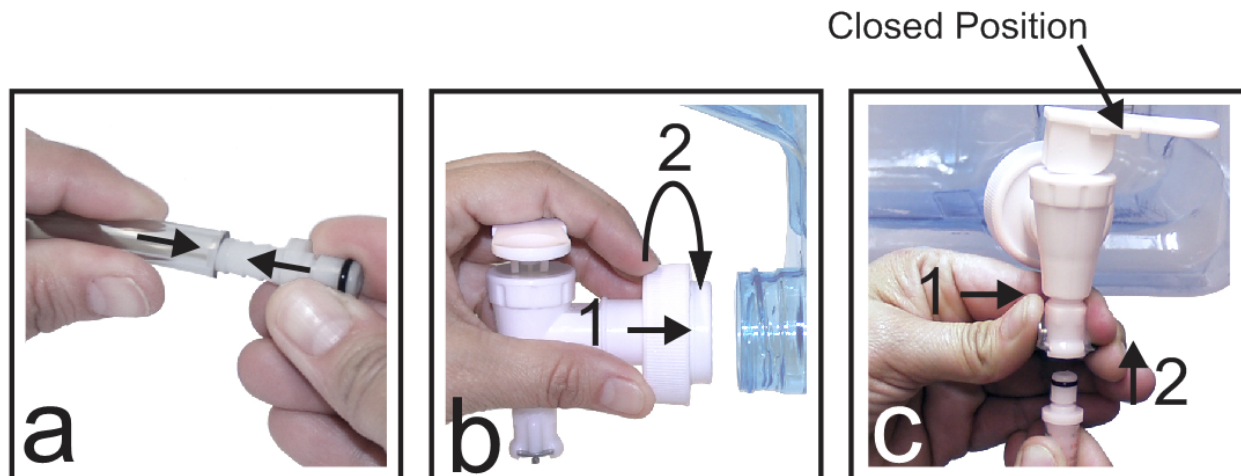

Fig. 10. Reservoir Assembly.

Assembling Aardvark Table

Slide open the Aardvark Table Cover (Fig. 11a).

Open each telescopic leg to the proper length and twist it until it is locked at the desire length (Fig. 11b). Use only 2/3 of the table height (56 cm) to add to its strength and stability. This height provides the proper amount of overhead pressure for shallow measurements.

Place the O-ring in the proper position. The small O-ring on the top of the leg may be a little off-set (Fig. 11c) and the leg may not be positioned correctly in the hole. Make sure the O-ring is in its proper place (Fig. 11d).

Put the top of each leg in its base under the table top (Fig. 11e) and turn it until it locks. Please note that the legs are not completely perpendicular with the table top.

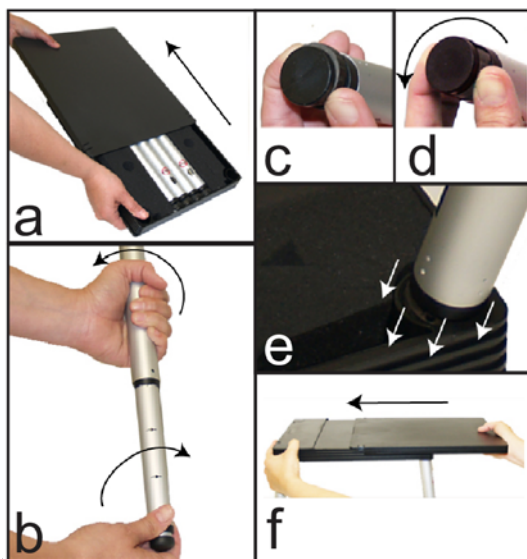

Slide the cover over the table top (Fig. 11e). It is important to place the Table on a sturdy surface so the legs do not penetrate into the soil and the Table is steady and level.

Table Placement

Place the Table next to the borehole. Try to position the Reservoir directly over the Borehole opening. This will eliminate excess water in the Connecting Tubing and allow for the most direct path between the Reservoir and the APM in the hole. Clear excess leaves, dried grass, and soil from the edge of the borehole and around the Table to prevent these materials from falling down the borehole during the test. Do not step on or across the well hole during the testing process.

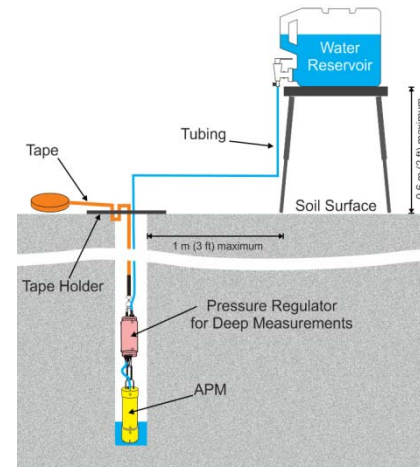

Connecting Tubing and Suspension Line

You may need to cut the Tubing according to the distance between the Reservoir and the APM (Fig. 12). Should you need to cut the Tubing, always cut a few feet longer than what you need. If you cut the Tubing too short, you can always reconnect the two pieces using a Tubing Coupler provided in the support kit.



Fig. 13. connecting two pieces of tubing using a Tubing Coupler.

Connect the QC fitting to the end of Tubing. Make sure that the fitting is fully inserted to prevent leaking (Fig. 14a). Do not use lubrication. This will increase the risk of leakage or the tubing may disconnect under pressure in Deep Measurements.

Connect the fitting to its base. Depending on the depth of your measurement, the Tubing from the Reservoir can either be connected directly to the APM (for Shallow Measurements) or to the RU (for Deep Measurements). Push in the small lever on the side of the base and connect the fitting (Fig. 14b). It is important to make sure that Tubing does not leak water.

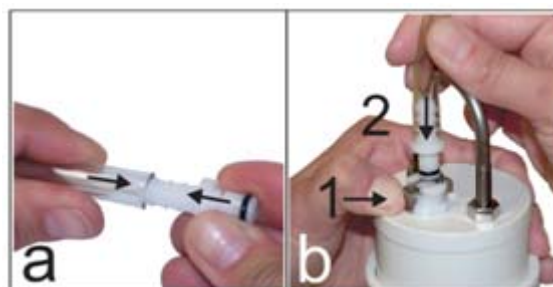

Fig. 14. Connecting the Quick Connection to the RU.

Connect the Tape Hook (Fig. 17). For Deep Measurements you will need to add the Pressure Regulator Unit in the line above the APM Unit (Fig. 16 right). Note that when the APM hangs from the Tape (with no Regulator Unit in the line), the numbers on the Tape show the distance to the very bottom of the APM. When the Regulator Unit is added in the line, it adds 30.5 cm (one foot) to the total length (Fig. 16 right). Please also note that one side of the Tape is in meters/centimeters and the other side in feet and tenths of a foot (not inches).



Fig. 15. Connecting Tape Hook to RU.

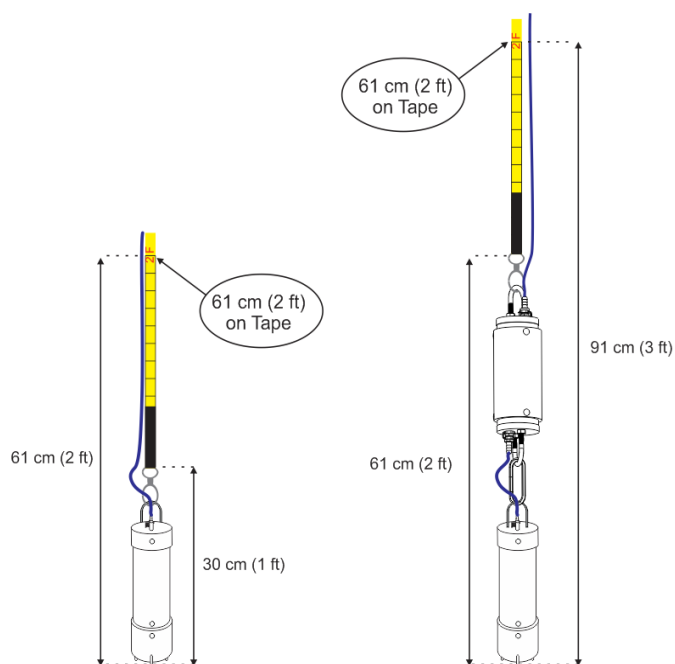

Fig. 16. Illustration of numbers on Tape. Left: APM without Regulator in the line (Shallow Measurements), right: APM with Regulator in the line (Deep Measurements).

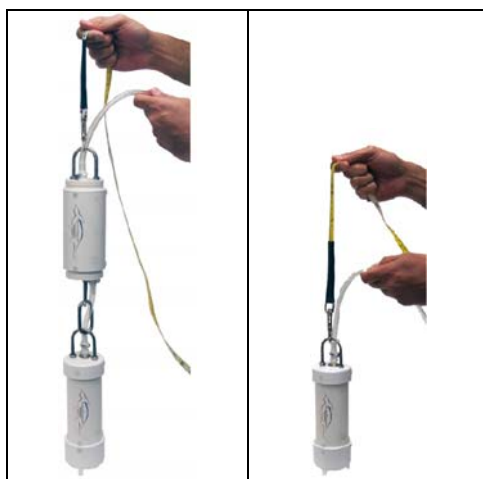

Fig. 17. Left: RU and APM are used for Deep Measurements. Right: for shallow measurements (less than 3 m or 11 ft depth) only APM is used.

Installing the APM in the Borehole

Standard Method:

After preparing the well and assembling the Table and Reservoir, connect the APM and Reservoir with their Tubing, and then lower the APM in the Borehole. The standard procedure is to make sure that APM is touching the bottom of the Borehole.



Fig. 18. Lowering RU and APM in borehole. Note do not hang from Tubing.

Carefully approach the Borehole Opening. Keep your feet away from the opening of the borehole as much as possible in order to prevent collapsing the upper parts of Borehole.

Using the Tape, carefully lower the APM into the Borehole until it reaches the bottom. It should touch the Borehole bottom and hang from the Tape at the same time (Tape is not slack). Note that if the APM is not in a vertical position, it may not work properly.

Secure the Tape using the Tape Holder when you feel the unit has touched the bottom of the borehole (Fig. 19).



Fig. 19. Tape secured using Tape Holder.

Secure the Tubing. Never let the Tubing hang directly from the Reservoir Valve. It may tip the Reservoir over in Deep Measurements. The Tubing is relatively heavy when filled with water. This is especially important when you are using the Digital Scale. Use the Tubing Clip provided in the Kit to secure the Tubing. See Fig. 5 for the proper way to secure the Tube with the Tubing Clip.

Secure the Borehole opening to prevent collapsing the upper parts of the well.

Record the depth of Borehole using Tape. When the APM is hanging in the Borehole, the numbers on Tape represent the distance from bottom of the APM (bottom of borehole). If the RU is in line, add another 30.5 cm (1 ft) to the Tape reading (Fig. 16).

Record the height of Reservoir (Table top) from soil surface. Use the Soilmoisture measuring tape provided in the Support Package.

Determine parameter D (Fig. 6). It is the vertical distance between the APM Floating Valve and Reservoir.

D (cm) = Depth of Borehole (cm) <plus> Height of Reservoir from Soil Surface (cm) <minus> 18.5 (cm)
D (inch) = Depth of Borehole (inch) <plus> Height of Reservoir from Soil Surface (inch) <minus> 7.25 (inch)

Determine the water head height. In Shallow Measurements ($D < 3$ m), the APM overhead pressure changes due to changes in D (Fig. 6). This is a small amount of change from about 9 to 10 cm, 3.5 to 3.9 inches. Knowing parameter D (previous step) it is possible to accurately calculate the height of water head (h):

h (cm) = 9.0 + 0.003D (cm)
h (inch) = 3.5 + 0.04D (ft)

The water level change in the Reservoir has a negligible effect on water head height (about 0.002 cm per each cm change in water level in the Reservoir). Therefore there is no need to adjust for the effect of water level change in the Reservoir in calculations.

For Deep Measurements (when $D \geq 3$ m (11 ft) and the RU is used), head height is always constant at 10.1 cm (4.0").

Raised Method Installation

In this method, the bottom of the APM does not land on the Borehole floor and it hangs from the Tape (never hang the APM from Tubing). In the Raised Method, the height of water head is determined by the length of the hanging part of Tape. This method may have some limited applications. For example, in soils with very low hydraulic conductivity raising the water head height will increase the borehole active surface area (the area that is in contact with water) and decrease the time needed for performing the measurement. It also increases the accuracy of measurements.

Although the Raised Method gives the user more flexibility in establishing different head heights, it is a little more complicated than the Standard Method.

Using the Raised Method in soils with high hydraulic conductivity can be problematic. The APM has been designed to create a small head height (about 10 cm).

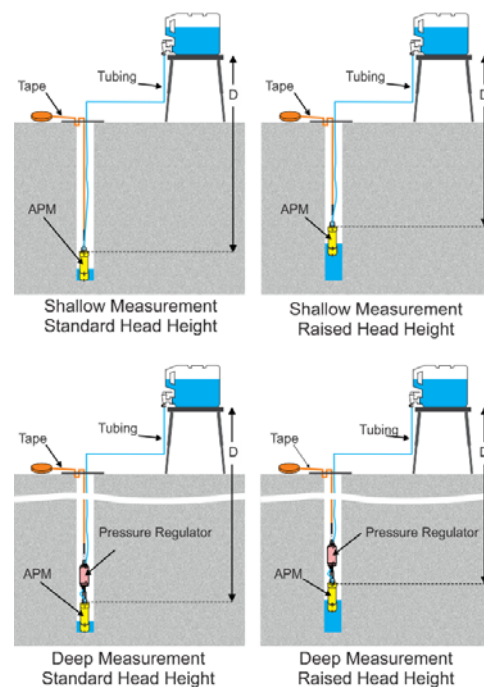

Fig. 20. Creating Standard (right figures) and Raised (left figures) head heights. Note that D is less than 3.44 m (11.3 ft) in Shallow Measurements while it is greater than 3.44 m (11.3 ft) in Deep Measurements.

Assuming the Borehole has the standard diameter of 10 cm (4"), the APM water supply would be sufficient to reach the water head in a short period of time. Using the Raised Method, the excess volume of the Borehole must be filled with Reservoir water and it takes more water and time to establish the water head height (in comparison with the Standard Method).

The Standard Method is more reliable since the water head depth is more accurate. In the Raised Method, there would be more Borehole erosion since water falls from the outlet vent in the borehole and, depending on the soil type and the distance of APM from the bottom of the hole, may cause significant erosion.

Carefully approach the Borehole Opening. In order to prevent collapsing the upper parts of the Borehole; try to keep clear from the Borehole opening as much as possible.

Using the Tape, carefully lower the APM into the Borehole until it reaches the bottom.

Secure the Tape using the Tape Holder (Fig. 19).

Secure the Tubing. Never let the Tubing directly hang from the Reservoir Valve. It may tip over the Reservoir in deep measurements. The Tubing is relatively heavy when filled with water. It is especially important when you are using Digital Scale. Use the Tubing Clip provided in the Kit. See Fig. 5 for the proper way to secure the Tube with the Tubing Clip.

Record the height of the Reservoir from the soil surface. Use the Soilmoisture Measuring Tape provided in the Support Package.

Record the depth of Borehole using the Tape. Remember that the numbers on the Tape represent the distance from the bottom of the APM (bottom of borehole). If the RU is in line, add another 30.5 cm (one ft) to the Tape reading (Fig. 16).

Raise the APM to the desired height considering that the water height would be equal to the raising height plus an additional height of about 9 to 10 cm (3.5 to 4.0"). Record the amount of the APM Raise for future reference.

Determine the depth of the APM. Remember that the number on the tape represents the distance to the bottom of the APM (if an RU is in the line, add another 30.5 cm (1 ft) to the number). Also note the distance between the bottom of the APM and its float valve is 18.5 cm (7.25"). Therefore the depth of the APM (actually the depth of its water valve) is equal to the number read on the tape at the borehole opening minus 18.5 cm (7.25"). If an RU is also in line, add another 30.5 cm (1 ft) to the number.

Calculate the parameter D (Fig. 6). It is the vertical distance between the APM unit and the Reservoir.

D (cm) = Depth of APM (cm) <plus> Height of Reservoir from Soil Surface (cm)

D (inch) = Depth of APM (inch) <plus> Height of Reservoir from Soil Surface (inch)

Determine the water head height. In a Shallow Measurement ($D < 3.44$ m, 11.3 ft), the water head height changes in small amounts (between about 9 to 10 cm or 3.5 to 4.0"). Knowing parameter D (previous step) it is possible to accurately calculate the height of water head (h):

h (cm) = 9.0 + 0.003D (cm) + APM Raise (cm)

h (inch) = 3.5 + 0.04D (ft) + APM Raise (inch)

For deep measurements (when $D \geq 3$ m (11 ft) and an RU is used), head height is always constant at 10.1 cm (4.0").

Note: Water level change in the reservoir has a negligible effect on water head height (about 0.007 cm per each cm change in water level in the Reservoir). Therefore we do not consider the effect of water level change in the Reservoir in our calculations.

Documentation Prior to Performing a Measurement

Appendix A is a sample datasheet that can be used for recording the measurements. For each sampling site, write the name and address (or lat/long) of the location, date, soil type and structure, borehole diameter, water head height, borehole depth, and water table depth. One can also record water temperature and sampling horizon description (optional). It is important to note that there are several standards and methods for calculating K_{sat} .

Making a Reading

Fill out the upper section of the data sheet provided in Appendix A (A sample data sheet is provided in Table 1).

Record the initial water level/volume in the Reservoir under column “Water Level in Reservoir” and the time under column “Time” in the first row of the table.

Open the Reservoir Valve. Depending on the Borehole’s dimensions and soil permeability, it may take from less than one minute to several minutes before establishing a constant water head. Boreholes wider than 10 cm (4”) would need considerably more time to establish a constant water head. Also water heads higher than the standard height need more time. In Shallow Measurements, since the overhead pressure from the Reservoir is low, it will take more time to achieve a constant water head.

Record the level of Reservoir water and time after appropriate interval. Use the Countdown Timer provided in the Support Kit. The time interval between recordings depends on the diameter of the Borehole, soil type and texture.

In soils with coarse textures the infiltration rate is higher and therefore smaller intervals are more suitable (between 1 to 5 min). Depending on method of calculation and considering that each increment on the Reservoir body is translated to 100 ml of water, for measuring a K_{sat} as low as 10^{-7} to 10^{-8} , a 60-minute sampling interval would be needed (assuming that the Borehole dimensions are standard). Also a deeper borehole or a larger Borehole diameter increases the total infiltration rate (Q) of the well and a smaller time interval can be used.

Note: If you are using a 2840K#PC or 2840K#RIF, the accuracy of your readings would be 500 times more (0.2 ml vs. 100 ml accuracy). Therefore for a K_{sat} as low as 10^{-7} to 10^{-8} , a 1- to 5-minute sampling interval would be enough.

It is not critical to record reading “sat exactly equal time” intervals but it is important to accurately record the time for each reading. It is possible to start recording several minutes after opening the Valve and when it seems that a constant water head has been well established and the soil around the Borehole is saturated. For each reading (data point) write the current time under column “Time” and write the level of water in the Reservoir under column “Reservoir Water Level”.

Add more water if Reservoir is low. Record the reservoir water level as well as time right before and after refilling. It is recommended not to let the Reservoir run out of water.

Determine the Steady Water Consumption Rate. The measurement ends when the “Water Consumption Rate” does not change over several consecutive readings. For each reading, Water Consumption Rate is calculated using the following formula:

$$R_i = \frac{d_{(i-1)} - d_i}{t}$$

Where R_i is Water consumption Rate of the current reading (ml/min), $D_{(i-1)}$ is Reservoir Water Level of the previous reading (ml), d_i is Reservoir Water Level of the current reading (ml), and t is the time interval between the previous reading and the current reading (min).



If you are using the SimplyDATA Software Suite application, there is no need to manually perform this calculation. If you are recording data manually, use Appendix A. You would need to calculate R_i for each reading until it reaches a steady state (the amount of R_i does not change significantly over several readings).

In the Steady Water Consumption Rate stage (Fig. 21), the steady “Water Consumption Rate” is equivalent to the soil Steady Flow Rate (Q) or Soil-Water Steady Infiltration Rate which is the key parameter to calculate saturated hydraulic conductivity.

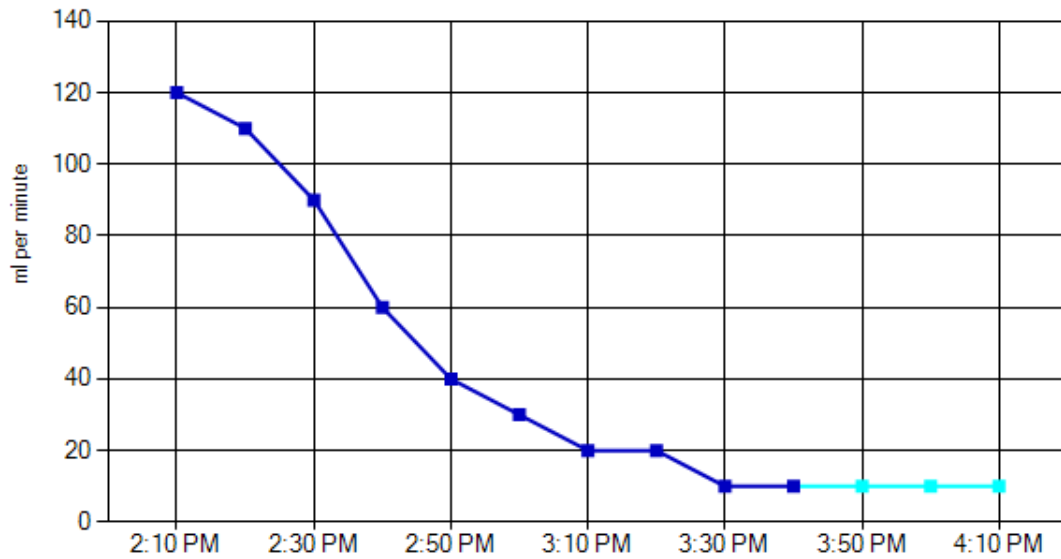

Fig. 21. Water Consumption Rate against time. The cyan points represent steady flow rate (Q).

Operating Model 2840K1PC and Model 2840K2PC

(Automated Readings Using a PC)

Performing measurements are much more accurate and easy using the PC Kits. These kits contain a 2840K1 kit (for Shallow Measurements) or a 2840K2 kit (for Deep Measurements) as well as a Digital Scale (Model 7201W10). See kit components in Fig. 2 and Fig. 3.

The Digital Scale is connected to a personal computer or laptop (not included) using a USB port and records the measurements automatically. The accuracy of measurements for water flow rate is 0.2 gram (one gram is equivalent to one ml (cc or cm³) of volume for pure water). Once the steady flow rate is established in the Borehole, the software calculates K_{sat} automatically and there is no need to continue the measurements (although it is possible). This kit is ideal for automated and accurate measurements in the laboratory and outdoors (when a personal computer is available).

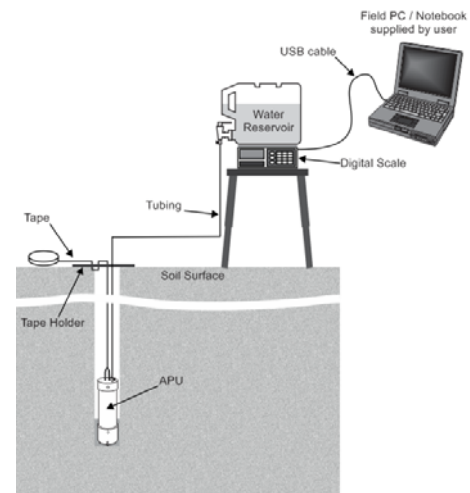

Fig. 22. Schematic of Model 2840K1PC setup and arrangement.

In case a PC is not available, the 2840K1PC and 2840K2PC can still be used as a more accurate version of the Basic Aardvark. The SimplyDATA Scale operates on batteries. Therefore it can be used wherever needed.

The Installation procedure is similar to Model 2840K1. Refer to the section “Operating Model 2840K1 and Model 2840K2” for instructions about assembling and placement of the Aardvark Table; components; assembling and installing the Aardvark Permeameter Module (APM) in a Borehole and assembling the Aardvark Reservoir Unit (RU).

After preparing a Borehole and Installing the APM, follow these steps:

Place Scale and Reservoir on the Table and make sure that they are centered with the Table legs (Fig. 23). Note that the Reservoir is relatively heavy and if it is not centered with Table legs, it may tip over.

Connect the Scale to your PC using the USB cable provided in the kit. Please refer to the USB Digital Scale (Model 7201) operating Instructions for more details and illustrations.

Install the SimplyDATA Software Suite on your computer (if not already installed). Please refer to the SimplyDATA Software Suite (Model 8010SFAGB02) Operating Instructions for more details.

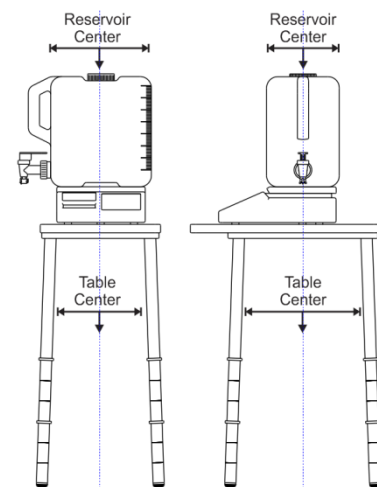
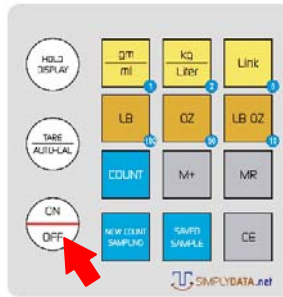
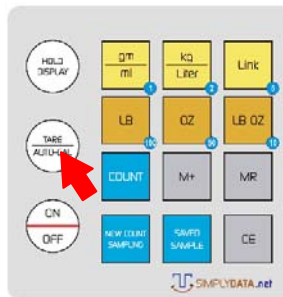

Fig. 23. How to center Scale and Reservoir with Table.

Turn on the Scale.



Tare the Scale if needed. It is not really important for the software to tare the scale. However it ensures more readable data (especially if making readings manually).



Connect the Valve Quick Connection provided in the kit to the end of the Tubing (Fig. 14 a). The other end of the Tubing should be already connected to the RU or APM.

Connect the Valve to the Reservoir and make sure the spigot is closed (Fig. 10).

Fill Reservoir with clean water up to 7 liters (2 gallons) and replace the Cap. Dry the Reservoir exterior if needed. Note that the Scale is an electronic device and for better performance it needs to be kept dry and clean.

Carefully place the Reservoir on the Scale and make sure that both the Reservoir and Scale are level and centered with the four legs of the Table.

Connect the Tubing to the Reservoir Valve and secure the Tubing to the Table using the Tubing Clip provided (see Fig. 3 left, for a suggested Clip position). NOTE: the Tubing should not hang from the Reservoir otherwise moving the tubing would affect the Scale readings. Also try not to shake the Reservoir. It can affect the Scale readings. Wind can have a dramatic effect on Scale performance. Protect the Table setup from wind if necessary. In the case of severe wind, it is recommended to set the table up in a tent.

Remove the Reservoir Cap.

Making a Reading

If you are recording readings manually, please refer to the section “Making a Reading” in the 2840K1 instructions. Please note that the precision of the Scale is relatively high (0.2 ml). In comparison with the increments on the Reservoir, it is 500 times more accurate; therefore you can reduce the reading interval time dramatically. Using a Borehole with standard dimensions (10 cm diameter and about 10 cm water head) and with a one minute reading interval you are able to measure K_{sat} values as small as 10^{-7} to 10^{-8} m/s. In the case that the Scale is connected to a PC, you would be able to make readings automatically. Please refer to the SimplyDATA Software Suite (Model 8010SFAGB02) Operating Instructions for more details.



Operating Model 2840K1RIF and Model 2840K2RIF

(Self-Sufficient Automated Measurements)

This kit is a self-sufficient automatic system. Record It in a Flash (RIF) is designed to eliminate the need for a computer in outdoor automated samplings and where a computer is not available. The kit contains a 2840K1 kit (for Shallow Measurements) or a 2840K2 (for Deep Measurements), a Digital Scale (Model 7201W10) and an RIF (Model 7205). Fig. 3, Fig. 4 and Fig. 5 show the system components.

Record It in a Flash is connected to the Scale and stores the measurements. Once a Steady Flow Rate is established, the RIF automatically calculates K_{sat} and alerts the user to end the experiment (if desired). This feature makes it extremely easy to operate Aardvark Permeameter even by inexperienced users.

Record It in a Flash also supplies power to the Scale. This way there is no need to connect the Scale to a personal computer or power source. The RIF uses 4 C-size alkaline batteries. It is able to operate for hours when no other source of power is available. The RIF also has an AC-DC Wall Adapter for indoor applications.

The Installation procedure is very similar to Models 2840K#PC. Refer to the "Operating Model 2840K1..." section for instructions about assembling and placement of the Aardvark Table; installing the Aardvark Permeameter (just APM or APM plus RU) in a Borehole and setting up the Aardvark Reservoir. See Figure 24 for arrangement of the Reservoir, Scale and RIF on the Table. Level the Scale and Reservoir and center them with the four legs of Aardvark Table (Figure 25). Connect the Scale to the RIF (using the USB cord provided in the Scale Case) and follow the RIF's instructions (7205 Operating Instructions that comes with RIF) for initializing and operation. For transferring data from the RIF to your PC refer to the Model 8010SFAGB02 (SimplyDATA Software Suite) application manual.

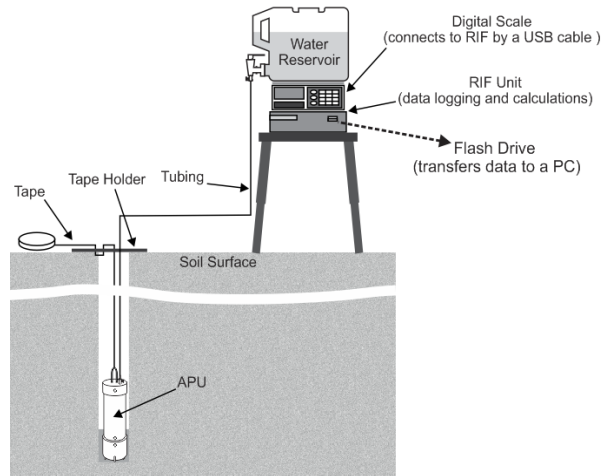

Figure 24. Schematic of Model 2840K1PC arrangement.

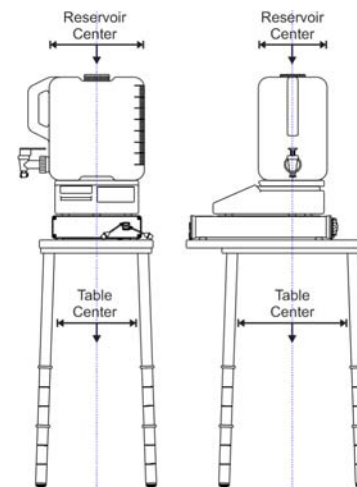

Figure 25. How to center RIF, Scale and Reservoir with Table.

Making a Reading

Using the 2840K#RIF you are able to make readings automatically. Please refer to Record It in a Flash (Model 7206) Operating Instructions for more details.

USEFUL HINTS DURING NORMAL USE

Familiarize yourself with the setup, operation, procedure theory, and calculations before going to the field with the Aardvark Permeameter. Doing so will facilitate accurate measurements and interpretation of results.

If you collapse the Borehole, the RU and APM could fall in. The Suspension Line (Tape) is robust and durable; however you should protect it with a rope or cable line. This would be a great help when you are trying to remove the APM from a collapsed borehole.

Wash the APM after each measurement. It will protect it against leaking and guarantee a long and reliable performance.

Always keep an eye on connections. Leaks in connections can dramatically reduce the measurement accuracy. Aardvark connections are robust and reliable; however, putting stress on connections (e.g. hanging the APM from tubing or using lubrication to connect two pieces of tubing) can make them susceptible to leaks especially in deep measurements when the overhead pressure is high.

Never let the Tubing hang directly from the Reservoir Valve. When the Tubing is filled with water, its weight can tip over the Reservoir and if it doesn't, it definitely would have a negative impact on Scale readings. Secure the Tubing in the way that its weight is not on the Reservoir Valve. Also use Tubing Clip to secure Tubing on Table.



TROUBLESHOOTING

Problem

Possible Reason

The Scale "Self-test" procedure takes a long time

The scale is shaking due to wind or other reasons. Protect Scale and the Table setup from wind. The ultimate solution to the wind problem is to set up the Table in a secured tent.

The numbers on Scale jump up and down

This usually happens due to wind. Try to protect the Table setup from wind.

From the beginning of the measurement, Water Consumption Rate does not reduce over time.

It may have two specific reasons.
First: soil is too fast (excessive hydraulic conductivity, for example coarse sand or gravel). In this case Aardvark water supply rate is less than soil infiltration rate and a constant heat cannot be established.
Second: the Floating Valve is not working properly. Remove the APM Cap and check it.

Reservoir body collapses gradually over time

The Reservoir Cap is on. Take the Reservoir Cap off to let water flow freely to the Borehole.



GENERAL CARE AND MAINTENANCE

Disassembling the Aardvark Permeameter Module

You may want to take the APM apart to clean it. Remove the Connecting Pins from the APM and separate it from the Body Tube. The Pins are designed so you can push them in or take them out easily without any tools. However there is a Pin Access Tool in the Support Kit should you need it. To avoid injury, please take special care while working with the Pin Access Tool. Avoid removing a Pin using a screwdriver or other sharp tools.

Cleaning APM

1. Use the Pin Access Tool to remove Pins from the upper part of Body Tube. Detach Head Assembly from Body Tube. There is no need to detach the End Cap from the Body Tube.
2. Soak the components in soapy water for 5 minutes and then rinse with clean water.
3. In order to clean the internal parts of the Head Assembly and Floating Valve, pour soapy water into the Reservoir. Then connect the Reservoir to the Head assembly using the Tubing and open the Valve and let the soapy water run through Head Assembly. Repeat this procedure with clean water allowing it to flow through the Head Assembly for one or two minutes. This will assure a long and reliable performance of the unit.
4. Put Floating Bottle inside Body Tube and make sure that it can move up and down freely.
5. Connect Head Cap to Body using Pins.



USE AND APPLICATION OF PRODUCT OPTIONS

Borehole Preparation Kit

The Aardvark permeameter is designed to be installed in a borehole in a soil profile from 20 cm (7.9") to 15 m (50 ft) depth. Therefore before installing Aardvark Permeameter, you need to dig and prepare a borehole. The equipment needed to dig a borehole depends on the width and depth of the desired hole. Our Model 0237D10L12 contains all the required tools and instructions for augering and cleaning a borehole with 10 cm (4") width (Aardvark recommended width) and up to 4 m (12 ft) depth.

Aardvark Pressure Regulator Unit (RU)

The APM has been designed to perform under a maximum of 5 psi (about 344 kPa or 3.44 m of water column). Therefore for Deeper Measurements ($D \geq 3.44$ m), you need to use an Aardvark Pressure Regulator in-line. The RU reduces the overhead pressure to 344 kPa (5 psi). Simply add the RU in line with the APM so that water goes through the RU before the APM. Note that the vertical distance of the RU and APM must be minimal. An RU Connection Tubing and a Quick Link comes with the RU to connect the RU and APM (Fig. 27).

In Shallow Measurements you do not need the Regulator Unit (RU).

The Aardvark Permeameter can be used anywhere a hole can be augered in soil. Because of the practical improvements incorporated in the operation of the Aardvark Permeameter and the advanced analysis the theory provides, it is ideally suited for applications involving the design and monitoring of:

- Irrigation Systems
- Drainage Systems
- Canals
- Reservoirs
- Sanitary Landfills
- Land Treatment Facilities
- Tailings Areas
- Hazardous Waste Storage Sites
- Septic Tank systems
- Soil and Hydrologic Studies and Surveys



Fig. 26. Model 0237D10L12 Borehole Preparation kit.

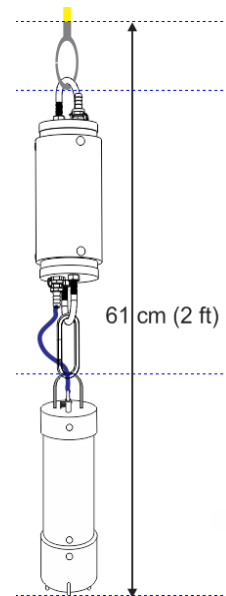

Fig. 27. Regulator Unit in line with APM.

CALCULATIONS AND APPLICATIONS

Using the SimplyDATA Software Suite for manually recorded data

The Aardvark Permeameter kit contains a flash drive with the SimplyDATA Software Suite. The software performs all the necessary calculations required for calculating soil hydraulic conductivity. To use the software you will need a personal computer. Simply enter the raw measurements data and it calculates K_{sat} as well as some other useful parameters and graphs. Please refer to the “SimplyDATA Software Suite Operating Instructions” for more details. If you are using the Model 2840K#PC connected to a computer or Model 2840K#RIF, the software performs all the measurements and calculations automatically. Please refer to the SimplyDATA Software Suite Operating Instructions for more details.

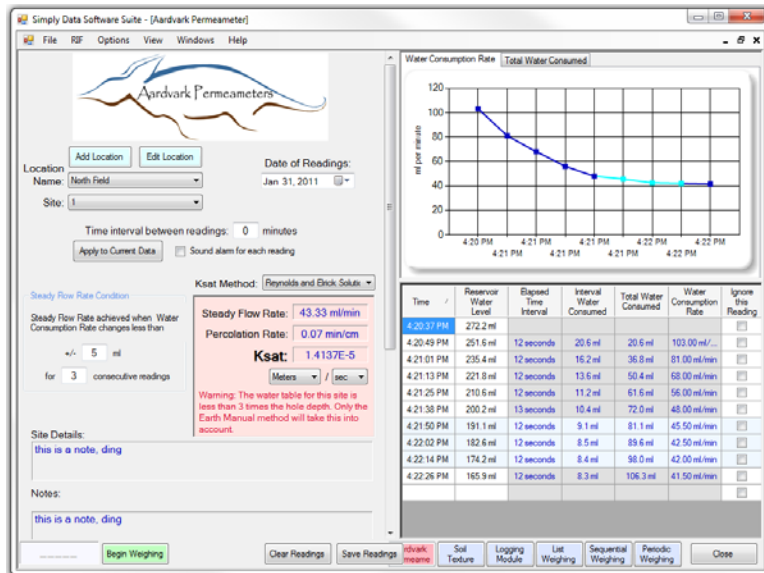

Fig. 28. Permeameter application of the SimplyDATA Software Suite.

Manually Performing the Calculations

These instructions use the method introduced by US Department of Interior (Earth Manual Part2, Third Edition, and P. 1234-5. Denver, Colorado 1990). The SimplyDATA Software Suite is able to calculate K_{sat} using three different methods.

Determining the Steady Flow Rate (Q)

A sample data sheet is presented in Table 1. For determining Steady Flow Rate, follow the below instructions.

Calculate “Elapsed Time Interval” for each reading in minutes. It is the difference of “Time” of the reading with “Time” of the previous reading (see the bold calculations in each cell of table). Therefore for the first row of the table (the first reading), “Elapsed Time Interval” is not calculated.

Calculate “Interval Water Consumed” for each reading in milliliter (ml). It is the amount of water that goes to Borehole during the two consecutive intervals. In other words, it is the difference between “Reservoir Water Level” of a reading and “Reservoir Water Level” of the previous reading (see the bold calculations in each cell). Therefore for the first line of the table (the first reading), “Reservoir Water Level” is not calculated. Note the volume of one gram of water is one ml (cc or cm^3). Therefore generally speaking, for pure water, the three units are equivalent and one can use any of them for the other one.

Calculate “Total Water Consumption” as the total sum of “Water Consumption Rate” (see the bold calculations). Calculating of this column is optional.

Calculate “Water Consumption Rate” for each reading in ml/s. For each line of Table 1, “Water Consumption Rate” can be calculated by dividing “Interval Water Consumed” by “Elapsed Time Interval” (see the bold calculations). Therefore for the first line of the table (the first reading), “Water Consumption Rate” is not calculated.

Determine the Steady Flow Rate (Q). It is established when “Water Consumption Rate” (flow rate) does not change significantly over several consecutive readings. Obviously “Water Consumption Rate” would not be exactly equal between consecutive readings even when a steady flow has been established. Using the Water Consumption Rate graph against time is a useful tool for determining Q. In this graph, the horizontal phase of curve (parallel with time axis) represents the amount of Q. In Table 1, since “Water Consumption Rate” does not change from Reading 10 to Reading 14, we assume that the Steady Flow Rate (Q) is 10 ml/min. Fig. 29 is the graphical presentation of the same data. For converting Q unit from ml/min to gallon/s, it has to be multiplied by 0.000264.

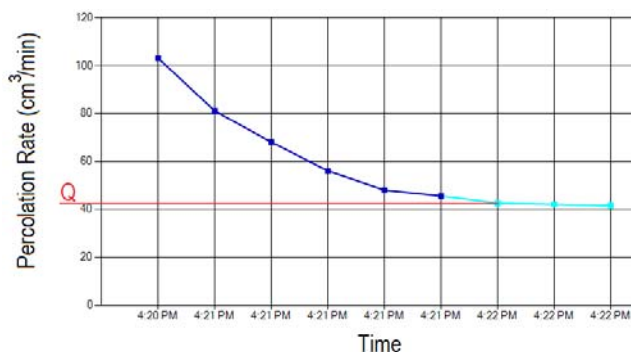

Fig. 29. Soil-water infiltration rate over time and Steady Flow Rate (Q).

Table 1. A sample data sheet. The bold writings are for illustrating the calculations. Columns "Time" and "Water Level in Reservoir" are the readings from Aardvark Permeameter. Other columns have to be calculated.

Aardvark Permeameter Field Data Sheet				READING AND CALCULATION		
DATE:		INVESTIGATOR:		Q: Steady Flow Rate (ml/min): 10		
2r: Borehole Diameter (cm): 10.16		h: Water Height in Borehole (cm): 10.1		S: Depth of Water Table (cm): 350		
H: Borehole Depth (cm): 340		D: Vertical distance between Reservoir and APM (cm): 400		Water Temperature: 20		
Soil Texture/Structure Category: structured agri. soil						
Reading Number	Time	Water Level in Reservoir (ml)	Elapsed Time Interval (min)	Interval Water Consumption (ml)	Total Water Consumption (ml)	Water Consumption Rate (ml/min)
1	2:00 pm	7000				
2	2:10 pm	5800	2:10 - 2:00= 10	7000 - 5800= 1200	1200	1200 / 10= 120
3	2:20 pm	4700	2:20 - 2:10= 10	5800 - 4700= 1100	1200 + 1100= 2300	110 / 10= 110
4	2:30 pm	3800	2:30 - 2:20= 10	4700 - 3800= 900	2300 + 900= 3200	900 / 10= 90
5	2:40 pm	3200	2:40 - 2:30= 10	3800 - 3200= 600	3200 + 600= 3800	600 / 10= 60
6	2:50 pm	2800	2:50 - 2:40= 10	3200 - 2800= 400	3800 + 400= 4200	400 / 10= 40
7	3:00 pm	2500	3:00 - 2:50= 10	2800 - 2500= 300	4200 + 300= 4500	300 / 10= 30
8	3:10 pm	2300	3:10 - 3:00= 10	2500 - 2300= 200	4500 + 200= 4700	200 / 10= 20
9	3:20 pm	2100	3:20 - 3:10= 10	2300 - 2100= 200	4700 + 200= 4900	200 / 10= 20
10	3:30 pm	2000	3:30 - 3:20= 10	2100 - 2000= 100	4900 + 100= 5000	100 / 10= 10
11	3:40 pm	1900	3:40 - 3:30= 10	2000 - 1900= 100	5000 + 100= 5100	100 / 10= 10
12	3:50 pm	1800	3:50 - 3:40= 10	1900 - 1800= 100	5100 + 100= 5200	100 / 10= 10
13	4:00 pm	1700	4:00 - 3:50= 10	1800 - 1700= 100	5200 + 100= 5300	100 / 10= 10
14	4:10 pm	1600	4:10 - 4:00= 10	1700 - 1600= 100	5300 + 100= 5400	100 / 10= 10



Calculating saturated hydraulic conductivity (K_{sat})

Saturated Hydraulic conductivity can be calculated using several methods. The following calculations are based on USBR 7300-89 procedure (Earth Manual Part2, Third Edition, and P. 1234-5. Denver, Colorado 1990). SimplyData Software Suite is able to perform some other methods (please refer to SimplyData Software Suite Operating Instruction).

Depending on the value of L/h ratio (L is the vertical distance between constant water head (h) and water table / impervious layer; see Fig. 6), K_{sat} can be calculated from different formulas:

Condition I: when L/h is greater than three ($L/h > 3$)

$$K_{sat} = \frac{Q}{2\pi h^2} \left\{ \ln \left[\frac{h}{r} + \sqrt{\left(\frac{h}{r}\right)^2 + 1} \right] - \frac{\sqrt{1 + \left(\frac{h}{r}\right)^2}}{\frac{h}{r}} + \frac{1}{\frac{h}{r}} \right\} \quad \text{Unit: cm/min} \quad \text{Equation [1]}$$

Condition II: when L/h is between one and three ($1 \leq L/h \leq 3$)

$$K_{sat} = \frac{Q}{2\pi h^2} \left[\frac{\ln(h/r)}{\frac{1}{6} + \frac{1}{3} \left(\frac{L}{h}\right)} \right] \quad \text{Unit: cm/min} \quad \text{Equation [2]}$$

Condition III: when L/h is greater than three ($L/h < 1$)

$$K_{sat} = \frac{Q}{2\pi h^2} \left[\frac{\ln(h/r)}{\frac{L}{h} + \frac{1}{2} \left(\frac{L}{h}\right)^2} \right] \quad \text{Unit: cm/min} \quad \text{Equation [3]}$$

Where K_{sat} is saturated hydraulic conductivity (cm/s), Q is steady flow rate (ml/s), h is height of constant water head in Borehole (cm), r is radius of Borehole (cm) and L is the vertical distance between water surface in Borehole and the water table (cm), \ln is the symbol for natural logarithm and π is 3.14. Note: for converting K_{sat} unit from cm/s to inch/s, it has to be multiplied by 0.39.

Parameter L can be easily calculated:

$$L = s - H + h = 350 - 340 + 10.1 = 20.1 \quad \text{Unit: cm} \quad \text{Equation [4]}$$

Where H is borehole depth, h is constant water head height in borehole, s is water table depth and L is the vertical distance between constant water head and water table/impervious layer.

Since the L/h ratio in Table 1 is between 1 and 3, Equation [2] has to be used for calculating K_{sat} :

$$K_{sat} = \frac{10}{2\pi 10.1^2} \left[\frac{\ln(10.1/5.08)}{\frac{1}{6} + \frac{1}{3} \left(\frac{20.1}{10.1}\right)} \right] = 0.0010 \quad \text{Unit: cm/min} \quad \text{Equation [5]}$$

REPLACEMENT PARTS LIST

REPLACEMENT PARTS

ITEM	PART #	DESCRIPTION
Aardvark Carrying Case	XCASE-PLBD25X14X7	
Tape Holder	2840K1-0000-03	
Aardvark Permeameter Module	2840-1000	
Aardvark Reservoir	2841V2.0	
Countdown Timer	XLB-TIMER60MMECH	
Measuring Tape/ Suspension Line	2844L50	50 feet
Connecting Tube	XTPTY-0.250X0.375	50 feet
Aardvark Pressure Regulator Unit	2840-2000	For measurements deeper than 3 m (10 ft)
Aardvark Table	XUTABW14XH11	
Aardvark Operating Instructions	0898-2840	
Aardvark Support Package	2840K1SUPKG	
SEC All Weather Notebook	0899-006	
Plastic Connection Pin	XFPNY.250AC9	
Tubing Coupler (Barbed Connector)	XPB44T-4BTX4BTTP	¼" to ¼"
Quick Connection Insert	XPBQC-4BTMPCAT	¼" hose to PMC
Pin Access Tool	XTLH-4" TACKPULLER	
Hose Clamp	XHWCHC-5/16-13/32	5/16" to 13/16" to 13/32" Zinc Plated Steel
LED Flash Light	XHWMIS-LEDFLASH	
Tubing Clip	XHWCL-#4CLIP	
SILICON Grease	MFJ012PK	¼ Once
SEC Writing Pen	0899-009	
SEC Tape Measure		6 ft.
Flash Drive Loaded with SimplyData Software Suite	8010SFAGB02	
Digital Scale Package	7201W10PKG	Complete package in the case
Digital Scale	7201W10-001	The unit itself (10 Kg, 0.2g accuracy)
Scale Carrying Case	7202	
USB Cable	XCMPC-UFUML05	For Digital Scale
Scale Power Supply	7201PWR	
Record It in a Flash (RIF)	7205RIF	The unit itself
RIF Carrying Case	7206	
'C' Size Alkaline Battery	XBATAKR-C1.5V	1.5 V
RIF Power Supply	7205PWR	

ACCESSORIES AND USEFUL ITEMS FOR THIS UNIT

ITEM	PART #	DESCRIPTION
Borehole Preparation Kit	0237D10L10	
Loam Soils Auger	0234LOMBD10	10 cm Loam Soil Auger, Dutch Type, bayonet connection
Auger Extension Rod	0234SHDLBXL30	30 cm Auger Extension Rod, bayonet connection
Well Prep Brush	0234WPBBD10	10 cm Well Prep Brush, bayonet connection
Carrying bag	XBAG-0237	Auger Kit Carrying Bag
Sizing Auger	0234HBPBD10	Sizing Auger, 10cm hole, bottom prep, bayonet connection
Auger Handle	0234SHDLB	Auger Handle with detachable grip, 60 cm, bayonet connection



Appendix A

Aardvark Permeameter Sample Datasheet

Aardvark Permeameter Field Data Sheet				READING AND CALCULATION		
DATE:		INVESTIGATOR:		Q: Steady Flow Rate (ml/min):		
2r: Borehole Diameter (cm):				h: Water Height in Borehole (cm):		
H: Borehole Depth (cm):				S: Depth of Water Table (cm):		
D: Vertical distance between Reservoir and APM (cm):				Water Temperature:		
Soil Texture/Structure Category:						
Reading Number	Time	Water Level in Reservoir (ml)	Elapsed Time Interval (min)	Interval Water Consumption (ml)	Total Water Consumption (ml)	Water Consumption Rate (ml/min)



**With dealers throughout the world,
you have convenience of purchase and assurance
for after sales service.**

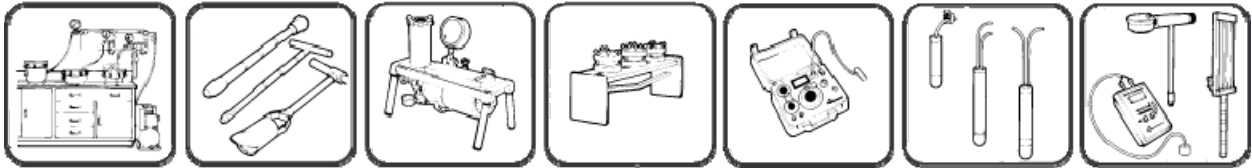

Low-Flow Groundwater Sampling for Chemical Analysis

April 22, 2014

ENVIRON International Corporation

TABLE OF CONTENTS

1. Purpose and Scope.....3

2. General Requirements.....3

3. Methods.....4

4. Equipment and Materials.....4

5. Procedures.....5

 5.1 Pre-Sampling Activities.....5

 5.2 Purging and Sampling.....6

 5.3 Equipment Decontamination.....8

6. Quality Control Samples.....9

7. Sample Handling and Custody.....10

 7.1 Sample Identification.....10

 7.2 Sample Labels.....10

 7.3 Containers, Preservation, and Hold Time.....11

 7.4 Sample Handling and Transport.....11

 7.5 Sample Chain-of-Custody.....12

8. Field Documentation.....13

9. References.....14

1 Purpose and Scope

This standard operating procedure (SOP) describes the procedures to be followed by a Field Geologist/Engineer while collecting groundwater samples using low-flow purging and sampling procedures. The low-flow methodology may alternatively be referred to by names such as “micropurging”, “low-stress purging”, low-impact purging, or “minimal drawdown purging.” This SOP should be used primarily for collection of groundwater samples from permanent wells that have been designed, constructed, and developed for the purpose of monitoring groundwater. The groundwater samples that are collected using this SOP are acceptable for the analysis of environmental contaminants including, but not limited to: volatile organic compounds (VOCs), semi-volatile organic compounds (SVOCs), pesticides and herbicides, polychlorinated biphenyls (PCBs), petroleum hydrocarbons, metals, and other inorganic compounds.

The procedures presented herein are intended to be of general use and may be supplemented by a Work Plan, Sampling and Analysis Plan, Quality Assurance Project Plan, and/or a Health and Safety Plan. Some of these procedures may not be required depending on the specific scope of work being conducted. As the work progresses, and if warranted, appropriate revisions may be made by the Project Manager. Procedures in this protocol may be superseded by applicable regulatory requirements.

2 General Requirements

All personnel performing on-site operations with the potential for exposure to hazardous substances or health hazards are required to be 40-hour trained in accordance with Code of Federal Regulations (CFR) 1910.120 and will meet the personnel training requirements in accordance with 29 CFR 1910.120(e).

The laboratory must be certified by the appropriate regulating agency for the analyses to be performed. If drilling is required as part of the scope of work, permits will be acquired from the appropriate agency, and an underground utility check will be performed before drilling begins. An underground utility check will, at a minimum, consist of contracting with a local utility alert service, if available. Under certain circumstances, including at sites with deeply buried, unknown, or multiple underground utilities, as well as at high risk sites such as oil refineries and heavy industrial facilities, manual utility clearance using hand auger or air knife methods should also be performed.

The activities described in this SOP require the implementation of a site-specific Health and Safety Plan to inform personnel of the hazards associated with this work and to describe the methods that will be employed to mitigate those hazards. The Health and Safety Plan must be prepared and approved by the Project Manager and the local Health and Safety Coordinator prior to initiating field work. A Health and Safety Meeting must be held at the start of each day to reassess any potential hazards associated with that day's field work.

3 Methods

This SOP has been prepared in accordance with the United States Environmental Protection Agency (USEPA) Standard Operating Procedure for Low-Stress (Low Flow)/Minimal Drawdown

Ground-Water Sample Collection, dated 2002. This guidance document is included as Attachment 3 of the Ground-Water Sampling Guidelines for Superfund and RCRA Project Managers, which may be found via the following internet link:

http://www.epa.gov/swertio1/tsp/download/gw_sampling_guide.pdf

This methodology described herein is also consistent with the California Environmental Agency's (Cal-EPA), Representative Sampling of Groundwater for Hazardous Substances, Guidance Manual for Ground Water Investigations, dated June 2005. This document may be found via the following internet link:

http://www.dtsc.ca.gov/SiteCleanup/upload/SMP_Representative_Sampling_GroundWater.pdf

Unlike traditional purging methods, low-flow purging and sampling does not require the removal of an arbitrary volume of water from a well prior to sampling. Instead, low-flow purging and sampling relies on careful monitoring of water quality indicator parameters to determine when a representative groundwater sample can be collected. The low-flow methodology minimizes the effects on groundwater chemistry caused by the purging process by minimizing drawdown, reducing the amount of water removed from the well, and reducing the amount of turbidity in groundwater samples.

4 Equipment and Materials

A non-exhaustive summary of common supplies and equipment is presented below:

- Health and Safety Plan
- Site information (maps, contact numbers, previous field logs, etc.)
- Electronic water level indicator (Solinst or similar)
- Photoionization Detector (PID) or Flame ionization detector (FID) if VOCs are suspected
- Adjustable-rate sampling pump capable of rates <0.5 liters per minute (bladder pump preferred, e.g., QED Sample Pro)
- Bladders for sample pump
- Sample tubing (Teflon® or Teflon®-lined tubing preferred for sampling organic compounds)
- Multi-parameter meter (e.g. YSI 556 Multi-Parameter Meter) with flow through cell capable of measuring (at a minimum) temperature, pH, specific electrical conductance (SEC), dissolved oxygen (DO), and oxidation-reduction potential (ORP)
- Turbidity meter
- In-line filters (if required, e.g. for dissolved metals)
- Certified-clean sample containers and preservation supplies, sample labels, Ziploc™ bags

- Cooler with ice
- Decontamination supplies (e.g. phosphate-free detergent, distilled water)
- Tool kit with appropriate tools (socket wrench set, pry bar, Dolphin locks/keys)
- Drum(s) to collect purged water and decontamination water
- Drum labels
- Person Protective Equipment (PPE), typically PPE will consist of:
 - Long-sleeved shirt and long pants
 - Steel-toed boots
 - Hardhat
 - Nitrile gloves
 - Safety glasses with side shields
 - Other as required by Health and Safety Plan
- Field Forms (If the project requires it, a project-specific Field Logbook may substitute for any of the following with the exception of the Chain of Custody)
 - *Field Investigation Daily Log*
 - *Water Level Measurement Log*
 - *Low-Flow Purging and Sampling Log*
 - *Equipment Calibration Log*
 - *Chain-of-Custody*

5 Procedures

The following sections discuss the procedures to follow during low-flow purging and sampling monitoring wells with dedicated or non-dedicated equipment (e.g., bladder pumps with adjustable rate controls). Where applicable and when possible, the purging and sampling techniques should remain consistent from one sampling event to the next.

5.1 Pre-Sampling Activities

1. Sampling should begin at the monitoring well with the least contamination, generally up-gradient or farthest from the site or suspected source. Then proceeding systematically to the monitoring wells with the higher expected groundwater concentrations.
2. All measuring devices and monitoring equipment should be calibrated according to manufacturer's recommendations. Water quality meters must be calibrated daily before use. Equipment calibration details should be recorded in the *Equipment Calibration Log*.
3. Unlock well and/or remove well cap. Record any damage or evidence of pressure (positive or negative) in the well in the Water Level Measurement Log. Monitor the headspace at the top of the well for VOCs with a PID or FID and record findings. If VOCs are present, monitor worker breathing zones during purging and sampling in accordance with the site

Health and Safety Plan.

4. Prior to sampling, the depth-to-water in all wells must be measured to obtain the current static water level. Water levels should be measured to the nearest 0.01 feet relative to a reference measuring point on the Top of Casing (TOC) which must be surveyed relative to ground elevation. If there is no marked reference point on the TOC, measure from the North side of the casing. Record depth to groundwater information in the *Water Level Measurement Log*. The same water level measuring device should be used for all wells, if possible, and must be decontaminated between each well.
5. Use existing site information for total depth (TD) of monitoring well and use the information from depth to water to calculate the volume of water in the monitoring well. The TD of wells to be sampled should not be tagged prior to sampling to avoid disturbing sediments at the bottom of the well. If possible, have this information prior to the day of sampling. The TD of wells should be verified after sampling. Record TD and water volume information in the *Low-Flow Purging and Sampling Log*.

5.2 Purging and Sampling

1. If using non-dedicated equipment, place the pump and support equipment at the well head and slowly lower the pump and tubing down into the monitoring well until the location of the pump intake is set at a predetermined location within the screen interval. Where possible, pre-measured tubing should be used to place the pump intake at the same depth as previous sampling events, or at a depth where there is known contamination within the screen interval. If there is no previous information for the well, the pump intake should be placed at the middle (or slightly above the middle) of the screen interval. Record the pump depth in the *Low-Flow Purging and Sampling Log*.
2. Measure depth to water to the nearest 0.01 feet relative to the reference measuring point on the TOC with an electronic water level indicator. Record depth to groundwater information in the *Low-Flow Purging and Sampling Log*. Leave water level indicator in the well.
3. Connect the discharge line from the pump to a flow-through cell that at a minimum measures temperature, pH, SEC, DO, and ORP. Turbidity measurements can be made using a separate turbidity meter. The discharge line from the flow-through cell must be directed to a container to hold purge water collected during purging and sampling of the well.
4. Start pumping the well at a flow rate of between 0.1 and 0.5 liters per minute (L/min) and slowly increase the flow rate. (For new wells or wells with no purging history, start at the lower end of that range.) Check the water level. Maintain a steady flow rate while maintaining a drawdown of less than 0.3 feet. (Zero drawdown is optimal, but infrequently achievable). If drawdown is greater than 0.3 feet, lower the flow rate; 0.3 feet is a goal to help guide with the flow rate adjustment. This goal will be difficult to achieve in some wells due to low hydraulic conductivities and limitations to the lowest flow rate a pump can produce while maintaining steady flow. This goal may be adjusted based on site-specific conditions and personal experience. See the Special Advisory at the end of these procedures.

5. Measure the discharge rate of the pump with a graduated cylinder and a stopwatch.

Also, measure the water level and record both flow rate and water level on the *Low-Flow Purging and Sampling Log*. Continue purging, monitor and record water level and pump rate every 3 to 5 minutes. Purging rates should be kept at minimal flow to ensure

minimal drawdown in the monitoring well.

6. A minimum of one tubing volume (including the volume of the water in the pump and flow cell) must be purged prior to recording the water quality indicator parameters. After this has been accomplished, monitor and record the water quality indicator parameters every three to five minutes in the *Low-Flow Purging and Sampling Log*. Stable readings of temperature, pH, SEC, DO, turbidity and ORP indicate when a representative sample can be collected. The stabilization criterion is based on three successive readings of the water quality indicator parameters as shown in Table 1. ORP may not always be an appropriate stabilization parameter and will depend on site-specific conditions. However, readings should be recorded because of its value for double-checking oxidizing conditions. The stabilization criterion is based on three successive readings of the water quality indicator parameters as shown in Table 1.

Parameter	Stabilization Criteria
Temperature	± 3% of reading (minimum of ±0.2° C)
pH	± 0.1 pH units
Specific Electrical Conductance (SEC)	± 3% S/cm
Dissolved Oxygen (DO)	± 0.3 milligrams per liter
Turbidity	± 10% NTUs (when turbidity is greater than 10 NTUs)
Oxidation-Reduction Potential (ORP)	± 10 millivolts

7. Maintain the same pumping rate or reduce slightly for sampling as necessary in order to minimize disturbance of the water column. Sampling should be collected directly from the discharge port of the pump tubing prior to passing through the flow-through cell. Disconnect the pump's tubing from the flow-through cell so that the samples are collected from the pump's discharge tubing. For samples collected for dissolved gases or VOC analyses, the pump tubing needs to be completely full of ground water to prevent the ground water from being aerated as it flows through the tubing. Generally, the sequence of the samples is immaterial unless filtered (dissolved) samples are collected. Filtered samples must be collected last (see below). All sample containers should be filled with minimal turbulence by allowing the ground water to flow from the tubing gently down the inside of the container. When filling VOC samples using volatile organic analysis (VOA) vials, a meniscus must be

formed over the mouth of the VOA vial to eliminate the formation of air bubbles and head space prior to capping. Effervescence and colorimetric reactions should be recorded in the *Low-Flow Purging and Sampling Log*.

8. If a filtered (dissolved) metal sample is to be collected, then an inline filter is fitted at the end of the discharge tubing and the sample is collected after the filter. The inline filter must first be flushed in accordance with manufacturer's recommendations and if there are no recommendations for flushing, a minimum of 0.5 to 1.0 liter of groundwater from the monitoring well must pass through the filter prior to sampling. (Note: Groundwater filter cartridges are dedicated sampling equipment. A new cartridge should be used at each sampling location. Do not attempt to clean filter cartridges. If the filter becomes clogged or groundwater flow is too slowed, remove and replace with a new filter cartridge.)
9. For non-dedicated systems, remove the pump from the monitoring well. Decontaminate the pump and dispose of the tubing. For dedicated systems, disconnect the tubing that extends from the plate at the wellhead (or cap) and discard after use.
10. Close and lock the well.

Special Advisory: If a stabilized drawdown in the well can't be maintained at 0.3 feet and the water level is approaching the top of the screened interval, reduce the flow rate or turn the pump off (for 15 minutes) and allow for recovery. It should be noted whether or not the pump has a check valve. A check valve is required if the pump is to be shut off during purging. Under no circumstances should the well be pumped dry. Begin pumping at a lower flow rate, if the water draws down to the top of the screened interval again, turn pump off and allow for recovery. If two tubing volumes (including the volume of water in the pump and flow cell) have been removed during purging, then sampling can proceed next time the pump is turned on. This information should be noted in the *Low-Flow Purging and Sampling Log*. This behavior may necessitate an alternative purging and sampling procedure for subsequent sampling events.

5.3 Equipment Decontamination

The electronic water level indicator and the water quality meters will be decontaminated by the following procedures:

1. The water level indicator will be hand washed with phosphate-free detergent and a scrubber, then thoroughly rinsed with distilled water, or steam-cleaned.
2. Water quality meter sensors and flow-through cell will be rinsed with distilled water between sampling locations. No other decontamination procedures are necessary or recommended for these meters since they are sensitive instruments. After the sampling event, the flow-through cell and sensors must be cleaned and maintained per the manufacturer's requirements.

Upon completion of the groundwater sample collection the sampling pump must be decontaminated between monitoring wells. The pump and discharge line including support cable and electrical wires which were in contact with the groundwater in the well

casing must be decontaminated by the following procedure:

1. The outside of the pump, tubing, support cable and electrical wires must be pressure-sprayed with soapy water, tap water and distilled water. Spray outside of tubing and pump until water is flowing off of tubing with each rinse. Use bristle brush to help remove visible dirt and contaminants.
2. Place the sampling pump in a bucket or in a short cylinder or well casing (4-inch diameter) with one end capped. The pump placed in this device must be completely submerged in the water. A small amount of phosphate-free detergent must be added with the potable (tap) water.
3. Remove the pump from the bucket or 4-inch casing and scrub the outside of the pump housing and cable.
4. Place pump and discharge line back in the container, start pump and re-circulate soapy water for approximately 2 minutes.
5. Re-direct discharge line to a 55-gallon drum. Continue to add 5 gallons of potable (tap) water.
6. Turn pump off and place pump into a second bucket of potable (tap) water. Continue to add 5 gallons of tap water.
7. Turn off and place pump into a third bucket which contains distilled/deionized water, continue to add 3 to 5 gallons of water.
8. If hydrophobic contaminants are present (such as separate phase (i.e. LNAPL or DNAPL, high levels of PCBs, etc.) an additional decontamination step, or steps, may be required.
9. Decontamination water will be collected and stored on-site for future disposal by the client unless other arrangements have been made.

6 Quality Control Samples

All field Quality Control (QC) samples must be prepared the same as primary samples with regard to sample volume, containers, and preservation. The sample handling and chain-of-custody procedures for the QC samples will be identical to the primary samples. The following are QC samples that may be collected during groundwater sampling:

- A field duplicate is an independent sample collected as close as possible to the same time that the primary sample is collected and from the same source. Field duplicates are used to document sample precision. Field duplicates will be labeled and packaged in the same manner as primary samples so that the laboratory cannot distinguish between the primary sample and the duplicate sample. Field duplicates are analyzed for the same suite of parameters as the primary samples. The frequency of analysis of field duplicates is generally one for every 20 primary samples, but may vary depending on project requirements.
- Equipment blanks are obtained by running distilled or deionized water over or through the sample collection equipment after it has been decontaminated, and capturing the water in

the appropriate sample containers for analysis. Equipment blanks are analyzed for the same suite of parameters as the primary samples. The frequency of analysis of equipment blanks is generally one for every day that non-dedicated sampling equipment is used, but may vary depending on project requirements.

- Field blanks are used to assess the presence of contaminants arising from field sampling procedures. Field blank samples are obtained by filling a clean sampling container with reagent-grade deionized water. Field blanks are analyzed for the same suite of parameters as the primary samples. Field blanks may or may not be incorporated into a groundwater sampling plan depending on project requirements.
- Trip blanks are sample containers that are used to evaluate sample cross-contamination of VOCs during shipment. For groundwater sampling, trip blanks consist of hydrochloric acid-preserved, analyte-free, deionized water prepared by the laboratory in VOA vials that will be carried to the field, stored with the samples, and returned to the laboratory for VOC analysis. Generally, one trip blank is required to accompany each sample shipping container or cooler that contains samples for VOC analysis; however, this may vary depending on project requirements.

7 Sample Handling and Custody

Samples will be collected, handled, and stored in such a manner that they are representative of their original condition and chemical composition. Identification of samples and maintenance of custody are important elements that must also be utilized to ensure samples characterize site conditions. All samples will be properly identified and maintained under chain-of-custody protocol to protect sample integrity. The following sections discuss the sample handling and custody requirements.

7.1 Sample Identification

To maintain consistency, a sample identification convention including unique identifiers for all groundwater and QC samples must be developed and followed throughout the project. The sample identifiers will be entered onto the sample labels, field forms, chain-of-custody forms, and other records documenting sampling activities.

7.2 Sample Labels

A sample label will be affixed to all sample containers sent to the analytical laboratory. Field personnel will complete an identification label for each sample with the following information written in waterproof, permanent ink:

- Client and project number;
- Sample location and depth, if relevant;
- Unique sample identifier;
- Date and time sample collected;
- Filtering performed, if any;
- Preservative used, if any;
- Name or initials of sampler; and

- Analyses or analysis code requested.

The use of pre-printed sample labels is preferred in order to reduce sample misidentification problems due to transcription errors. Sample labels must be completed and affixed to the sample container in the field at the time of sample collection.

If errors are made on a sample label, corrections will be made by drawing a single line through the error and recording the correct information. Corrections will be dated and initialed.

7.3 Containers, Preservation, and Hold Time

Each lot of preservative and sampling containers will be certified as contaminant-free by the supplier. All preserved samples will be clearly identified on the sample label and *Chain-of-Custody* form. If samples requiring preservation are not preserved, field records will clearly specify the reason for the discrepancy.

Chemical activity continues in the sample until it is either analyzed or preserved. Once the sample has been preserved, the sample may be held for a period of time before analysis. The time from the collection of the sample to the analysis is defined as the holding time. The holding time varies depending on the media being sampled and the analyses being performed. The collection, preservation, and analysis of samples must be conducted to avoid exceeding relevant holding times.

7.4 Sample Handling and Transport

Proper sample handling techniques are used to ensure the integrity and security of the samples. Samples for field measured parameters will be analyzed immediately in the field and recorded in the appropriate field forms. Samples for laboratory analysis will be transferred immediately to appropriate laboratory supplied containers in accordance with the following sample handling protocols:

- Don clean gloves before touching any sample containers, and take care to avoid direct contact with the sample;
- Samples will be quickly observed for color, appearance, and composition and recorded as necessary;
- The sample container will be labeled before or immediately after sampling;
- Sample containers and liners will be capped with Teflon™-lined caps before being placed in Ziploc™-type plastic bags. The samples will be placed in an ice chest kept at 4 °C for transport to the laboratory;
- All sample lids will stay with the original containers, and will not be mixed;
- Sample bottles will be wrapped in bubble wrap as necessary to minimize the potential for breakage during shipment; and
- The *Chain-of-Custody* form will be placed in a separate plastic bag and taped to the cooler lid or placed inside the cooler. A custody seal will be affixed to the cooler if the samples are to be shipped by commercial carrier. For shipped samples, U.S. Department of Transportation shipping requirements will be followed and the sample shipping receipt will

be retained in the project files as part of the permanent Chain-of-Custody document.

7.5 Sample Chain-of-Custody

Sample chain-of-custody procedures will be used to maintain and document sample integrity during collection, transportation, storage, and analysis. A sample is considered to be under the control of, and in the custody of, the responsible person if the samples are in their physical possession, locked or sealed in a tamper-proof container, or stored in a secure area.

The *Chain-of-Custody* form provides an accurate written record that traces the possession of individual samples from the time of collection in the field until they are accepted at the analytical laboratory. The *Chain-of-Custody* form also documents the samples collected and the analyses requested. The sampler will record the following information on the *Chain-of-Custody* forms:

- Client and project number;
- Name or initials and signature of sampler;
- Name of destination analytical laboratory;
- Name and phone number of Project Leader in case of questions;
- Unique sample identifier for each sample;
- Data and time of collection for each sample;
- Number and type of containers included for each sample;
- Analysis or analyses requested for each sample;
- Preservatives used, if any, for each sample;
- Sample matrix for each sample;
- Any filtering performed, if applicable, for each sample;
- Signatures of all persons having custody of the samples;
- Dates and times of transfers of custody;
- Shipping company identification number, if applicable; and
- Any other pertinent notes, comments, or remarks.

Blank spaces on the *Chain-of-Custody* will be crossed out and initialed by the field sampler between the last sample listed and the signatures at the bottom of the sheet.

The field sampler will sign the *Chain-of-Custody* and will record the time and date at the time of transfer to the laboratory or an intermediate person. A set of signatures is required for each relinquished/received transfer, including internal transfer. The original imprint of the *Chain-of-*

Custody will accompany the sample containers and a duplicate copy will be kept in the project file.

If the samples are to be shipped to the laboratory, the original *Chain-of-Custody* relinquishing the samples will be sealed inside a plastic bag within the ice chest, and the chest will be sealed with

custody tape that has been signed and dated by the last person listed on the *Chain-of-Custody*. U.S. Department of Transportation shipping requirements will be followed and the sample shipping receipt will be retained in the project files as part of the permanent *Chain-of-Custody* document. The shipping company (e.g., Federal Express, UPS) will not sign the *Chain-of-Custody* forms as a receiver; instead the laboratory will sign as a receiver when the samples are received.

8 Field Documentation

Information collected during groundwater sampling may be recorded on individual field forms. If the project requires it, a project-specific Field Logbook may replace any of the individual field forms with the exception of the *Chain-of-Custody* form. Following review by the Project Manager, the original field records will be kept in the project file. The following forms may be used to document the field activities:

- *Field Investigation Daily Log*
- *Water Level Measurement Log*
- *Low-Flow Purging and Sampling Log*
- *Equipment Calibration Log*
- *Chain-of-Custody*

The *Field Investigation Daily Log* will be completed for each day of fieldwork containing (at a minimum) the times and descriptions of the work performed, the activities of the drillers and any other subcontractors or visitors on-site, arrival and departure times for all involved, and any other pertinent information. For larger projects, or when otherwise deemed appropriate by the Project Manager, this information may alternatively be recorded in a Field Logbook. In these cases, a separate Field Logbook must be used for each project or site.

The *Water Level Measurement Log* will be used to record water level measurements for all wells prior to commencement of groundwater sampling. The type, serial number, and calibration date for the water level measuring device will be included on this form. Additionally, this form will be used to record general observations of the conditions of the wells, wellheads, well boxes, and/or monuments.

The *Low-Flow Purging and Sampling Log* will be used to record the details of purging and sampling information for each well including the depth of the pump, purge rates, and volume purged from each well. This form will also be used to record all of the measurements of drawdown and water quality indicator parameters used for evaluating stabilization.

The *Equipment Calibration Log* will be used to document the calibration and status of any measuring instruments used in the field, e.g., PID/FID, water level measuring device, water quality meters, etc. The frequency and method of calibration will depend on the instrument. Any instruments used will be used in accordance with the factory-provided operating and/or service manuals.

Locations and unique identification of water samples collected from the monitoring wells will be

recorded on the *Field Investigation Daily Log*, *Low-Flow Purging and Sampling Log*, a site map, and/or other appropriate forms.

Samples names, date/times, analyses to be performed, and other pertinent information will be recorded on the *Chain-of-Custody* form (discussed in Section 7.5) as a means of identifying and tracking the samples.

9 References

United States Environmental Protection Agency (USEPA). 2002. Standard Operating Procedure for Low-Stress (Low Flow)/Minimal Drawdown Ground-Water Sample Collection.

Puls, Robert W. and Michael J. Barcelona. 1996. Low-Flow (Minimal Drawdown) Ground-Water Sampling Procedures. April.

California Environmental Agency's (Cal-EPA) Representative Sampling of Groundwater for Hazardous Substances. 2005. Guidance Manual for Ground Water Investigations, June.

Soil Moisture Lysimeter Operating Instructions

April 2014

**Soil Moisture Equipment Corporation
ENVIRON International Corporation**

Attachment:

Soilmoisture Equipment Corp. 2011. 1920F1 Pressure-Vacuum Soil Water Sampler Operating Instructions. November. (16 pages)

1920F1

OPERATING INSTRUCTIONS

1920F1 Pressure-Vacuum Soil Water Samplers

November 2011

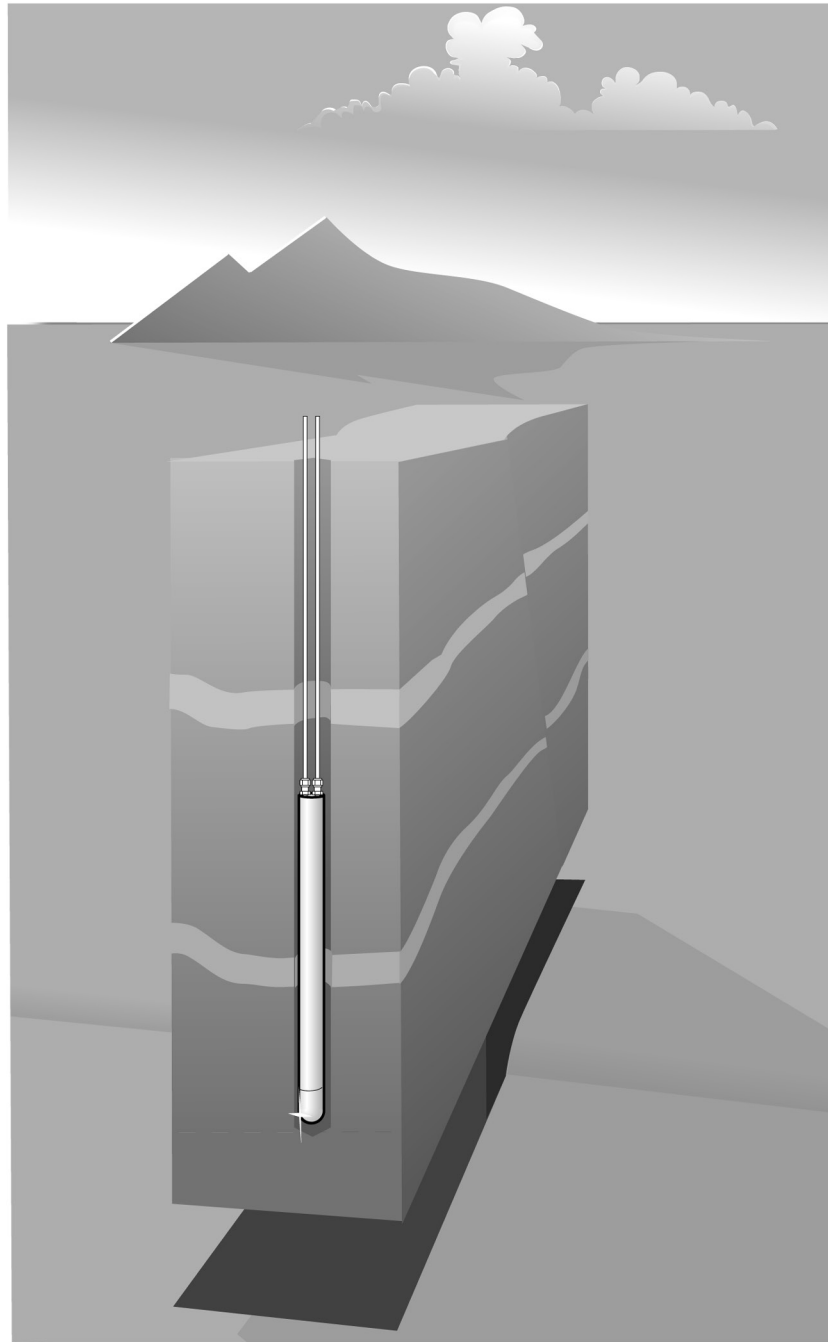

SOILMOISTURE EQUIPMENT CORP.
P.O. Box 30025, Santa Barbara, California 93130 USA
Phone: (805) 964-3525 • Fax: (805) 683-2189
e-mail: sales@soilmoisture.com • Web www.soilmoisture.com



TABLE OF CONTENTS

History/General Uses	Page 3
Operating Principles	Page 4
Your New Pressure-Vacuum Soil Water Sampler.....	Page 6
Unpacking	Page 6
Assembly	Page 6
Not Liable for Improper Use.....	Page 7
Acquaint Yourself with the Parts	Page 8
Requirements Prior to Use and How to Operate	Page 8
Attaching the Access Tubes.....	Page 8
Pressure Testing Before Installation	Page 8
Coring the Hole	Page 8
Preparing The Hole Using a Slurry and Backfilling The Hole	Page 9
Alternate Methods for Sampler Installation	Page 10
Protecting the Access Tubes.....	Page 12
Collecting a Sample in the Sampler.....	Page 12
Recovering a Sample from the Soil Water Sampler	Page 13
Maintenance and Precautions	Page 14
Re-wetting The Sampler	Page 14
Spare Parts and Accessories	Page 15

HISTORY/GENERAL USES

Soil Water Samplers had their origin back in 1961 when we cooperated with Dr. George H. Wagner at the University of Missouri to manufacture a porous ceramic cup for collecting soil water samples. The outgrowth of this work was our first commercial Soil Water Sampler, Model 1900 Soil Water Sampler. Since that time, these samplers have been generally accepted as an ideal tool for in situ collection of soil water samples for a great variety of soil moisture monitoring work.

The initial and most extensive use of these Samplers was made by Pennsylvania State University, largely under the direction of Dr. L. T. Kardos and others, on the Pennsylvania Waste Water Project. Modifications of the original 1900 Soil Water Sampler by Richard R. Parizek and Burke E. Lane at Pennsylvania State University, reported on in the Journal of Hydrology, produced a pressure-vacuum type unit. Since that time, we have made available commercially the Model 1920 Pressure-Vacuum Soil Water Sampler. Some of our Soil Water Samplers have been in continuous use for several years and still yield satisfactory soil moisture samples.

All of our ceramics are made from formulations which contain various proportions of kaolin, talc, alumina, ball clay, and other feldspathic materials, using proprietary formulas developed through research and experience accumulated over more than 4 decades.

Our samplers find applications not only in research work such as quantitative chemical analysis of soil water, but also for pollution control purposes in monitoring moisture under sanitary landfills, irrigated areas with wastewater, and areas where reclaimed or recycled water is used on a routine basis to assure compliance with government standards.

Soilmoisture's line of Soil Water Samplers has proven to be an excellent and reliable means for obtaining soil water samples from both saturated and unsaturated soils at depths ranging up to several hundred feet. Soilmoisture's Soil Water Samplers, which are also referred to as "suction lysimeters" or "lysimeters", have

OPERATING PRINCIPLES

been in general use around the world for many years.

Soil water is held largely under a state of tension (negative pressure) within the soil by capillary forces. The capillary force is the sum of the adhesive and cohesive forces. The adhesive force is characterized as the attraction of water for soil solids (soil and organic matter). Cohesive force is characterized as the attraction of water for itself. Adhesive force is far greater than the cohesive force.

Water is naturally attracted to soil particles (by its adhesive quality) and “sticks” to the surface of each particle and in the various sized “capillary” spaces or “pores” between the soil particles. When the soil is very wet, the large pores fill with water. This “excess” water has no direct surface contact with the soil and is held cohesively, one water molecule to another, and can move quite freely. As a soil dries out, the “excess” water first evaporates as it requires less energy to break the cohesive bonds. The remaining water, held tightly inside the capillary spaces by adhesive qualities, requires more energy to remove it from the soil.

The following illustration (see Figure 1) shows the increasing force required to remove water from the small-sized capillary pores compared to the large pores as the soil dries out. When the remaining water is held only in extremely small pore spaces, it requires more energy to remove the water from these pores. Even though there may be a considerable volume of water in the soil, the tension that holds the water determines how readily it can be removed.

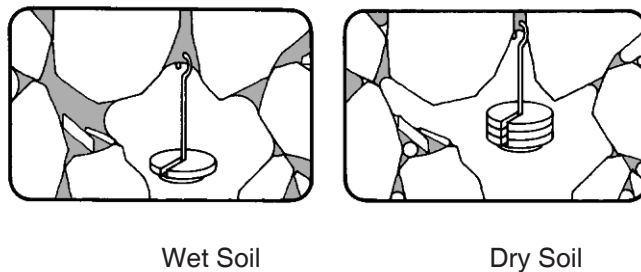

Figure 1.

This tension that determines how moisture moves in the soil is referred to as “soil water tension”, “negative pore pressure”, or “soil suction”. For simplicity’s sake we refer to this tension as “soil suction” in these instructions, but keep in mind that negative pressure is the most descriptive term.

The following graph shows the relationship between the percent of moisture in a soil and the soil suction required to remove the moisture from three types of soil: clay, loam, and sand.

The graph (see Figure 2) illustrates that it is easier to remove water from a sandy soil with 10% moisture, than it is to remove water from a clay soil with 30% moisture. This is because the water in the clay soil is held in very small capillary spaces within the soil particles under a higher soil suction, whereas the sandy soil holds water in large capillary spaces under a lower soil suction.

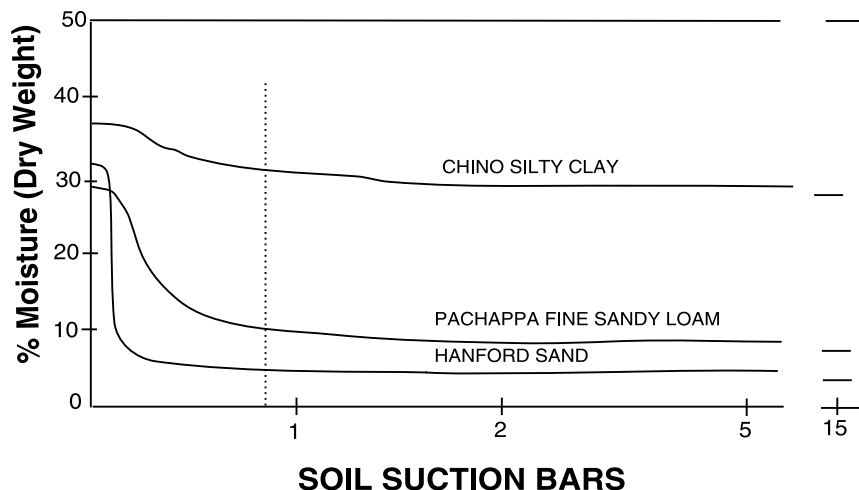

Figure 2.

Soilmoisture's Soil Water Samplers allow water to be removed from the soil by creating a vacuum (negative pressure or suction) inside the sampler greater than the soil suction holding the water in the capillary spaces. This establishes a hydraulic gradient for the water to flow through the porous ceramic cup and into the sampler. Note: when evaluating soil suction ratings of a ceramic plate or cup, a positive pressure rating is used. Water can be held at tensions far greater than 1 atm (the limit for vacuum-type measurements). Positive pressure can force water out of capillary pores equivalently as negative pressures, and is the practical method for evaluation of soil suction.

In practice, a vacuum is drawn in the Soil Water Sampler that exceeds the soil water tension. Then liquid water will flow to the ceramic cup due to the potential gradient (i.e. water will move from less negative potential to more negative potential). The practical limit for water flow in soils is about 65 cb (centibar) (although in some soils, the value can approach 85 cb). When soil moisture tensions exceed 2 bars, the wetted meniscus in the ceramic pores will break and the Soil Water Sampler will appear to be unable to hold vacuum. The ceramic cup will have to be rewetted to hold a vacuum and soil moisture tensions will have to decrease to less than 85 cb before water can again be moved toward the ceramic cup.

Additional information on the advantages and disadvantages of Soil Water Samplers in general can be found in Chapter 19, "Compendium of In Situ Pore-Liquid Samplers for Vadose Zone" (Dorrance et al.), of the ACS Symposium on Groundwater Residue Sampling Design (April 22-27, 1990) and the ASTM Designation D4696-92 "Standard Guide for Pore-Liquid Sampling from the Vadose Zone" (Vol. 04.08 Soil and Rock (I): D4696).

YOUR NEW PRESSURE-VACUUM SOIL WATER SAMPLER

Unpacking

Remove all packing materials and check the Soil Water Sampler for any damage that may have occurred during shipment.

If the Sampler is damaged, call the carrier immediately to report it. Keep the shipping container and all evidence to support your claim.

Assembly

The standard 1920F1 Pressure-Vacuum Soil Water Sampler was assembled and tested prior to shipment.

All other accessory items necessary for proper use are discussed later in these instructions and are listed on page 16. Please read all instructions thoroughly before installing the Sampler. To assure optimum cleanliness of the assembly, no grease or organic solvents have been used in its manufacture.

Not Liable for Improper Use

Soilmoisture Equipment Corp. is not responsible for any damage, actual or inferred, for misuse or improper handling of this equipment. The Pressure-Vacuum Soil Water Samplers, Models 1920F1, are to be used solely as directed by a prudent individual under normal conditions in the applications intended for this equipment.

ACQUAINT YOURSELF WITH THE PARTS

The Pressure-Vacuum Soil Water Sampler (Model 1920F1) comes fully assembled. The Pressure-Vacuum Soil Water Sampler (see Figure 3) is constructed of a 1.9 inch O.D. PVC tube (made of FDA-approved material) with a 2 bar porous ceramic cup bonded to one end. The serviceable end of the Sampler is completely sealed and two 1/4-inch tube connectors protrude from the top. The white tube connector indicates the "Pressure/Vacuum" side and is used exclusively for pressurizing and evacuating the Sampler. The green tube connector is used to recover the collected sample.

Two 1/4-inch O.D. polyethylene access tubes are used for pressurizing and recovering samples which are terminated in neoprene tubing. Clamping rings are used to clamp the neoprene to keep the Sampler under negative pressure (not shown here).

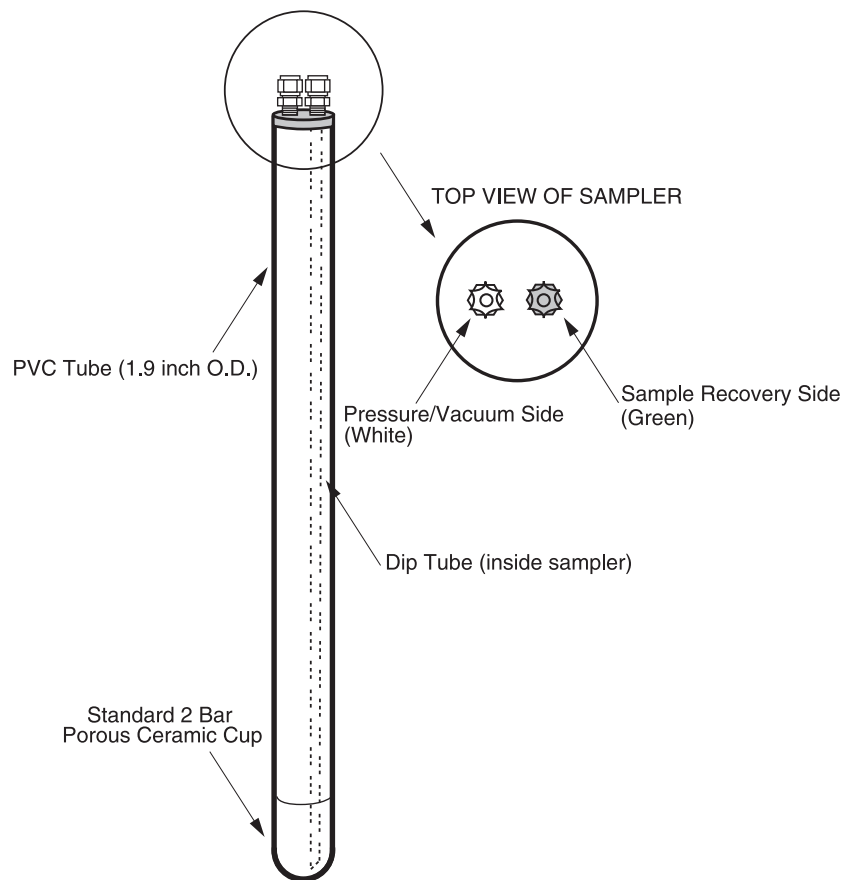

Figure 3. Pressure-Vacuum Soil Water Sampler

REQUIREMENTS PRIOR TO USE AND HOW TO OPERATE

Attaching the Access Tubes

Once the depth and location for the Pressure-Vacuum Soil Water Sampler have been established, you must determine the required length for the access tubes before they are cut and attached to the Soil Water Sampler.

The access tubes are generally made of 1/4-inch O.D. polyethylene, nylon, or teflon tubing. Each access tube is inserted into the loosened top portion of the tube connector located on the serviceable end of the Soil Water Sampler. Tighten the fittings to finger tightness. We recommend using 2 different colors of tubing to differentiate between the two connectors in order to eliminate mistakes in identifying the access tubes once the Sampler is placed in the soil. Soilmoisture offers both black and green polyethylene tubing, models 1903L and 1904L respectively.

Pressure Testing Before Installation

We highly recommend pressure testing the complete Sampler assembly prior to installation. Your prior testing will confirm the integrity of all joints and components.

After allowing the ceramic portion of the Sampler to soak in water for approximately two hours, a sustained pressure of 20 psi can be applied to the submerged Sampler, associated tubing, and connectors. Continuous bubble formation indicates leakage and shows the exact location of any leak.

Coring the Hole

The Pressure-Vacuum Soil Water Sampler, Model 1920F1, may be installed at any depth up to a maximum of 50 feet.

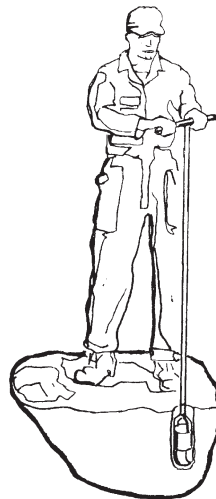

Figure 4a.



Figure 4b.

In rock-free, uniform soils at shallow depths, use a 2-inch screw or bucket auger for coring the hole (Figure 4a). If the soil is rocky, a 4-inch auger should be used. The soil is then sifted (Figure 4b) through a 2mm mesh screen or 2mm sieve to free it of pebbles and rocks.

This will provide a reasonably uniform backfill soil for filling in around the Soil Water Sampler. Soilmoisture has suitable soil augers for this purpose (234 Series augers). There are other methods for installing the Soil Water Sampler to be used, largely dictated by the type of soil you are dealing with and the tools available. The primary concern in any method of installation is that the porous ceramic cup of the Sampler be in tight, intimate contact with the soil so that soil water can move readily from the pores of the soil through the pores in the ceramic cup and into the Soil Water Sampler.

Preparing The Hole Using a Slurry and Backfilling The Hole

After the hole has been cored, mix sifted soil with water to make a slurry which has a consistency of cement mortar. This slurry is then poured down to the bottom of the cored hole to insure a good soil contact with the porous ceramic cup (see Figure 5a).

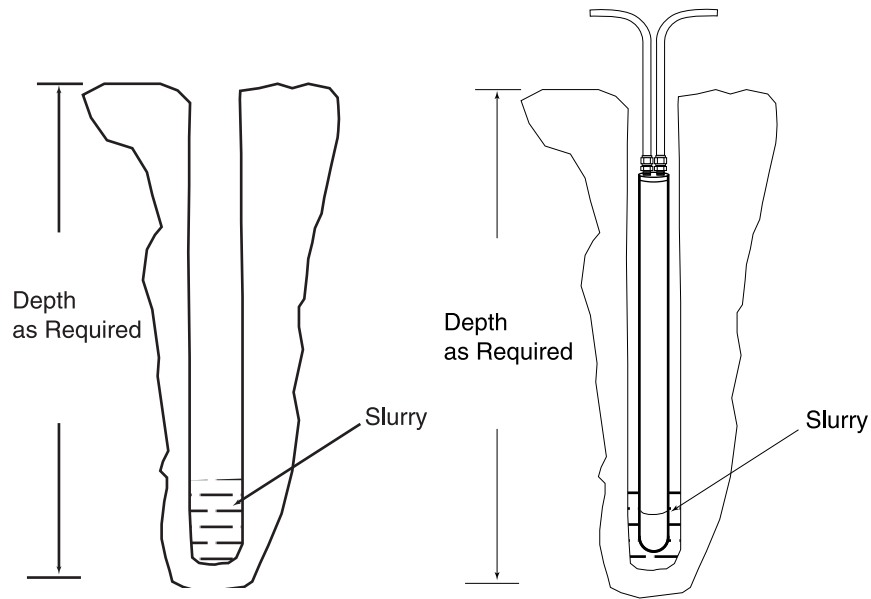

Figure 5a.

Figure 5b.

Immediately after the slurry has been poured, insert the Soil Water Sampler down into the hole so that the porous ceramic cup is completely embedded in the soil slurry (see Figure 5b).

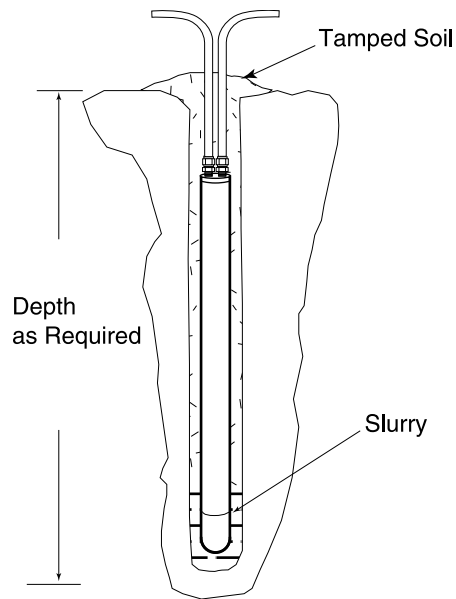

Figure 6.

Backfill the remaining area around the Sampler with sifted soil which is free of pebbles and rocks, a 2mm sieve is popular for this. Tamp the soil firmly to prevent surface water from running down the cored hole, or make a bentonite seal. (see Fig. 6)

Alternate Methods for Sampler Installation

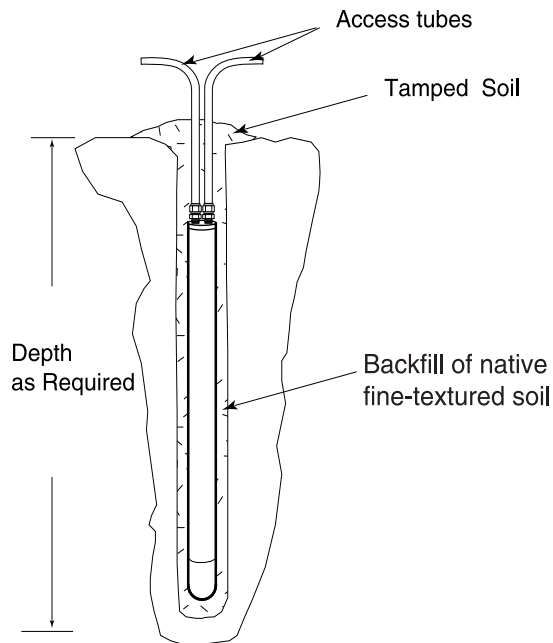

Figure 7.

If the soil into which the Sampler is being installed is fine-textured and free of rocks, a slurry may not be necessary. Core the hole to the desired depth, insert the Soil Water Sampler and backfill the hole with native soil, tamping continuously to insure good soil contact with the porous ceramic cup and complete sealing of the cored hole (see Figure 7).

In a coarse-textured or rocky soil, it may be difficult to make a suitable slurry from the existing soil. A slurry can be made using silica flour, which is then used to establish good contact between the ceramic cup and the soil. For a 2-inch diameter hole, 1 lb. of silica flour is needed, while a 4-inch diameter hole will require 4 lbs. of silica. Mix the silica with water to produce a slurry with a consistency of cement mortar.

Core the hole to the desired depth, and pour in about 1/4 of the silica slurry. Insert the Soil Water Sampler and pour in the remainder of the slurry so that the slurry completely covers the ceramic cup. Backfill the hole with sifted soil (free of pebbles and rocks), tamping continuously with a metal rod to prevent surface water from channeling down between the soil and the body tube of the Sampler (see Figure 8).

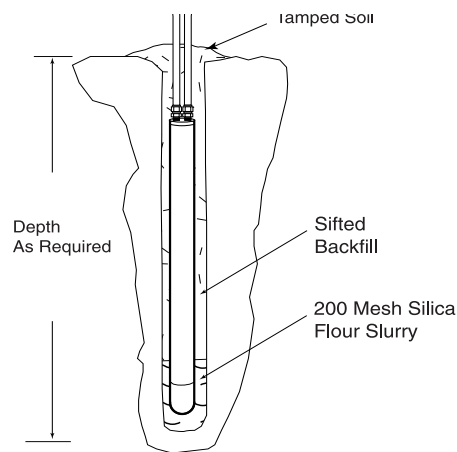

Figure 8.

To ensure that disturbed soil resulting from the installation of the Sampler does not affect the movement of water to the Sampler, Bentonite clay plugs can be installed. Core the hole a few inches deeper than the desired depth, and pour in several inches of wet Bentonite clay (see Fig. 9). This will isolate the Sampler from the soil below. Pour in 1/4 of the slurry, either of soil or of Silica, and insert the Soil Water Sampler. Pour the remainder of the slurry around the cup of the Soil Water Sampler. Backfill with native soil to a level just above the Soil Water Sampler and again add sufficient Bentonite as a plug to further isolate the Soil Water Sampler and guard against possible channeling of water down the hole. Backfill the remainder of the hole slowly, tamping continuously with a metal rod using native soil, free of pebbles and rocks.

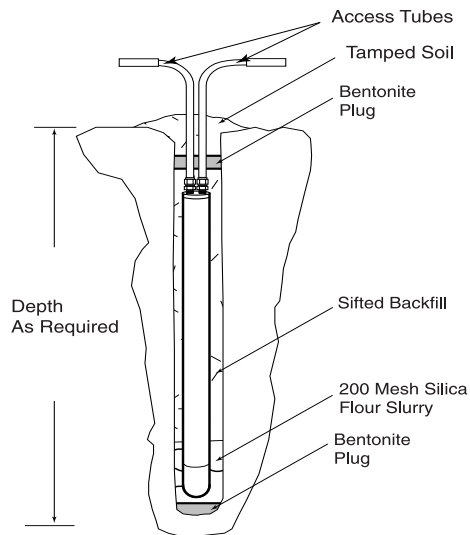

Figure 9.

Protecting the Access Tubes

After installation, the access tubes from the Sampler are terminated with a 6-inch length of neoprene tubing (MRT003) above the Sampler installation. Or, if conditions require, place the neoprene-terminated access tubes in a trench, terminating above the soil surface at a remote location. We recommend that the access tubes be protected inside a conduit tube running from the top of the Sampler to the termination at the surface. At the surface level, take care that the access tubes are safe from damage by mechanical equipment or animals. Do not cover the surface area directly above the Sampler in any manner that would interfere with the normal percolation of soil water down to the depth of the Sampler, otherwise the obstruction could have an adverse affect on your soil water sample.

Collecting A Sample in the Sampler

To collect a sample, the discharge access tube is closed using a clamping ring, and the vacuum port of the hand pump is connected to the Pressure-Vacuum access tube. The pump is then used to create a vacuum of about 60 cb inside the Sampler, which is indicated on the gauge connected to the pump (see Fig. 10).

Figure 10.

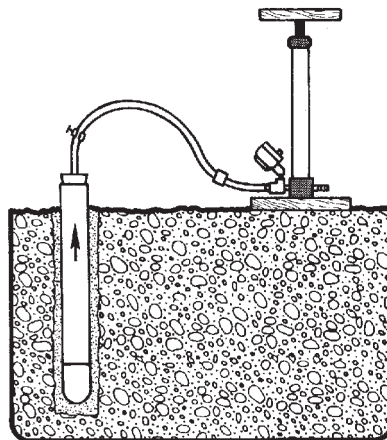

The vacuum within the Sampler causes the water to move from the soil, through the pores of the porous ceramic cup, and into the Sampler. The rate at which the soil

solution will collect within the Sampler depends on the capillary conductivity of the soil, the soil suction value within the soil (as measured with tensiometers), and the amount of vacuum within the Sampler. In moist soils of good conductivity, at field capacity (10 to 30 cb of soil suction as read on a tensiometer) substantial soil water samples can be collected within a few hours. Under more difficult conditions it may require several days to collect an adequate sample.

In general, a vacuum of 50 to 85 cb is normally applied to the Soil Water Sampler. In very sandy soils, however, it has been noted that very high vacuums applied to the Soil Water Sampler seem to result in a lower rate of collection of the sample than a lower vacuum. It is our opinion that in these coarse, sandy soils, the high vacuum within the Sampler may deplete the moisture in the immediate vicinity of the porous ceramic cup reducing the capillary conductivity, which creates a barrier to the flow of water to the cup. In loams and gravelly clay loams, users have reported collection of 300 to 500 ml of solution over a period of a day with an applied vacuum of 50 cb, when soils are at field capacity. At waste water disposal sites, users have obtained 1500 ml of sample solution in 24 hours following cessation of irrigation with 1 to 2 inches of waste water on sandy or clay loam soil.

To recover a soil water sample, remove the Pressure-Vacuum tube from the vacuum port of the pump, and attach the tube to the pressure port. Place the discharge access tube in a small collection bottle and remove both clamping rings. Apply a few strokes on the hand pump to develop enough pressure within the Sampler to force the collected water out of the Sampler and into the collection bottle (see Fig. 11).

Recovering a Sample from the Soil Water Sampler

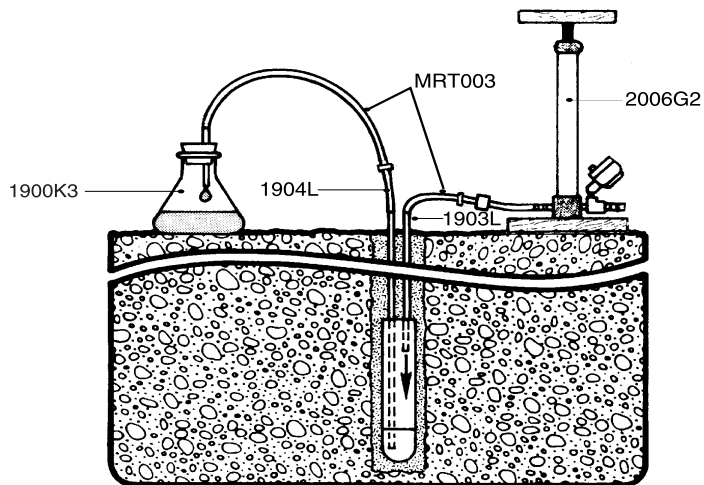

Figure 11.

Subsequent samples are collected by again creating a vacuum within the Sampler and following the steps as outlined above.

MAINTENANCE AND PRECAUTIONS

There are no maintenance requirements for the Pressure-Vacuum Soil Water Sampler other than protecting the access tubes from damage. Tube ends should be covered or plugged to prevent debris from entering the tubes and later contaminating the Sampler.

Freezing conditions will not damage the subsurface parts of the Samplers. The Samplers are normally left permanently in place all year round. Water may freeze in the sample line near the surface during saturated freezing conditions. Be sure all the water is removed from the sample line before clamping it for the next sample.

Rewetting The Sampler

If the soil suction exceeds 2 bars, the ceramic cup may need to be rewetted to obtain a sample. This is accomplished by pouring approximately 250 ml of deionized water down the sample line (both the pressure-vacuum and the sample lines must be open). After waiting approximately one hour, pressurize the pressure-vacuum line to remove any excess water. A vacuum can be applied after the ceramic cup has been rewetted. If no sample is obtained after following the above rewetting procedure, the soil suction is probably in excess of 85 cb.

SPARE PARTS AND ACCESSORIES LIST

0922W_	Bentonite (5 lb., 10 lb., or 50 lb. bag sizes)
0930W_	Silica Flour (5 lb., 10 lb., or 50 lb. bag sizes)
1900K4	Wide-mouth Sample Bottle, polypropylene - 1,000 ml (autoclavable)
1902K3	Centralizer with Centralizer Adapter Kit
1902K4	1-1/2" Stainless Steel Coupling Assembly
1903L_	Black Polyethylene Tubing (100 ft., 500 ft., or 1,000 ft. rolls)
1904L_	Green Polyethylene Tubing (100 ft., 500 ft., or 1,000 ft. rolls)
2006G2	Pressure-Vacuum Hand Pump (with gauge)
2031G2	Clamping Rings (per doz.)
MRT003	Neoprene Tubing, 3/16-inch I.D. x 1/16-inch wall (10ft, 25ft, or 50ft, rolls)

Note:

All Pressure-Vacuum Soil Water Samplers come in 6-inch, 12-inch, 24-inch or 36-inch lengths. They can also be special ordered with either a 1 Bar High Flow (30 ft. maximum depth range) or 1/2 Bar Standard (15 ft. maximum depth range) porous cup instead of the standard 2 Bar cup. Please contact our Sales Department for further details.

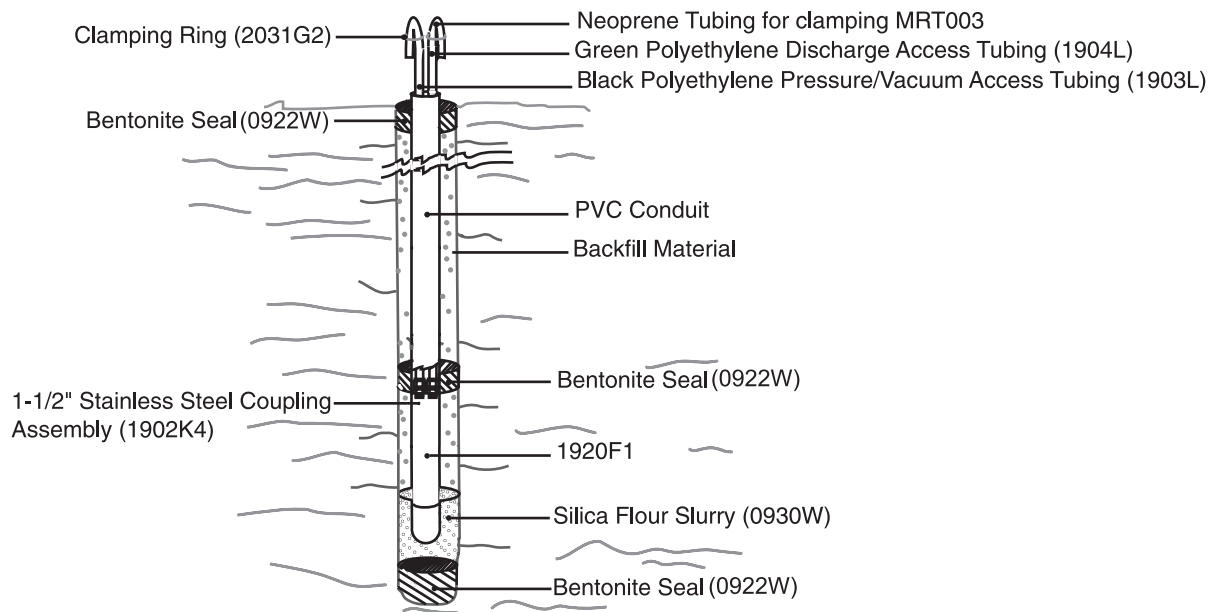

Figure 12. Complete sampler installation with accessories



Appendix C

Groundwater Mounding Estimates

APPENDIX C: Estimated Infiltration Rate for the Pilot Test

The rate at which water is applied during the Pilot Test will depend on the characteristics of the subsurface. An estimate of the maximum soil flushing rate and the rate to minimize unacceptable groundwater mounding has been completed using available data. This estimate will be refined once additional data has been collected as discussed in Section 5 of the Work Plan.

INFILTRATION RATE

Green-Ampt Model:

The Green-Ampt Model, derived from Darcy's Law, is a method of estimating the maximum infiltration rate of water into soil without generating runoff. The model is also implemented to determine hydraulic parameters, such as design flow rates. The equation is shown below:

Equation 1

$$f_p = \frac{K_{sat}(H + S_f + L)}{L}$$

Where:

f_p = The infiltration rate (L/T)

K_{sat} = Saturated hydraulic conductivity (L/T)

H = Recharge basin head at discharge point (L)

S_f = Suction (capillary) head at wetting front (L) = .97 to 25.36 cm for sands

L = Depth to wetting front (L)

During initial unsteady conditions, the suction head and effective hydraulic conductivity is expected to remain constant for simplicity with only the depth to the wetting front and infiltration rate varying with time. If the recharge basin water depth is held constant for all time, the depth of the wetting front will migrate downward until it reaches the natural water table where suction head will approach zero. When this occurs, the depth of the wetting front will reach a final value equal to the depth to the water table from the recharge basin bottom. Thus, the following equation will result for steady state infiltration due to a constant head recharge basin as the infiltration rate reaches a steady value:

Equation 2

$$f_p = \frac{K_{sat}(H + L)}{L}$$

Data:

To calculate the maximum possible flushing rate, data for K_{sat} and L were compiled from past investigations. The nearest groundwater monitoring well, M-111A, was removed as a part of the 2010/2011 soil removal action at the Site. The most recent water level at M-111A was 1734.5 feet above mean sea level on June 11, 2010 (Northgate, 2010). This result matches with groundwater contours based on more recent data which indicate that the groundwater elevation in the proposed pilot test location is approximately 1735 feet above mean sea level. The final

grade in the proposed soil flushing pilot test location is 1757 feet above mean sea level. Using the approximate water level data and the final grade, the depth to groundwater, L in equation 2, is approximately 22 feet bgs.

Saturated vertical hydraulic conductivity of soils in the proposed pilot test location is not currently known. Therefore, saturated vertical hydraulic conductivities and porosities were taken from Qal soils at the site in an effort to match the depths and lithology over which the soil flushing system will function in the vadose zone. This data is shown below:

Table 1. QAL Soil Matrix Data at Similar Depths to the Proposed Soil Flushing Pilot

Porosity and Vertical Hydraulic Conductivity					
Well ID	Depth (ft bgs)	Lithology	Porosity (-)	Vertical Hydraulic Cond. (ft/d)	Test Method
RSAL6-0.5BSPLP	0.5	Qal	0.36	1.75E-01	Lab (ASTM D5084)
RSAU5-0.5BSPLP	0.5	Qal	0.34	2.60E-02	Lab (ASTM D5084)
RSAR3-0.5BSPLP	0.5	Qal	0.37	2.67E-01	Lab (ASTM D5084)
SA30-9BSPLP	9	Qal	0.33	5.91E-01	Lab (ASTM D5084)
SA56-10BSPLP	10	Qal	0.38	4.24E+00	Lab (ASTM D5084)
RSAM3-10BSPLP	10	Qal	0.40	3.37E-01	Lab (ASTM D5084)
SA166-10BSPLP	10	Qal	0.36	4.54E-01	Lab (ASTM D5084)
SA182-10BSPLP	10	Qal	0.33	1.02E+00	Lab (ASTM D5084)
RSAJ3-10BSPLP	10	Qal	0.34	2.59E-01	Lab (ASTM D5084)
SA64-10BSPLP	10	Qal	0.35	3.45E-02	Lab (ASTM D5084)
SA102-10BSPLP	10	Qal	0.34	2.64E-01	Lab (ASTM D5084)
SA128-10BSPLP	10	Qal	0.38	1.69E-01	Lab (ASTM D5084)
SA148-10BSPLP	10	Qal	0.36	4.64E-01	Lab (ASTM D5084)
RSAQ4-10BSPLP	10	Qal	0.32	1.58E-01	Lab (ASTM D5084)
RSAN8-10BSPLP	10	Qal	0.37	5.22E-01	Lab (ASTM D5084)
RSAQ8-10BSPLP	10	Qal	0.37	1.23E+00	Lab (ASTM D5084)
SA34-10BSPLP	10	Qal	0.36	3.92E-01	Lab (ASTM D5084)
RSAI7-10B	10	Qal	0.38	3.89E-02	Lab (ASTM D5084)
SA52-15BSPLP	15	Qal	0.48	4.44E-01	Lab (ASTM D5084)
RSAU4-20BSPLP	20	Qal	0.36	1.04E+00	Lab (ASTM D5084)
RSAL6-28BSPLP	28	Qal	0.37	4.34E+00	Lab (ASTM D5084)
RSAN8-28BSPLP	28	Qal	0.31	2.26E+00	Lab (ASTM D5084)
SA52-28BSPLP	28	Qal	0.40	1.20E+00	Lab (ASTM D5084)
RSAQ8-31BSPLP	31	Qal	0.52	6.99E-01	Lab (ASTM D5084)
SA34-31BSPLP	31	Qal	0.58	6.34E-02	Lab (ASTM D5084)
Average:			0.38	8.27E-01	

Source: Table 3-4, Northgate 2010. Capture Zone Evaluation Report. December 10.

With the above data, the infiltration rate can be solved for:

$$f_p = K_s(H + L)/L = 0.827(1 \text{ ft} + 22 \text{ ft})/22 \text{ ft} = 0.86 \text{ ft/day}$$

Equation 3

This value represents the estimated maximum infiltration rate for saturated soils.

GROUNDWATER MOUNDING

The saturated soil conductivity represents the maximum infiltration rate that can be achieved under saturated conditions; however the actual infiltration rate will be dependent on the potential for groundwater mounding. When water is added continuously to the subsurface it can begin to mound at low permeability layers, such as the groundwater table, making the infiltrating fluid move horizontally along restricting layer. This is a concern for the pilot test because a large mound may force perchlorate laden flushing fluids outside of the capture zone of the GWETS.

Hantush Equation and Software:

The Hantush Equation is implemented to account for local increases in water table elevations due to engineered infiltration rates, such as installing a recharge basin or soil flushing system:

Equation 4

$$h^2 - h_i^2 = \left(\frac{f_p}{2K_h} \right) (vt) \left[S \left(\frac{1+x}{\sqrt{4vt}}, \frac{a+y}{\sqrt{4vt}} \right) + S \left(\frac{1+x}{\sqrt{4vt}}, \frac{a-y}{\sqrt{4vt}} \right) + S \left(\frac{1-x}{\sqrt{4vt}}, \frac{a+y}{\sqrt{4vt}} \right) + S \left(\frac{1-x}{\sqrt{4vt}}, \frac{a-y}{\sqrt{4vt}} \right) \right]$$

Where:

$$S * (\alpha, \beta) = \text{Integrative term} = \int_0^1 \operatorname{erf} \left(\frac{\alpha}{\sqrt{\tau}} \right) \operatorname{erf} \left(\frac{\beta}{\sqrt{\tau}} \right) d\tau$$

h = Head at given time after recharge begins

h_i = Initial head of aquifer above aquifer base

f_p = Infiltration rate

K_h = Horizontal hydraulic conductivity

$$v = \text{Diffusivity} = \frac{K_h b}{S_y}$$

t = Time elapsed since flushing began

l = Half – length of the recharge basin

a = Half – width of the recharge basin

x = Horizontal distance from the center of the recharge basin

y = Vertical distance from the center of the recharge basin

$$\alpha = \text{Divisional Term 1} = \frac{1+x}{\sqrt{4vt}}, \frac{1-x}{\sqrt{4vt}}; \beta = \text{Divisional Term 2} = \frac{a+y}{\sqrt{4vt}}, \frac{a-y}{\sqrt{4vt}}$$

τ = Integrative variable

erf = Error function

Using the software AQTESOLVE, the hantush equation was solved to estimate the potential for groundwater mounding based on available site data. The following inputs were used to estimate mounding in AQTESOLVE for three infiltration area sizes – 50 feet square, 100 feet square and 150 feet square:

- Depth to groundwater of 22 feet
- Storage coefficient of 0.065
- Infiltration rate = 0.86 ft/day
- Hydraulic conductivity = 35 ft/day (arithmetic mean for the Qa)
- Infiltration time = 100 days (the time to flush 4 pore volumes at the given infiltration rate)

The results from AQTESOLVE were then imported into Surfer to create the plots shown in Figure 1. As seen in Figure 1, there is significant mounding – mounding of greater than 1 foot, 300 feet from the center of infiltration - predicted for both the 100 and 150 foot square areas. However, the 50 foot square scenario is not estimated to cause significant mounding for the anticipated life of the pilot.

These results are estimates and the exact flow rate and infiltration area that causes significant mounding will need to be determined in the field. Since the proposed soil flushing pilot test has the potential to cause significant mounding, piezometers will be installed to monitoring mounding during the pilot test.

Figure 1. Comparison of Mounding as a Function of Design and Hydraulic Conductivity

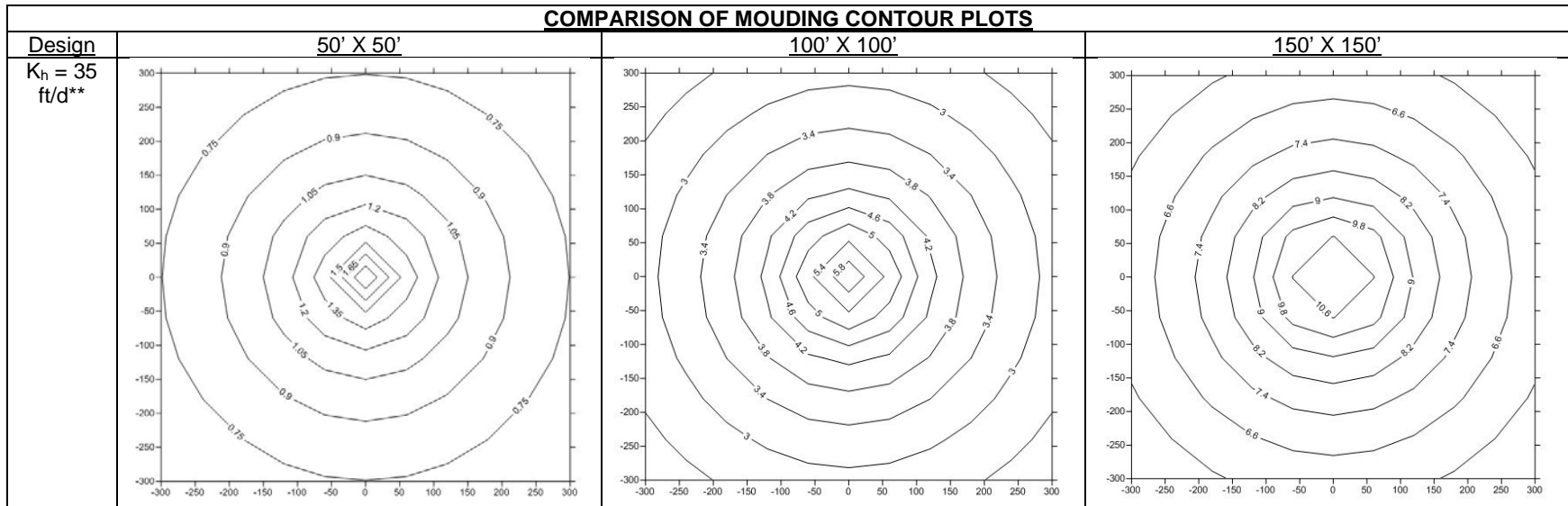

Appendix D

Perchlorate Mass Loading Rate Estimates

Perchlorate Mass Loading Rate Estimates

As discussed in Section 6.1.4, operation of the pilot system will accelerate leaching of constituents from soil to groundwater, which if successful in the field, will increase the influent loading to the GWETS. To assess the potential impacts and aid in the sizing of the pilot system, the following loading rate estimates were calculated using soil mass estimates and the advection-dispersion equation. These estimates will be refined once additional data has been collected as discussed in Section 5 of the Work Plan.

Advection-Dispersion Equation

The analytical solution for 1-D Advection-Dispersion equation (Ogata, 1961) was used to model the movement of perchlorate from the pilot study area to the IWF. It was assumed that the source maintained a constant concentration over the duration of the pilot test (14.4 days based on conservative assumption of 2 pore volumes to flush all perchlorate mass from soil). The perchlorate concentration at specific time and distance is demonstrated by the following equations:

$$A(x, t) = \operatorname{erft}\left(\frac{x - vt}{2\sqrt{Dt}}\right) + \exp\left(\frac{vx}{D}\right) \operatorname{erfc}\left(\frac{x + vt}{2\sqrt{Dt}}\right)$$

$$A(x, t - T) = \operatorname{erft}\left(\frac{x - v(t - T)}{2\sqrt{D(t - T)}}\right) + \exp\left(\frac{vx}{D}\right) \operatorname{erfc}\left(\frac{x + v(t - T)}{2\sqrt{D(t - T)}}\right)$$

$$C(x, t) = \frac{C_0}{2}(A(x, t) - A(x, t - T))$$

where x is distance to source, t is time, T is flushing duration (14.4 days), v is groundwater velocity from the Site Groundwater model (0.33 m/day), C_0 is source concentration (482 g/L), D is dispersion coefficient calculated from groundwater velocity times dispersivity, where dispersivity was determined using the standard assumption of one tenth of the distance from the source to the extraction well (Pickens, 1981).

Model Inputs

The inputs used in the impact assessment were taken from the Site Groundwater model, the 2010 Prima column study report, the 2000 Errol and Montgomery pump test report, soil boring logs for the pilot study area and IWF wells, and IWF operating data.

Mass Estimate

The estimated mass of perchlorate present in the pilot study area is based on a perchlorate concentration (3,138 mg/kg) and soil bulk density (1.725 g/cc) data reported in the Prima pilot study for soil boring RSAM5. RSAM5 is located within the planned pilot study area presented in the Work Plan. The perchlorate concentration from the Prima study was used to provide a conservative estimate of perchlorate mass since this sample would have included soil removed during the 2011 removal action.

The volume of vadose zone in the pilot area was estimated to be 270,000 cubic feet (i.e., using flushing surface area of 10,000 square feet and an average vadose zone depth of 27 feet based on soil borings from the pilot study area before the 2011 remedial action). While the actual

depth of the vadose zone is closer to 20 feet based on the post excavation ground surface and recent water level measurement, the depth of 27 feet is, again, conservative.

The estimated mass of perchlorate in the pilot study area was then calculated by multiplying the perchlorate concentration, bulk density and estimated vadose zone volume of the pilot study area to obtain a total mass of perchlorate of 92,000 pounds.

Mixing Zone Thickness

The source depth used to calculate the source concentration C_0 in the advection-dispersion equation was determined using the mixing zone thickness equation (USEPA, 1996). This equation is sensitive to the source length parallel to groundwater flow. For this evaluation, a conservative value of 60 feet was used to obtain a mixing zone thickness of 2 meters. A larger, more realistic, source length would result in a larger mixing zone and lower modeled impacts to the GWETS.

Results

Table D1 presents the inputs used in the model and the maximum mass loading, and breakthrough concentrations at well I-AR and the other IWF wells. Figure D1 shows the mass loading to the IWF from the pilot test over time, and Figure D2 shows the breakthrough curves for perchlorate concentrations in groundwater at well I-AR and the other IWF wells.

References

Ogata, A., and Banks, R. B. (1961). A solution of the differential equation of longitudinal dispersion in porous media. Professional Paper 411-A, U.S. Geological Survey, Washington, D.C.

Pickens, J. F. and Grisak, G. E. (1981). Modeling of scale-dependent dispersion in hydrogeologic systems. Water Resources Research, 17(6), Page 1701-1711.

USEPA, (1996). Soil Screening Guidance: User's Guide. EPA540/R-96/018, Equation 12

Table D1
Advection-Dispersion Model Inputs
Treatability Study Work Plan, In-Situ Soil Flushing

	Result	Units
Volume of Vadose Zone in the Pilot Area		
Ground Surface Elevation (ft msl)	1,767	ft msl
Groundwater Table Elevation (ft msl)	1,740	ft msl
Thickness of Vadose Zone (ft)	27	ft
Proposed Pilot Test Area (sq ft)	10,000	sq ft
Volume of Vadose Zone (cu ft)	270,000	cu ft
Total Mass of Perchlorate in the Pilot Test Vadose Zone		
Perchlorate Concentration (mg/kg)	3,130	mg/kg
Bulk Density (g/cc)	1.725	g/cc
Bulk Density (kg/cu ft)	48.85	kg/cu ft
Soil Mass in Vadose Zone (kg)	1.32E+07	kg
Perchlorate Mass (mg)	4.13E+10	mg
Perchlorate Mass (kg)	41,280	kg
Perchlorate Mass (lbs)	9.1E+04	lbs
Leaching Rate		
Infiltration rate (ft/d)	0.3	ft/d
Water content of vadose zone (vol/vol)	0.08	vol/vol
Water velocity (ft/d)	3.75	ft/d
Pore volume rate (PV/d)	0.14	PV/d
Total PV Flushed ¹	2	PV
Duration of flushing (d)	14.4	d
Groundwater Mixing Zone Concentration During Pilot Test		
Width of pilot test area (m)	30.48	m
Thickness of groundwater mixing zone (m) ²	2	m
Porosity in groundwater mixing zone (vol/vol)	0.3	vol/vol
Groundwater velocity from model (m/d)	0.33	m/d
Mixing zone groundwater volume (L)	85,698	L
Mixing zone concentration (mg/L) ³	481,695	mg/L
Groundwater Capture		
Groundwater flow rate through mixing zone (L/d)	5,951	L/d
Flow captured by I-AR (%) ⁴	20%	%
Flow captured by I-AR (L/d)	1,190	L/d
Flow captured by other wells in IWF (L/d)	4,761	L/d
Advection-Dispersion Model Results for Perchlorate⁵		
Maximum mass loading	146	lbs/d
Maximum Equivalent Mass Loading ⁶	26	lbs/d
Maximum concentration at Well I-AR	24,273	mg/L
Maximum concentration at Other IWF wells	11,882	mg/L

Table D1
Advection-Dispersion Model Inputs
Treatability Study Work Plan, In-Situ Soil Flushing

Notes:

- 1 Vadose zone is completely flushed after 2 pore volumes (14.4 days)
- 2 Mixing zone thickness was calculated using Equation 12 from the USEPA Soil Screening Guidance: User's Guide, EPA540/R-96/018, July 1996
- 3 Groundwater concentration during pilot test assumed to be constant over 14.4 days of soil flushing
- 4 The fraction of flow captured by I-AR was based on particle tracking results (2 of 10 particles captured by I-AR)
- 5 The analytical solution for 1-D advection-dispersion equation was used to model the movement of perchlorate and obtain the maximum concentration at well I-AR and other IWF wells. (Ogata, 1961)
- 6 The equivalent load of perchlorate from the pilot test is calculated for comparison to the design loading of the GWETS. The GWETS was designed to handle an equivalent load of nitrate, chlorate and perchlorate based on the following equation: Equivalent Load (lbs/day) = $[(0.90 \times \text{NO}_3\text{-N}) + (0.17 \times \text{ClO}_3) + (0.18 \times \text{ClO}_4)] \times Q \times 1440 \times 8.34 / 1,000,000$ (Fluidized Bed Perchlorate Treatment System with Upgrades, Shaw Environmental, September 2006).

Figure D1
Mass Removal Rate by IWF Wells

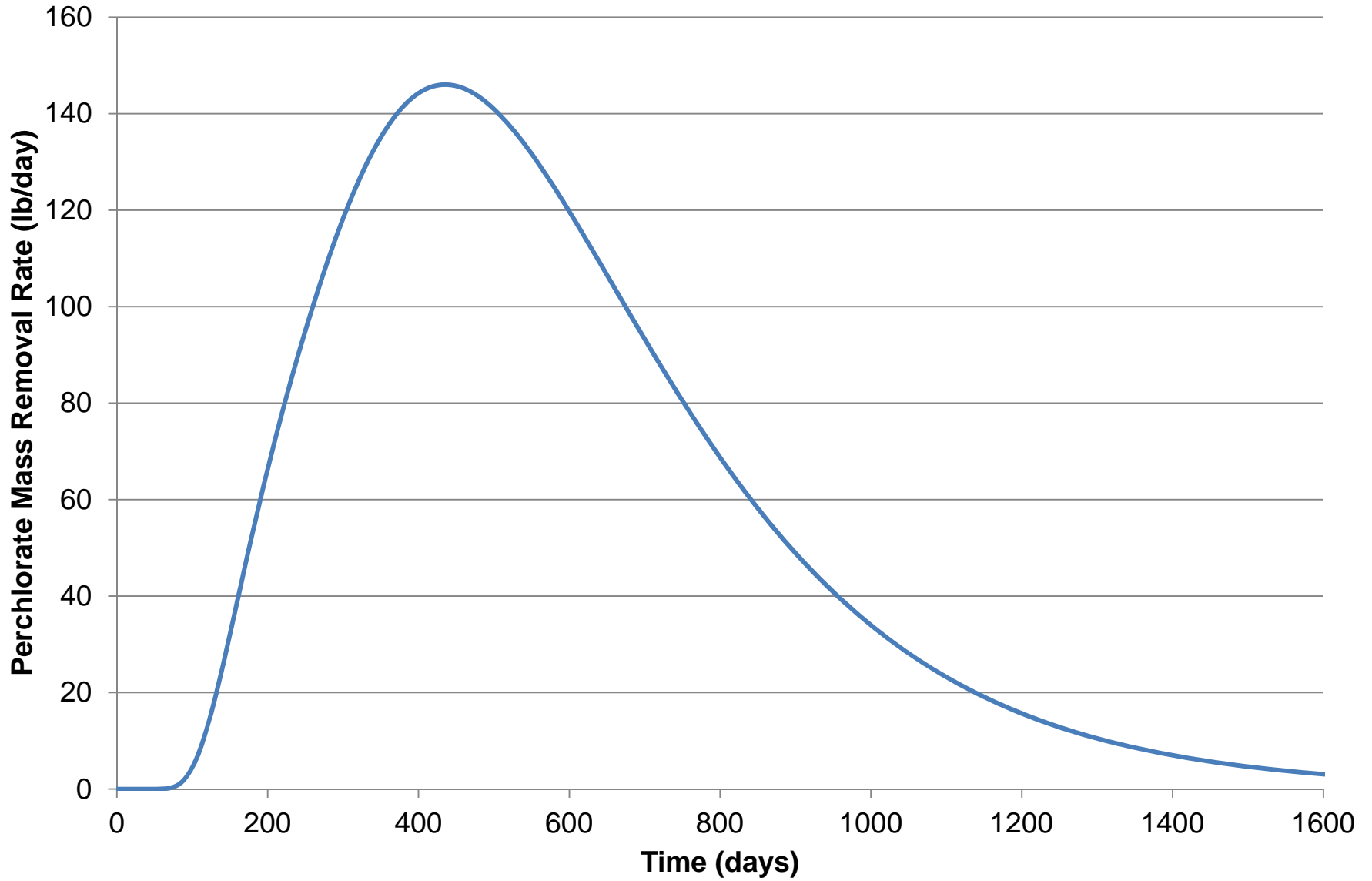

Figure D2
Breakthrough Curve for IWF Wells

